

# DLQ360-USA : 6" SQUARE

CEILING DOWNLIGHT (IP65) 1000LM-2500LM (10W-30W)

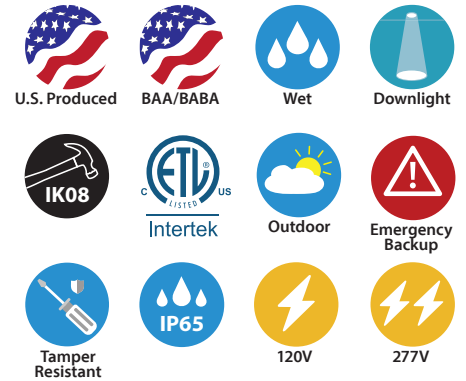
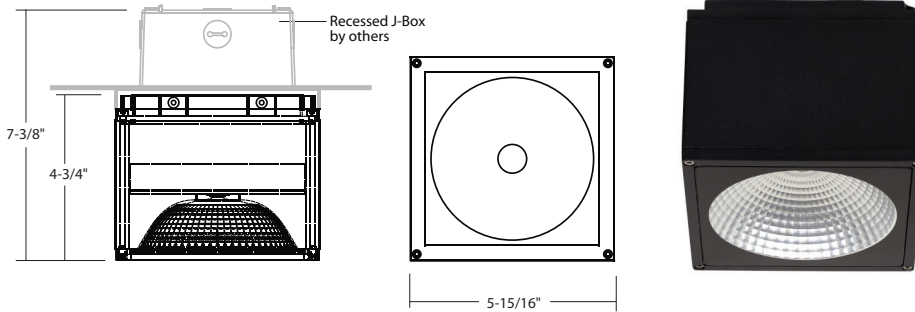

**• Produced in USA**

- 10W Emergency Battery Option
- Energy efficient, low glare LED Chip- On-Board light engine
- 5-Year Limited Warranty
- Exclusive Wall Wash Optics
- Integral J-Box Option
- IK08 Rated

**ORDERING : DLQ360-USAW-L15-B10UE-D10-EM-T30**

**DLQ360-USA**

Fixture      Finish      Lumen      Optics      Control      Emergency Options      LED      Options

Finish		Optics		Control		LED	
White (RAL 9003) <b>W</b>		<i>Standard Beams</i>		Non-Dimming (120V)	<b>Blank</b>	4000K (90 CRI)	<b>Blank</b>
Silver (RAL 7037) <b>S</b>		Wide Flood	<b>Blank</b>	0-10V Dimming (120V/277V)	<b>UE-D10</b>	2700K (90 CRI)	<b>-T27</b>
Bronze (RAL 8019) <b>BZ</b>		Narrow Spot	<b>-B10</b>	<b>Emergency Options</b>		3000K (90 CRI)	<b>-T30</b>
Black (RAL 9005) <b>B</b>		Spot	<b>-B20</b>	None	<b>Blank</b>	3500K (90 CRI)	<b>-T35</b>
Light Silver (RAL 7036) <b>LS</b> <sup>1</sup>		Flood	<b>-B45</b>	10W Emergency Battery	<b>-EM</b>	5000K (80 CRI)	<b>-T50</b>
Dark Grey (RAL 7015) <b>DG</b> <sup>1</sup>		<i>CleanBeam™ Option</i>					
Metallic Gold (RAL 1001) <b>MG</b> <sup>1</sup>		10° Pencil Beam <b>-CB10</b>					
Metallic Black (RAL 7021) <b>MB</b> <sup>1</sup>		<i>Specialty Beams</i>					
<b>Lumen</b>		Wall Wash	<b>-BWW</b>				
1000lm (10W)	<b>Blank</b>	Asymmetric (30° x 60°)	<b>-B3060</b> <sup>2</sup>				
1500lm (15W)	<b>-L15</b>						
2200lm (22W)	<b>-L20</b>						
2500lm (30W)	<b>-L26</b>						
						<b>Options</b>	
						None	<b>Blank</b>
						Frosted Lens	<b>-FR</b>
						Integral Junction Box	<b>-JB</b>
						Hex-Cell Louver	<b>-LVR</b> <sup>3</sup>
						Photocell Sensor	<b>-SDL</b> <sup>2</sup>
						Surge Protector	<b>-SRG</b>

<sup>1</sup> Special Order Finish. Minimum order quantity (MOQ) applies. Orders less than MOQ are subject to a special paint set-up fee for the quantity ordered. Extended lead times may apply. Consult Factory.

<sup>2</sup> Special Order. Minimum order, extended lead time may apply. Consult factory.

<sup>3</sup> (-LVR) Hex-Cell Louver is not compatible with CleanBeam Option (-CB10).

Custom RAL Color: Please note that we appreciate custom finishes. Custom finishes are subject to a special paint setup fee for the quantity ordered. Extended lead times may apply. Consult Factory.

## SPECIFICATION

### Application

This DL series covered ceiling mount downlight can be used for surface ceiling or pendant mount in both interior and outdoor settings. Typical locations are in commercial and retail spaces that require lighting from above. Dark sky compliant.

### Housing

Housing is constructed from a square one piece high grade aluminum extrusion.(Alloy 6061 <04% Cu). Faceplate (with a tempered glass lens) and top cap are of a robust die-cast aluminum alloy and are secured to the housing with (4)socket head tamper resistant stainless steel screws and seal the housing (top and bottom) using silicone gaskets. Free of burrs and sharp corners and edges.

### Mounting:

A mounting bracket attaches to or over a recessed J-Box (by others) and has through holes to accept (4) four countersunk phillips head screws in the top edge of the fixture housing.

### Finish:

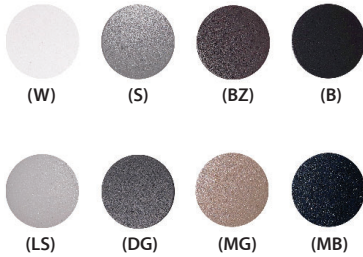

A 7-stage electrostatic, polymer process provides an outdoor textured powder coat finish that delivers outstanding durability, superior anti-aging, resistance to corrosion and UV-degradation. Consult factory for Custom Color. (More Information)

#### Standard Finishes:

White: *RAL 9003* (W)  
 Silver: *RAL 7037* (S)  
 Bronze: *RAL 8019* (BZ)  
 Black: *RAL 9005* (B)

#### Special Order Finishes:

Light Silver: *RAL 7036* (LS)  
 Dark Gray: *RAL 7015* (DG)  
 Metallic Gold: *RAL 1001* (MG)  
 Metallic Black: *RAL 7021* (MB)

### Certifications and Listings:



ETL / cETL Listed to UL1598 and UL8750 standards.

Suitable wet locations. (IP65)

Produced in USA.

IK08 rated for impact resistance.

Dark Sky compliant.

Meets NFPA 70/NEC Code on Listings.

### Control

(UE-D10) 0-10V dimming works with most 5-wire, 0-10V dimmers. Factory qualified for use with Leviton IP710-DLZ.

## SPECIFICATION (Continued)

**Caution:** LITON recommends use of surge protectors on the power entering LED Housings. Surge damage is not covered by warranty. (See option SRG)

**Warranty**

Covered by a 5-Year Warranty to be free of defects in materials and craftsmanship. Fixture should not be installed in applications with ambient temperature above 50°C/122°F. Doing so will result in reduced lamp life and voided warranty.

**Optics**

Multifaceted aluminum reflectors produce low glare illumination with multiple light control options.

**Standard Beam:**

Used for maximum light output and visible field angle.

**CleanBeam™:**

Used for a direct uniform light output with minimized field angle and to enhance building aesthetics.

**LED**

COB (Chip on Board) singular LED light source provides for smooth, uniform light output, eliminating the imaging produced by multiple LED source optics.

**Lumen Maintenance:**

Lumen Maintenance is a minimum 50,000 hours L70 life based on ANSI TM-21 calculations from LM80 standardized test results.

**Lumen Options (Nominal):**

1000lm (10W) (Blank)  
 1500lm (15W) (-L15)  
 2200lm (22W) (-L20)  
 2500lm (30W) (-L26)

**Color Temperature:**

Binned with 4-step MacAdam ellipses as per ANSI Standard recommendation.

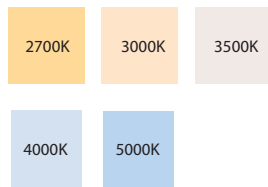

COLOR TEMP:	2700K	3000K	3500K	4000K	5000K
CRI:	90	90	90	90	90

**Electrical**

LED Driver: AC 50/60Hz Electronic Direct Current Class 2 driver integrally mounted. Power Factor shall be >90% at full load with THD <20% at full load. Electrical Output shall be isolated. See Dimming Section for voltage and wiring.

Minimum Operating Temperature:  
 Standard: -10°C/14°F

## SPECIFICATION (Continued)

### Emergency Options

Emergency LED Battery Back-up available, remotely mounted adjacent to to housing by installer. When AC power fails, the device immediately switches to the emergency mode, operating the LEDs for a minimum of 90 minutes. Remote test switch, plate cover and junction box included.

### Dimming Options

#### 0-10V Driver 120V/277V (UE-D10):

Compatible with most existing 0-10V systems. Also known as fluorescent or 5-Wire dimming. Allows smooth dimming down to 5% depending upon the dimmer's limitations. Compatible with daylight harvesting controls.

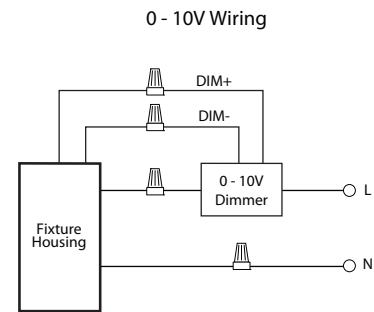

### EMERGENCY BATTERY (-EM): 10W

- Must be installed in Dry Locations
- 10W constant output to LED lamp

**Not rated for outdoor mounting. Damp location rated.**

#### -EM Lumen Data (Battery)

Fixture/Trim	DLQ360-USAW
Fixture Wattage:	10W
Fixture Lumens:	1000
Multiplier:	0.59
EM Lumens:	590

Fixture/Trim	DLQ360-USAW-L15
Fixture Wattage:	15W
Fixture Lumens:	1500
Multiplier:	0.67
EM Lumens:	1000

Fixture/Trim	DLQ360-USAW-L20
Fixture Wattage:	22W
Fixture Lumens:	2200
Multiplier:	0.45
EM Lumens:	990

Fixture/Trim	DLQ360-USAW-L26
Fixture Wattage:	30W
Fixture Lumens:	2500
Multiplier:	0.33
EM Lumens:	830

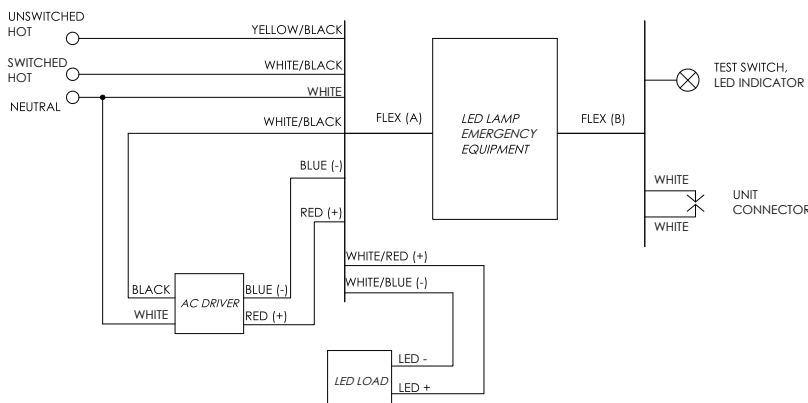

Input Voltage:	120-277VAC/60Hz
Output Voltage:	10W
Wattage:	10W
Switching Time:	<1s
Charging Time:	24h
Operating Time:	90 minutes
Minimum Temperature:	0°C
Maximum Temperature:	50°C
Self-Diagnostic:	No

## SPECIFICATION (Continued)

### Additional Options

#### Optional J-Box (Direct Conduit Entry):

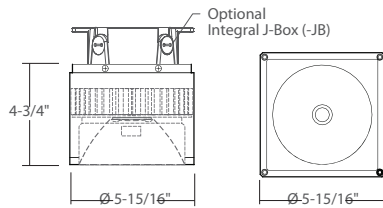

For use with mounting locations without a recessed junction box.  
 Factory installed outlet box with five (5) 1/2 NPSM trade conduit holes and plugs (1 top, 4 sides) for 1/2 in. trade conduit and wire entry. Hexcell Louver (-LVR): 3 mm / .125" (size of the cells) - matte black finish, 45° glare cutoff, unframed.

#### Configure as:

-JB: (5) conduit entry from left or right looking at fixture

#### Photocell (/SDL):



Sensor enables automatic on/off operation based on ambient light levels, providing dusk-to-dawn functionality.

Power Consumption: .5W

Voltage: 120V, 277V

On/Off Levels: On @ 0-2fc / Off @ 2fc or more

Warranty: 2-Year / 5,000 Cycles

Sensor Size: 3/8"

Rating: UL/cUL

#### Surge Suppressor (/SRG):



Protects driver against surges in line voltage/current (20KV, 1.2/50µS & 10KA, 8/20µS).

Provides a positive indication of end-of-life by opening voltage to the load.

Surge suppressor is a perishable device requiring periodic replacement.

Not a warranted item.

#### Pendant Mounting:

See spec sheet [LPCMDLQ6](#) for details and configuration

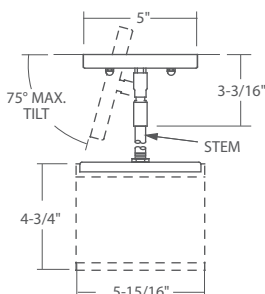

## PHOTOMETRY - DLQ360-USA (L26) (Continued)

### Footcandle Distribution Cone Charts

STANDARD BEAM – WIDE FLOOD (Blank)

Height	Beam Diameter	Footcandle (FC)*
6.0'	10.0'	37.4
8.0'	13.3'	21.1
10.0'	16.6'	13.5
12.0'	19.9'	9.4
14.0'	23.2'	6.9

\*at center of beam

STANDARD BEAM – NARROW SPOT (-B10)

Height	Beam Diameter	Footcandle (FC)*
6.0'	1.9'	245.2
10.0'	3.1'	88.3
14.0'	4.4'	45.0
18.0'	5.7'	27.2
20.0'	6.3'	22.1

\*at center of beam

STANDARD BEAM – SPOT (-B20)

Height	Beam Diameter	Footcandle (FC)*
6.0'	2.0'	216.0
8.0'	2.6'	121.5
10.0'	3.3'	77.8
12.0'	3.9'	54.0
14.0'	4.6'	39.7

\*at center of beam

STANDARD BEAM – FLOOD (-B45)

Height	Beam Diameter	Footcandle (FC)*
6.0'	3.8'	105.1
8.0'	5.1'	59.1
10.0'	6.3'	37.8
12.0'	7.6'	26.3
14.0'	8.9'	19.3

\*at center of beam

### Footcandles On Ground (2 - Fixture Overlap)

5.0 fc 2.0 fc 1.0 fc .5 fc

STANDARD BEAM – WIDE FLOOD (Blank)  
8' Mounting

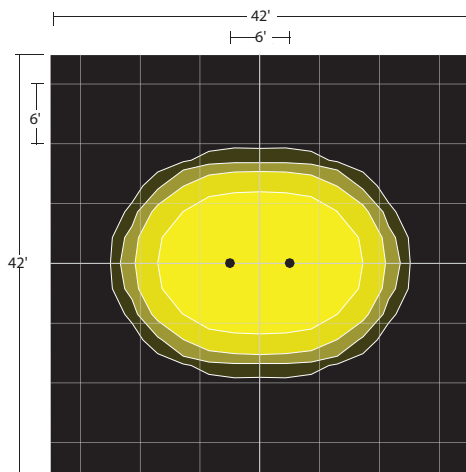

STANDARD BEAM – WIDE FLOOD  
16' Mounting

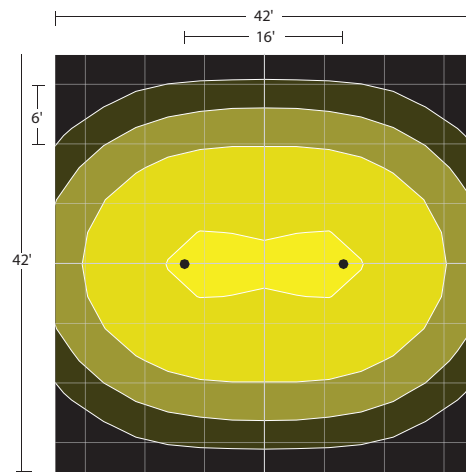

SPECIALTY BEAM – TYPE IV (-BIV)  
8' Mounting

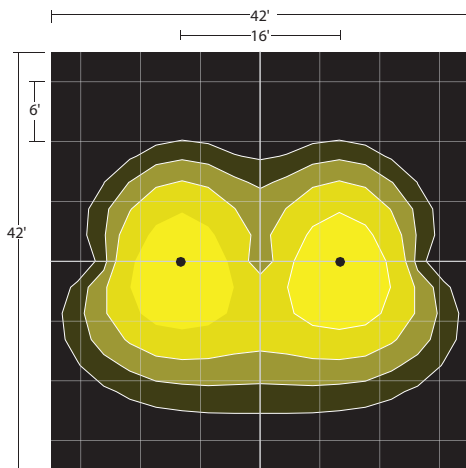

SPECIALTY BEAM – TYPE IV (-BIV)  
16' Mounting

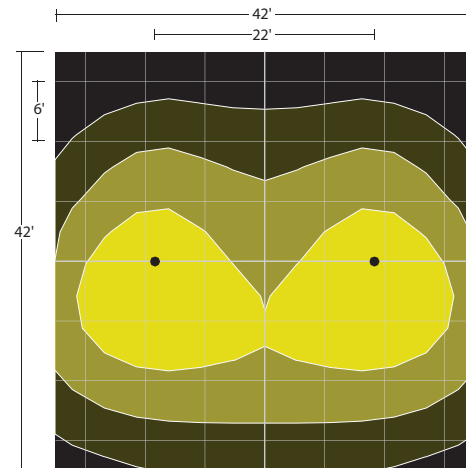

2023.07.18

## PHOTOMETRY - DLQ360-USA (L26) (Continued)

Footcandles On Ground (2 - Fixture Overlap)

5.0 fc   2.0 fc   1.0 fc   .5 fc

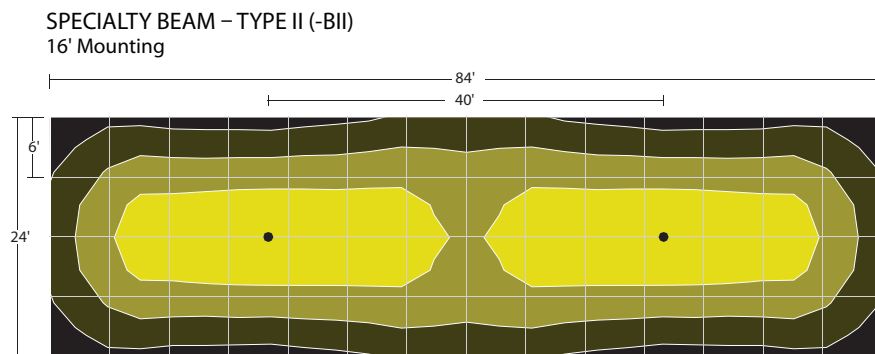
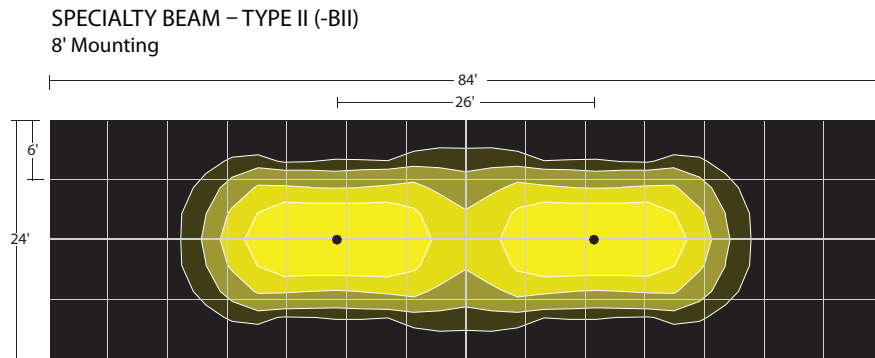

## LUMEN OUTPUT / LPW /BUG RATING

LM	W	Beam Spread	-T27 (2700K, 90 CRI)					-T30 (3000K, 90 CRI)					-T35 (3500K, 90 CRI)					Blank (4000K, 90 CRI)					-T50 (5000K, 80 CRI)									
			LM	LPW	cd	B	U	G	LM	L/W	cd	B	U	G	LM	LPW	cd	B	U	G	LM	LPW	cd	B	U	G	LM	LPW	cd	B	U	G
1000 lm	14.3	Wide Flood	959	67	728	1	0	0	998	70	758	1	0	0	1012	71	769	1	0	0	1014	71	770	1	0	0	1208	84	918	1	0	0
		-B02	317	22	612	1	0	0	330	23	637	1	0	0	334	23	646	1	0	0	335	23	647	1	0	0	399	28	771	1	0	0
		-CB20	284	20	647	1	0	0	295	21	674	1	0	0	300	21	683	1	0	0	300	21	684	1	0	0	358	25	816	1	0	0
		-CB35	448	31	666	1	0	0	466	33	694	1	0	0	472	33	703	1	0	0	473	33	705	1	0	0	564	39	840	1	0	0
		-B10	1134	79	6116	2	0	0	1180	83	6367	2	0	0	1197	84	6456	2	0	0	1199	84	6468	2	0	0	1429	100	7708	2	0	0
		-B20	929	65	5788	2	0	0	968	68	6026	2	0	0	981	69	6110	2	0	0	983	69	6122	2	0	0	1171	82	7295	2	0	0
		-B45	968	68	2351	2	0	0	1008	70	2448	2	0	0	1022	71	2482	2	0	0	1024	72	2487	2	0	0	1220	85	2964	2	0	0
		-BII	951	67	927	1	0	0	990	69	966	1	0	0	1004	70	979	1	0	0	1006	70	981	1	0	0	1199	84	1169	1	0	0
		-BWW	834	58	653	1	0	0	868	61	680	1	0	0	880	62	689	1	0	0	882	62	691	1	0	0	1051	73	823	1	0	0
-BIV	834	58	653	1	0	1	868	61	680	1	0	1	880	62	689	1	0	1	882	62	691	1	0	1	1051	73	823	1	0	1		
-L15 (1500 lm)	13.9	Wide Flood	1296	93	576	1	0	0	1350	97	600	1	0	0	1368	98	608	1	0	0	1371	99	609	1	0	0	1634	118	726	1	0	0
		-B02	403	29	484	1	0	0	419	30	504	1	0	0	425	31	511	1	0	0	426	31	512	1	0	0	507	37	610	1	0	0
		-CB20	361	26	512	1	0	0	375	27	533	1	0	0	381	27	541	1	0	0	381	27	542	1	0	0	454	33	645	1	0	0
		-CB35	569	41	528	1	0	0	593	43	549	1	0	0	601	43	557	1	0	0	602	43	558	1	0	0	717	52	665	1	0	0
		-B10	1237	89	4157	2	0	0	1288	93	4328	2	0	0	1306	94	4389	2	0	0	1309	94	4397	2	0	0	1560	112	5240	2	0	0
		-B20	1316	95	4157	2	0	0	1370	99	4328	2	0	0	1389	100	4389	2	0	0	1392	100	4397	2	0	0	1659	119	5240	2	0	0
		-B45	1303	94	1912	2	0	0	1356	98	1990	2	0	0	1375	99	2018	2	0	0	1378	99	2022	2	0	0	1642	118	2410	2	0	0
		-BII	1241	89	754	1	0	0	1292	93	784	1	0	0	1310	94	795	1	0	0	1313	94	797	1	0	0	1564	113	950	1	0	0
		-BWW	1059	76	517	1	0	0	1103	79	538	1	0	0	1118	80	546	1	0	0	1121	81	547	1	0	0	1333	96	650	1	0	0
-BIV	1059	76	517	1	0	1	1103	79	538	1	0	1	1118	80	546	1	0	1	1121	81	547	1	0	1	1335	96	652	1	0	1		
-L20 (2000 lm)	19.5	Wide Flood	2135	109	816	1	0	0	2223	114	849	1	0	0	2254	116	861	1	0	0	2258	116	863	1	0	0	2691	138	1028	1	0	0
		-B02	654	34	667	1	0	0	681	35	694	1	0	0	690	35	704	1	0	0	691	35	705	1	0	0	824	42	840	1	0	0
		-CB20	585	30	705	1	0	0	609	31	734	1	0	0	618	32	744	1	0	0	619	32	746	1	0	0	738	38	888	1	0	0
		-CB35	923	47	726	1	0	0	961	49	755	1	0	0	975	50	766	1	0	0	976	50	768	1	0	0	1164	60	915	1	0	0
		-B10	2022	104	6490	2	0	0	2106	108	6756	2	0	0	2135	109	6851	2	0	0	2139	110	6864	2	0	0	2549	131	8180	2	0	0
		-B20	1759	90	5680	2	0	0	1831	94	5913	2	0	0	1857	95	5996	2	0	0	1860	95	6007	2	0	0	2217	114	7159	2	0	0
		-B45	1776	91	2665	2	0	0	1849	95	2775	2	0	0	1874	96	2814	2	0	0	1878	96	2819	2	0	0	2238	115	3360	2	0	0
		-BII	1998	102	1029	1	0	0	2080	107	1071	1	0	0	2109	108	1086	1	0	0	2113	108	1088	1	0	0	2518	129	1297	1	0	0
		-BWW	1768	91	731	1	0	0	1840	94	761	1	0	0	1866	96	772	1	0	0	1870	96	774	1	0	0	2228	114	922	1	0	0
-BIV	1768	91	731	1	0	1	1840	94	761	1	0	1	1866	96	772	1	0	1	1870	96	774	1	0	1	2228	114	922	1	0	1		
-L26 (2500 lm)	29.3	Wide Flood	2730	93	1087	1	0	0	2842	97	1132	1	0	0	2882	98	1148	1	0	0	2887	99	1150	1	0	0	3441	117	1370	1	0	0
		-B02	857	29	913	1	0	0	893	30	951	1	0	0	905	31	964	1	0	0	907	31	966	1	0	0	1081	37	1151	1	0	0
		-CB20	767	26	964	1	0	0	798	27	1004	1	0	0	810	28	1018	1	0	0	811	28	1020	1	0	0	967	33	1216	1	0	0
		-CB35	1212	41	995	1	0	0	1261	43	1036	1	0	0	1279	44	1050	1	0	0	1281	44	1052	1	0	0	1527	52	1254	1	0	0
		-B10	2494	85	8346	2	0	0	2597	89	8689	2	0	0	2633	90	8810	2	0	0	2638	90	8827	2	0	0	3144	107	10519	2	0	0
		-B20	2306	79	7351	2	0	0	2401	82	7653	2	0	0	2434	83	7760	2	0	0	2439	83	7775	2	0	0	2907	99	9266	2	0	0
		-B45	2315	79	3578	2	0	0	2410	82	3725	2	0	0	2443	83	3777	2	0	0	2448	84	3784	2	0	0	2917	100	4510	2	0	0
		-BII	2567	88	1380	1	0	0	2672	91	1437	1	0	0	2710	92	1457	1	0	0	2715	93	1460	1	0	0	3235	110	1740	1	0	0
		-BWW	2256	77	975	1	0	0	2349	80	1015	1	0	0	2381	81	1029	1	0	0	2386	81	1031	1	0	0	2838	97	1226	1	0	0
-BIV	2256	77	975	1	0	1	2349	80	1015	1	0	1	2381	81	1029	1	0	1	2386	81	1031	1	0	1	2843	97	1229	1	0	1		