

JX1012S - VERTICAL INTERJACK DROP PENDANT

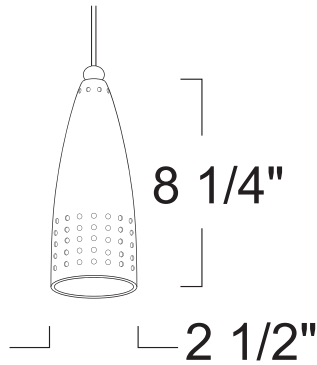

SPECIFICATION

12V 50W MR16 GU5.3









Application: Add a touch of elegance to your design and make an architectural statement. These attractive pendants create a signature look to any environment.

InterJack System: Connection plug allows for utilizing a variety of mounting options with the same glass design. See compatibility chart for different methods. All hardware included in product packaging.

Cable Length: Available in 24", 36", 48", 60" and 72".

Label: cETL Listed

COMPATIBILITY

 L20HT POWER POINT INTERJACK ADAPTER	 L4P LH1499 INTERJACK ADAPTER	 L4PR LH99 INTERJACK ADAPTER
 L6P LH7LV INTERJACK ADAPTER	 L6PR LH7 INTERJACK ADAPTER	 LFCJ FLEXICURVE™ INTERJACK ADAPTER
 LPE CANOPY INTERJACK ADAPTER	 LT TRACK INTERJACK ADAPTER	

Note: Wattage limitations on compatible items must be met.

FEATURE:



ORDERING EXAMPLE : JX1012S-24

JX1012S	CABLE LENGTH
JX1012S	-24 :24"
	-36 :36"
	-48 :48"
	-60 :60"
	-72 :72"

ID#: 1230