

WS497 : 5" x 11" DARKLIGHT SURFACE WALL LIGHT 1200LM (14W)

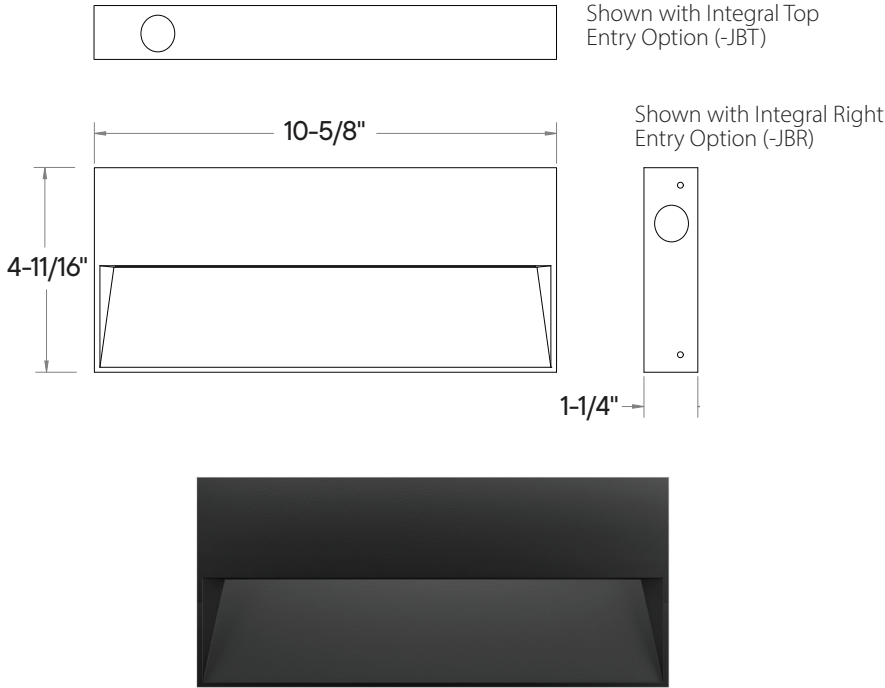

- Low Glare
- Fully Die-Cast Aluminum
- Marine Grade Finishes
- Amber LED Option (590nm, NOT PC amber)
- ADA Compliant
- Dark Sky Compliant
- IP65 Rated
- IK10 Rated
- Integral Daylight + Motion Sensor (UNISENSE)
- Inconspicuous LED Layout
- Achieve up to 10' Fixture Spacing at 3' Mounting Height while maintaining a min. of 2 fc at egress

ORDERING : WS497B-BIVUE-D10-T27-JBL

Fixture	Finish	Optics	Control	Color Temperature	Emergency Options	Options
Fixture		Optics		Color Temperature		Options
5" X 11" Darklight Surface Wall Light 1200lm (14W)	WS497	Standard Forward Throw (Type-IV)	Blank BIV¹	2700K (80CRI) -T27 3000K (80CRI) -T30 3500K (80CRI) -T35 4000K (80CRI) -T40 Limited Wavelength (590nm) -TAM¹	None Blank Remote Emergency Inverter (25W) -EMAC³	None Blank Marine Grade Finish -MGD² Integral Junction Box Left Entry -JBL Integral Junction Box Right Entry -JBR Integral Junction Box 2-Entries -JB2 Integral Junction Box Top Entry -JBT
Finish		Control				
Black B White W² Bronze BZ Silver S²		TRIAC/ELV Dimming (120V) Blank 0-10V Dimming (120V/277V) UE-D10 UniDim™ 0-10V, TRIAC/ELV Dimming (120V/277V) UE-DUN 1%, 0-10V Dimming (120V/277V) UE-D10P1 UniSense - Integral Motion/ Photosensor (120V/277V) -SUN-INT-1227				

¹ Special Order. Minimum order, extended lead time may apply. Consult factory.

² Special Order Finish. Minimum order quantity (MOQ) applies. Orders less than MOQ are subject to a special paint set-up fee for the quantity ordered. Extended lead times may apply. Consult Factory.

³ Check Wiring Diagram for Remote Emergency Backup.

SPECIFICATION

Application

Surface mount Luminaire ideal for indoor or outdoor applications in residential, commercial, or architectural installations. Can be used to direct and guide as well as supply lighting for security.

Housing

Constructed from 2-piece high grade die cast aluminum with a powder coat finish. Removable backplate with wire and IP65 cable glands.

Mounting

Aluminum Backplate can be removed and mounted with the appropriate mounting screws for the surface material. Once the backplate is mounted, the faceplate can be installed and fastened via set screw.

Finish

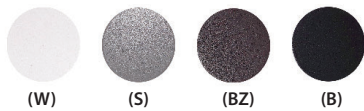

A 7-stage electrostatic, polymer process provides an outdoor textured powder coat finish that delivers outstanding durability, superior anti-aging, resistance to corrosion and UV-degradation. Consult factory for Custom Color. (More Information).

Standard Finishes:

White: *RAL 9003* (W)
Silver: *RAL 7037* (S)
Bronze: *RAL 8019* (BZ)
Black: *RAL 9005* (B)

Certifications and Listings



ETL / cETL Listed to UL1598 and UL8750 standards.

Suitable wet locations. (IP65)

ADA compliant and suitable for installation within 4ft of the ground.

LED



Color Temperature: Available in 2700K, 3000K, 3500K, 4000K, 5000K, 80 CRI standard.

Lumen Maintenance

Lumen Maintenance: Lumen Maintenance is minimum 50,000 hours L70 life based on ANSI TM-21 calculations from LM80 standardized test results.

SPECIFICATION (Continued)

Warranty

Covered by a 5-Year Warranty to be free of defects in materials and craftsmanship. Fixture should not be installed in applications with ambient temperature above 50°C/122°F. Doing so will result in reduced lamp life and voided warranty.

Emergency Options

Emergency LED Battery Back-up available, remotely mounted adjacently by the installer. When AC power fails, the device immediately switches to the emergency mode, operating the LEDs for a minimum of 90 minutes. Remote test switch and plate cover included. Optional Generator Transfer Device switches the driver to auxiliary generator power during the loss of normal AC power, (recommended for applications requiring individual circuit switching).

Additional Options

Optional J-Box (Direct Conduit Entry):

For use with mounting locations without a recessed junction box. Allows for direct mounting to building surface. Arm may be configured for up to 3 conduit entries (1/2") total; 2 on the sides, 1 on top. .

Configure as:

- JBL: (1) conduit entry from left side looking at fixture
- JBR: (1) conduit entry from right side looking at fixture
- JB2: (2) conduit entry on sides
- JBT: (1) conduit entry on top

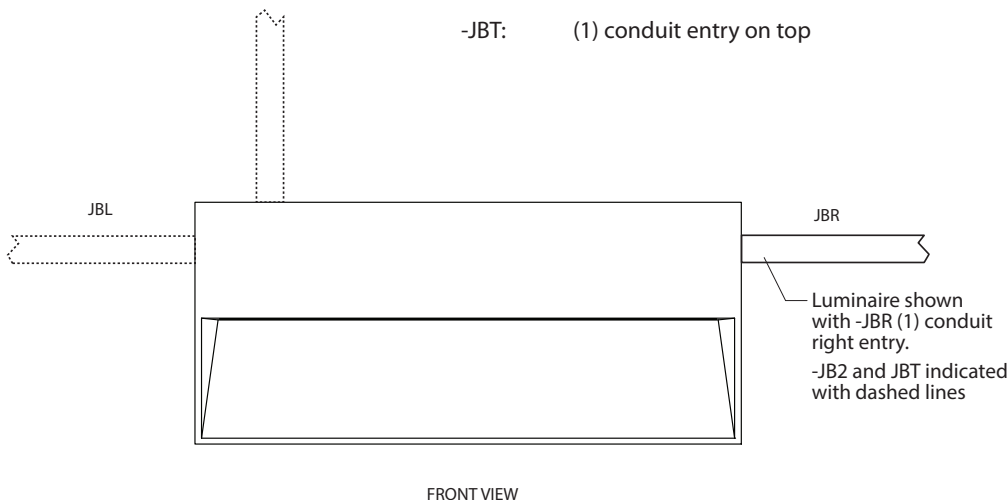

SPECIFICATION (Continued)

EMERGENCY BATTERY (-EM): 15W

- Must be installed in Dry Locations
- 10W constant output to LED lamp

Not rated for outdoor mounting. Damp location rated.

-EM Lumen Data (Battery)

Fixture/Trim	WS497
Fixture Wattage:	15W
Fixture Lumens:	1000
EM Lumens:	1000

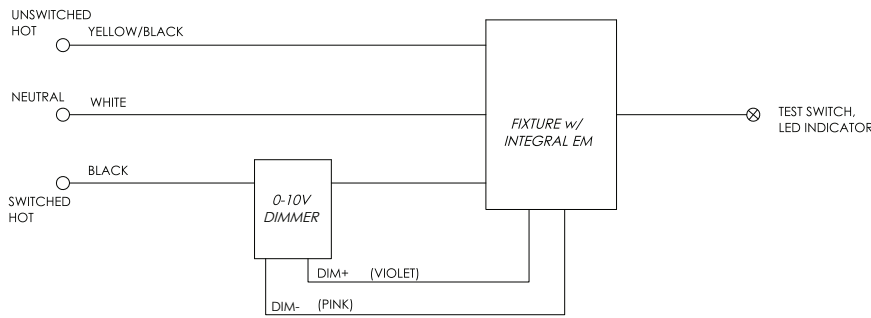

Input Voltage:	120-277VAC/60Hz
Output Voltage:	10W
Wattage:	10W
Switching Time:	<1s
Charging Time:	24h
Operating Time:	90 minutes
Minimum Temperature:	0°C
Maximum Temperature:	50°C
Self-Diagnostic:	No

SPECIFICATION (Continued)

Controls

ELV and TRIAC Driver 120V (-DIN):

Compatible with electronic low voltage, and 2-Wire incandescent dimmers. Also known as leading edge, Reverse Phase, Forward Phase dimming. Allows smooth dimming down to 5% depending upon the dimmer's limitations.

0-10V Driver 120V/277V (UE-D10):

Compatible with most existing 0-10V systems. Also known as fluorescent or 5-Wire dimming. Allows smooth dimming down to 5% depending upon the dimmer's limitations. Compatible with daylight harvesting controls.

UniDim™ Driver 120V/277V (UE-DUN):

All in one ELV and TRIAC phase dimming (120V only), and 0-10V dimming (120V/277V). Works with most 3-Wire ELV, 2-Wire incandescent and 120V/277V 5-Wire 0-10V fluorescent dimmers.

Incandescent/Phase Wiring
ELV

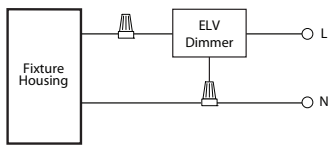

TRIAC

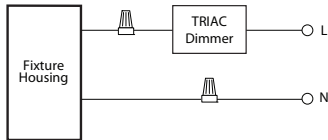

0 - 10V Wiring

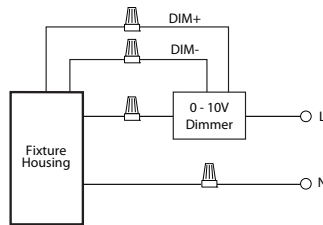

Incandescent/Phase Wiring
ELV

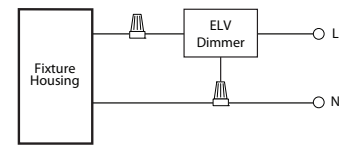

TRIAC

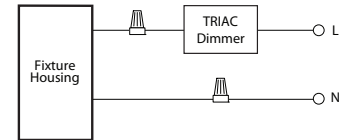

0 - 10V Wiring

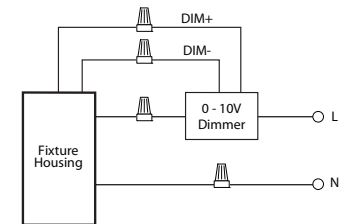

Unisense™ PROGRAMMABLE MOTION + DAYLIGHT (-SUN-RMT, -SUN-RMT-1227)

- Microwave and PIR (Passive Infrared) sensors depending on option
- Daylight harvesting
- Dusk/dawn sensing capabilities
- Motion Sensor

13' Height

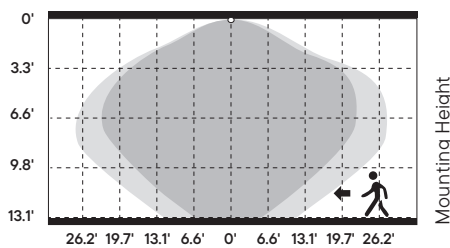

13.1 ft max. distance with 100% sensitivity

50' Height

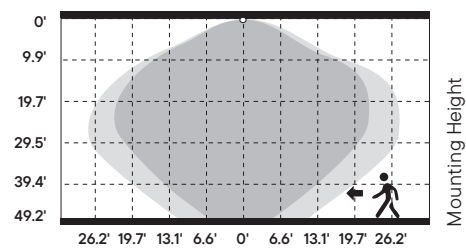

49.2 ft max. distance with 100% sensitivity



PHOTOMETRY

WS497B-T40 (1200lm, 14W, 4000K, CRI 80)

System Power:	14.1W	MULTIPLIERS	
Test Date:	04/2025	2700K	0.88
Beam Angle 50%:	98.7°	3000K	0.93
Field Angle 10%:	143.0°	3500K	0.96
Color Temperature:	4081K	4000K	1.00
CRI:	83.1		
Lumens Delivered:	1080		
CBCP:	449.71		
Power Factor:	0.99		

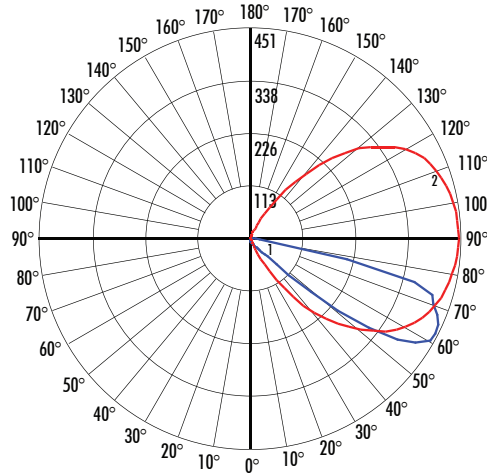

Maximum Candela = 451.17 Located At Horizontal Angle = 2.5, Vertical Angle = 62.5
 # 1 - Vertical Plane Through Horizontal Angles (2.5 - 182.5) (Through Max. Cd.)
 # 2 - Horizontal Cone Through Vertical Angle (62.5) (Through Max. Cd.)

2 fc 1 fc .5 fc .2 fc .1 fc

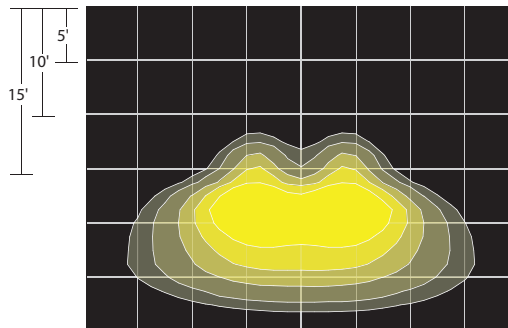

FOOTCANDLES ON GROUND
 2 Fixture Overlap, 10 Ft. Spacing
 3 Ft. Light Source Mtg. Ht., 1080 lm

2025.04.11

BUG RATING	B0-U0-G1	
FRONT	Lumens	Lumens %
Low (0-30°)	6.9	1.9%
Medium (30°-60°)	103.7	28.6%
High (60°-80°)	227.1	62.7%
Very High (80°-90°)	12.0	3.3%
BACK		
Low (0-30°)	3.6	1.0%
Medium (30°-60°)	6.2	1.7%
High (60°-80°)	2.3	0.6%
Very High (80°-90°)	0.4	0.1%
UPLIGHT		
Low (90°-100°)	0.0	0.0%
High (100°-180°)	0.0	0.0%

LCS GRAPH

