

# DCG 3/4/5

## Remarkable Installation Savings

Up 60% faster installation  
Over 40% material cost saving

### Wire Diagram:



## GridLyte is compatible with 1/2" to 1" T-Bar Profiles

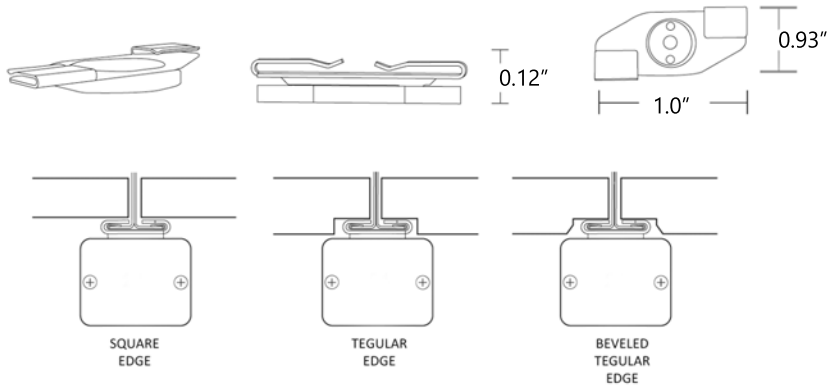

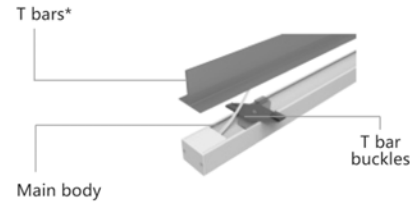

## An innovative lighting product solution for T-Grid suspension ceilings

### Product Line Drawing :

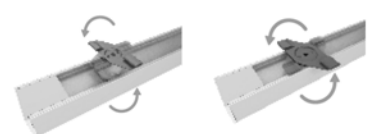
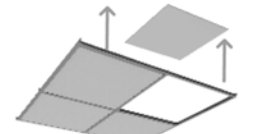
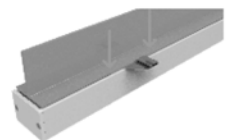

\* T bar is not included in the product packaging. The T bar is apart of the ceiling. It is not neccessary to modify the T bar to insatall T Grid Lighting System.

### Installation steps:

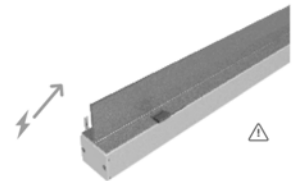
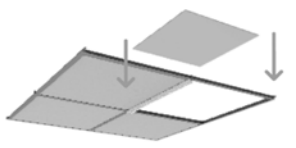
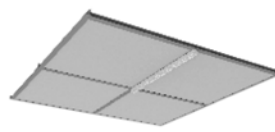
-  1. Move the hanger toward to the end cap as much as possible and turn the hanger vertically to the light fitting.
-  2. Remove the tiles from the T grid for easy installation.
-  3. Place Fixture under the T bar closely.
-  4. Turn the hanger clockwise and lock the hanger to the T bars.
-  5. Place the Low Voltage cable alongside the T bar and connect to power Supply.
-  6. Place the tiles back to the ceiling.
-  7. Now the installation is completed.