



INTRODUCTION

LITON's outdoor lighting collections are designed to be among the most cohesive and versatile in the industry. We focus on design consistency across all our products to create a harmonious look for your outdoor spaces. Our eight core commitments ensure we provide effective and responsible lighting solutions for any outdoor environment.

Our Eight Core Commitments

1. Purposeful Lighting:

Every light should serve a clear purpose. That's why we offer a wide range of beam spreads, shapes, and colors to meet different needs.

2. Focused Illumination:

Light should only be directed where it's needed. Our fixtures are tiltable and rotatable for precise and intentional lighting.

3. Optimal Brightness:

Lighting should not be brighter than necessary. We offer multiple lumen options to achieve the perfect balance of brightness.

4. Energy Efficiency:

Lights should be dimmed or turned off when not in use. We support all standard dimming options, including 0-10V, Triac (Forward Phase), and (ELV - Reverse Phase) dimming.

5. Warm Color Temperature:

Use warmer light colors whenever possible. Our standard fixtures come with 2700K color temperatures for a welcoming ambiance.

6. U.S. Assembled:

We assemble our products in the USA and source components locally when possible to ensure quality and reliability.

7. Environmentally Friendly Options:

We offer Turtle Safe and Dark Sky-compliant fixtures to protect wildlife, and our nighttime skies.

8. Available for Canadian Markets:

All our exterior lighting products are available in 347V for the Canadian market.

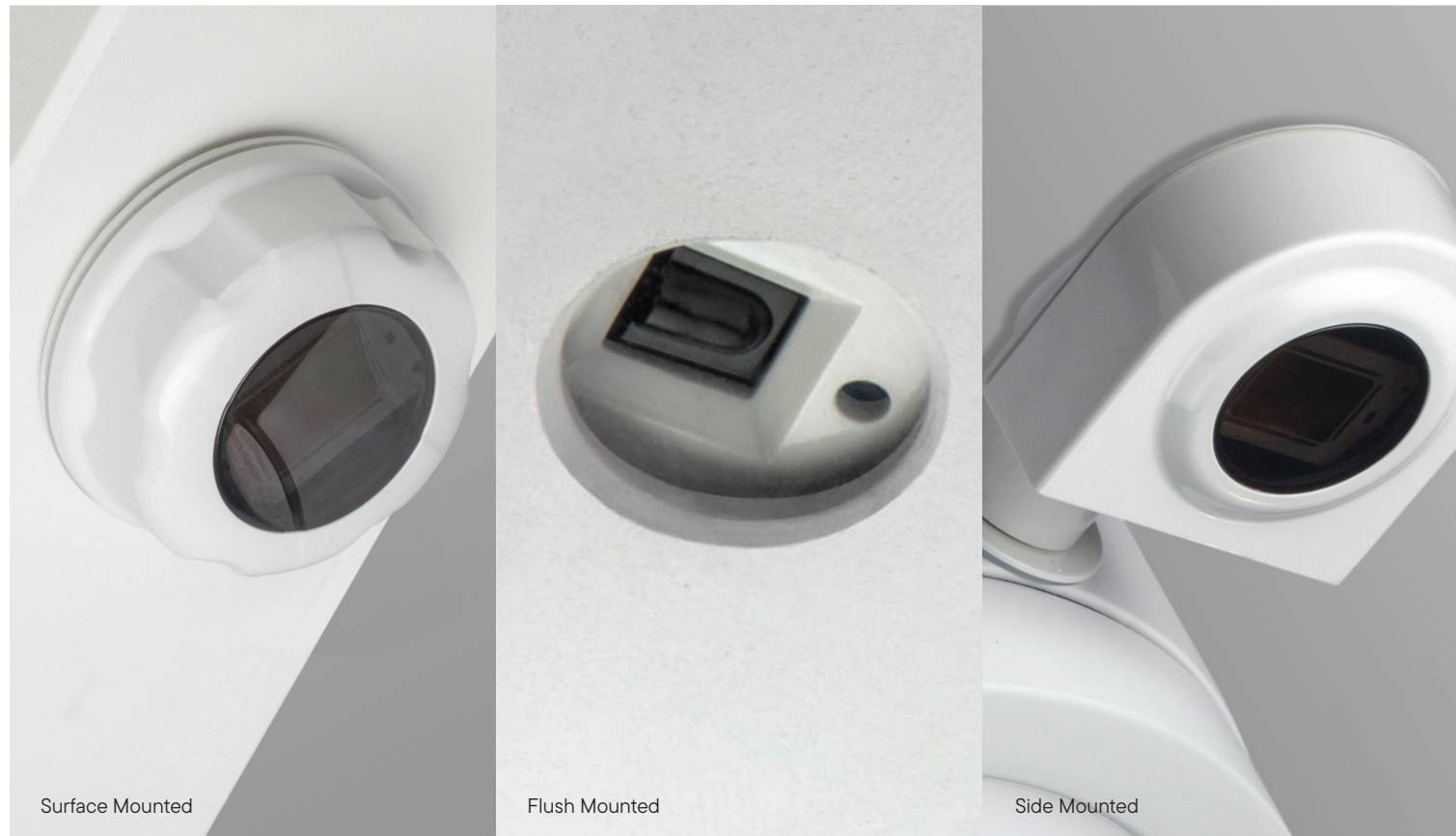

Introducing UniSense™ Technology

UniSense™ technology integrates advanced microwave and PIR (Passive Infrared) sensors with daylight harvesting and dusk/dawn sensing capabilities. It adjusts lighting based on motion, presence, and ambient light levels, automatically dimming or brightening as needed. The system differentiates between natural and artificial light, providing optimized energy efficiency and precise control. It can be controlled via Bluetooth or remote, and is ideal for both indoor and outdoor applications, ensuring seamless and intelligent lighting management in various environments.

PRODUCTS WITH UNISENSE™

Product	SKU	SDL (Integral Daylight)	INT (Integral Motion/Daylight)	RMT (Remote Motion/Daylight)
AG2 SERIES PG. 8-15				
	AGQ2340	•		
	AG2340	•		
	AG2360	•		•
	AG2380	•		•
BOLLARDS/LUMENPOLE PG. 24-37				
	BL7 21/ 22/ 31/ 32		•	
	BL 30/ 31/ 33	•		•
	BL4 31/ 34	•		•
	BL2R-RGBW		•	
	BL2R - 144/ 118/ 98/ 78		•	
	BL2R - 59/ 40/ 31	•		•
	BL2RZ - 144/ 118/ 98/ 78		•	
	BL2RZ - 59/ 40/ 31	•		•
	BL2QZ - 144/ 118/ 98/ 78		•	
	BL2QZ - 59/ 40/ 31	•		•
DL261RP		•		
WD261R		•		
WD-SERIES PG. 38-45				
	WD1340		•	
	WD1360		•	
	WD1Q340		•	
	WD1Q360		•	
	WD1340J	•		•
	WD1360J	•		•
	WD1Q340J	•		•
	WD1Q360J	•		•
	WD1Q362EM		•	
	WD2340	•		•
	WD2360		•	
	WD2Q340	•		•
	WD2Q360		•	
	WD1472/ 1473		•	
	WDQJ340		•	
	WDJ340		•	
WDJ360		•		
SCONCE LIGHTING PG. 46-47				
	WS		•	
DL-SERIES PG. 50				
	DL340		•	
	DL360		•	
	DLQ340		•	
	DLQ360		•	
	DL340J	•		•
	DL360J	•		•
	DLCT340	•		•
	DLCTQ340	•		•
DLCT360	•		•	
DLQ360EM		•		

SENSOR TYPES

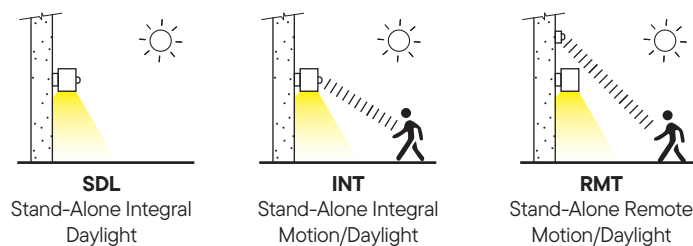

ICONS

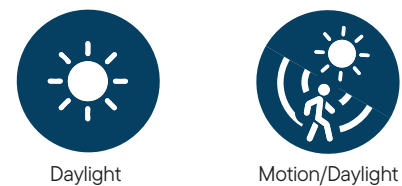

DETECTION COVERAGE

Shown for ceiling mounted fixtures. For other mounting methods, refer to individual product specification pages

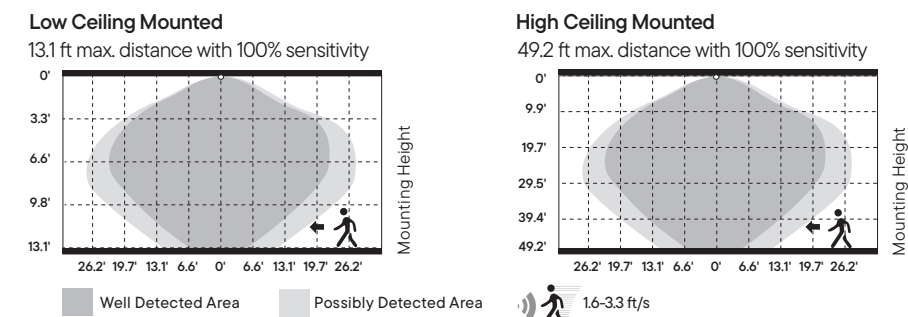

TABLE OF CONTENTS



6 RECESSED FLOOR MOUNT
IG IN-GRADE



8 ABOVE GRADE ACCENT/FLOOD
AG-SERIES



16 FLOOD/SPOT/RGBW
COLORONIX



24 PATHWAY LIGHTING
BOLLARDS
Custom Sizes Available



28 BOLLARDS & COLUMNS
LUMENPOLE



36 WALL & PENDANT
LUMENPOLE



38 WALL MOUNT DIRECTIONAL
WD-SERIES



44 WALL MOUNT ADJUSTABLE
BIONIC

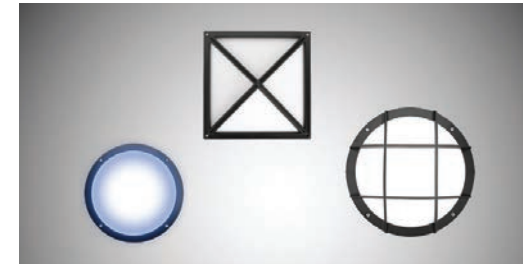

46 WALL MOUNT SCONCE
SURFACE



48 STEP/PATHWAY LIGHTING
RECESSED



50 CEILING MOUNT DOWNLIGHT
DL-SERIES



52 CATENARY MOUNT DOWNLIGHT
DLCT-SERIES

IN-GRADE



Close-up of IG16 In-Grade shown in inset

IG14/IG16 luminaires are ideal for adding drama to the underside of tree canopies

Recessed Floor Mount

In-grade luminaire designed for lighting trees, landscaping, soft ground installation, buildings, and walkways. Easily installs in ground and concrete.

BENEFITS

- High Impact Lens (Drive Over Capable)
- Stainless Steel Ring
- Uniform, Low Glare Illumination
- 5-Year Limited Warranty
- 80+CRI Light Quality
- Singular COB Light Source
- IP65 Rated
- Frosted Lens & Slip Resistant Lens Options



Optional Frosted Lens (-FR) feature diffuses light for less glare.



IG14
300lm (4W)
4-11/16" D



IG16
900lm/1200lm
(10W/12W)
5-15/16" D

IG14/IG16 BEAM SPREADS

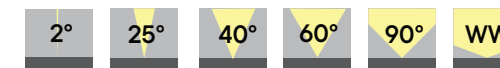

LINK TO WEB PAGE

AG2·SERIES

Advanced outdoor lighting for controlled illumination.

The underside of a tree canopy is illuminated by AG2360 in background



Accent/Spot/Flood

LITON introduces the new AG2-Series, a versatile family of commercial-grade IP65 rated accent, spot, flood lights, to bring sparkle and drama to your outdoor landscape lighting.

The low glare recessed singular COB luminaires include these exciting options:

NEW Variable Beam with field adjustable beam angle from 20° to 50° with clickable pre-set beam options.

RGBW color changing via Wireless Bluetooth or DMX512 for fine-tuned pastel colors and saturated hues.

BENEFITS

- High lumen output up to 16,000LM (160W)
- Variety of mounting methods
- 120-277V/347V Input options
- Optional field adjustable Variable Beam, CCT, and dimming options
- Optional Glare Shield (-SH) to minimize glare



AG2340 shown with optional Glare Shield (-SH)







Two Shapes, Three Sizes

4"	4"	6"	8"
			
AGQ2340 1000lm-1500lm (10W-15W) SDL	AG2340 1000lm-1500lm (10W-15W) SDL	AG2360 1000lm-2600lm (10W-30W) RMT or SDL	AG2380 7500lm-16,000lm (70W-160W) RMT or SDL

 **SDL** (Integral Daylight)
  **RMT** (Remote Motion/Daylight)

STANDARD FINISHES:  White  Silver  Bronze  Black

SPECIAL ORDER FINISHES:  Light Silver  Dark Gray  Metallic Gold  Metallic Black

 Emergency Backup
  US Assembled
  120V
  277V
  347V Option
  Turtle Safe Option

 RGBW Option

 **20°-50°**
VARIABLE BEAM



LINK TO WEB PAGE



The AG2340 provides a dramatic accent to a tree canopy

Accent/Spot/Flood

Lighting applications include:

- Uplight for ambience or directional Viewing
- Downlight for task lighting
- Accent/Spotlight to complement foliage
- Wall Wash to silhouette landscape plantings and foliage



LINK TO WEB PAGE

AG2-SERIES

THE AG2-SERIES ILLUMINATES UP TO 100' AWAY!

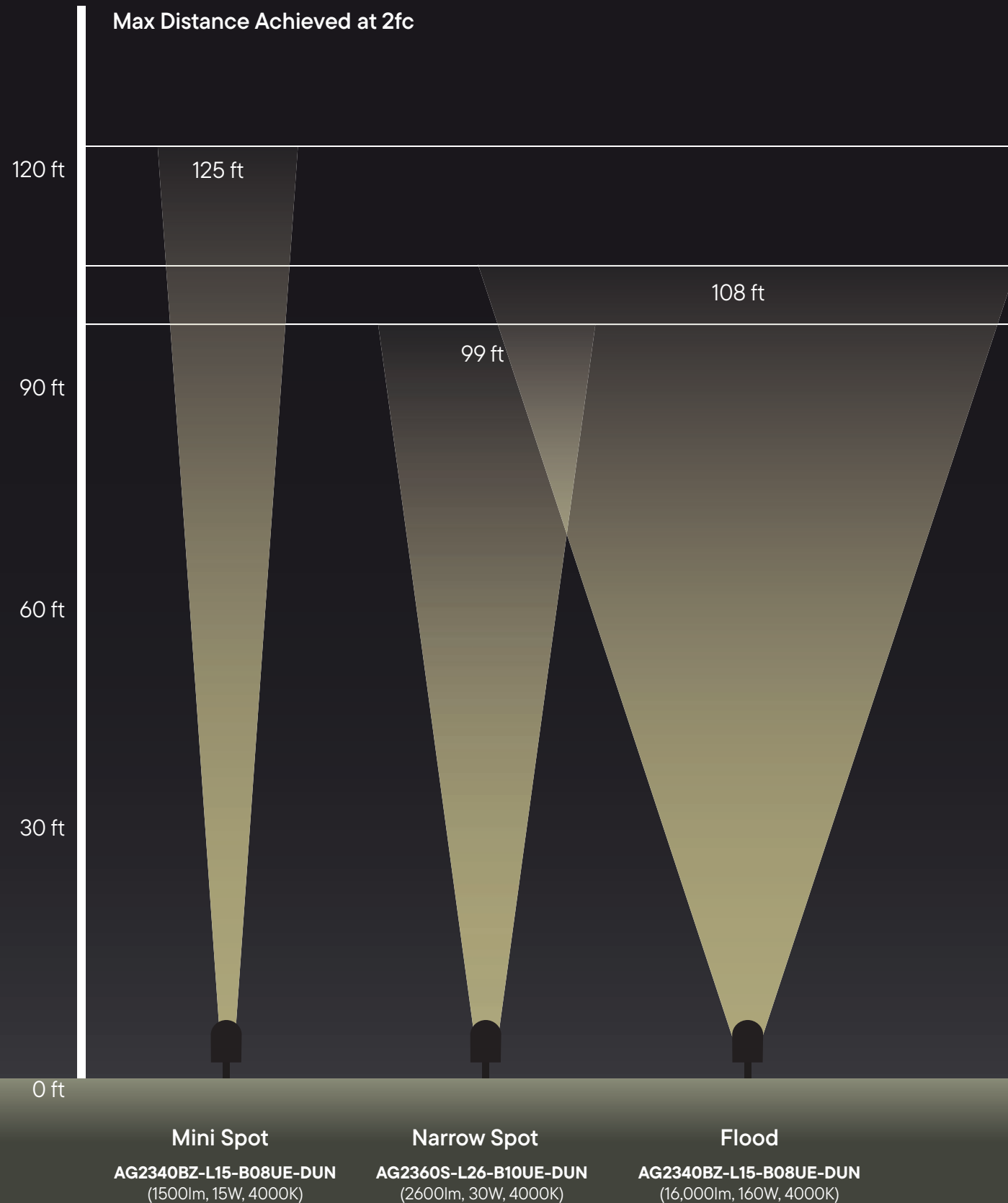

Accent/Spot/Flood - Options



Face Mount Emergency Back Pack Option
Feature is wet location rated and self diagnostic, operating from 120V to 347V with an integral surge protector

RGBW Color Option
Feature allows fine-tuned pastel colors and saturated hues in millions of colors

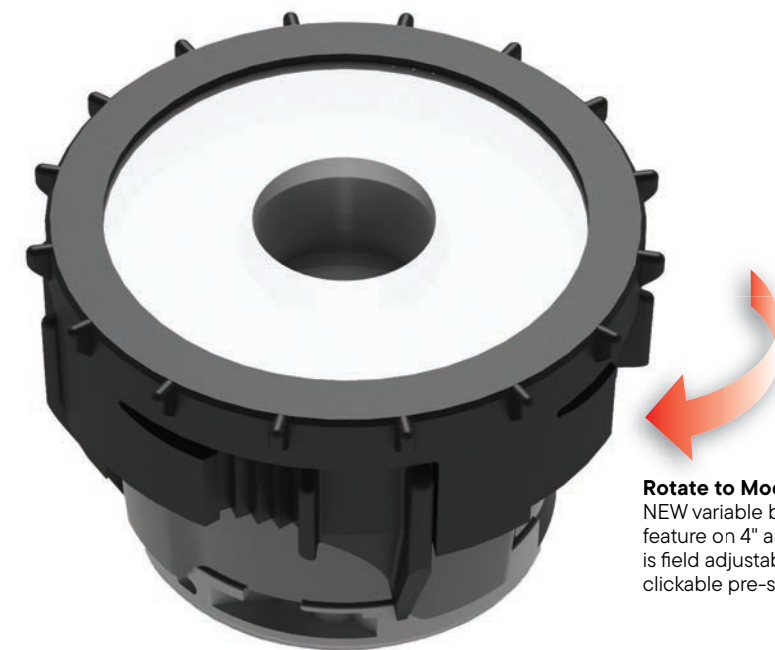

Rotate to Modify Beam Angle
NEW variable beam option is a feature on 4" and 6" models, and it is field adjustable from 20° to 50° with clickable pre-set beam options

STANDARD BEAMS

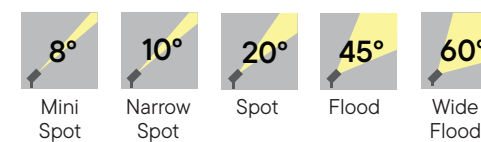

SPECIALTY BEAMS

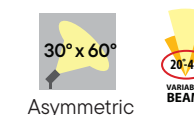

LINK TO WEB PAGE

AG2·SERIES

Suggested Lighting Applications

A) Uplight

Fixtures are aimed away from the viewer and placed behind foliage to avoid glare and maintain a natural looking landscape.

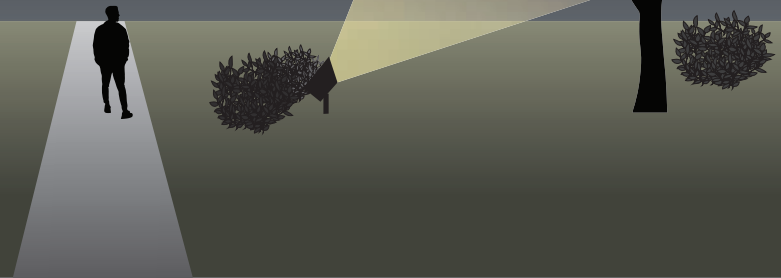

B) Accent/Spotlight

Mount at grade level or overhead to accent details and specify (-SH) Shield to minimize glare.



C) Downlight

For outdoor activity areas, place downlighting above eye level for safety and security. Fixtures can be mounted to building facades or trees.

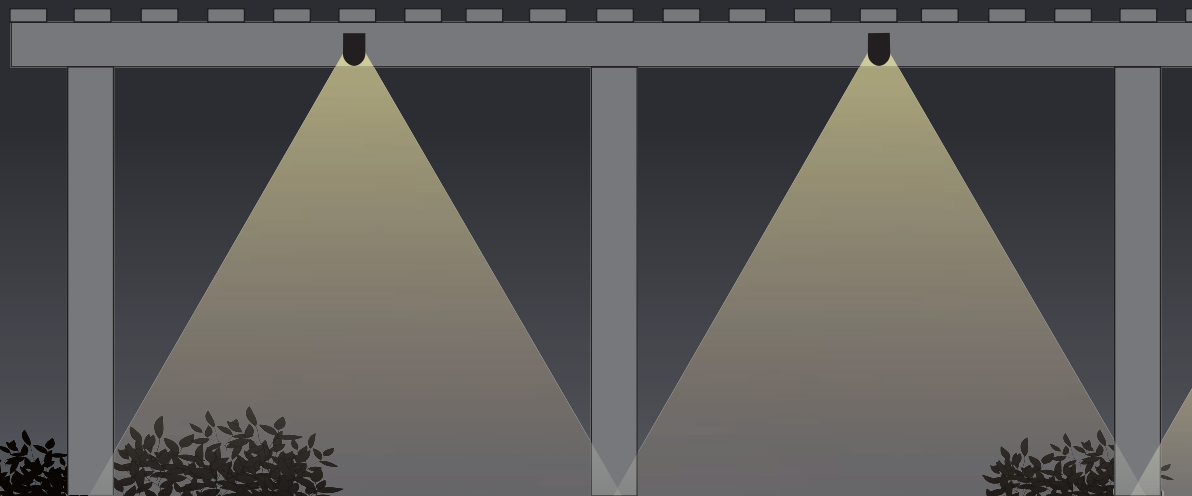

D) Moonlight

A combination of up and downlighting creates the effect of moonlight, bringing a sense of mystery with highlight and shadow accents.



E) Wall Wash/Silhouette

Natural foliage is dramatic when silhouetted against a wall washed with light. Wall Washes provide uniformity when lighting signs and flagpoles.

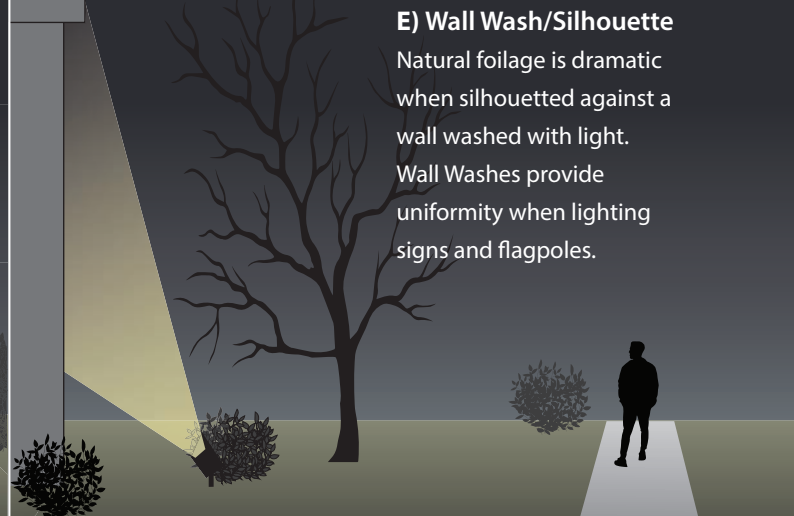

Accent/Spot/Flood - Mounting



AG2340 with Tenon Reducer Hub for mounting two luminaires on a pole

AG2340 with L-Connector and Stem for sign lighting

Mounting Methods/Options

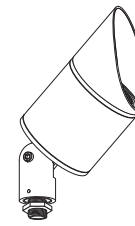

1/2" IPS
Threaded

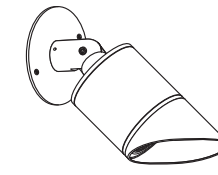
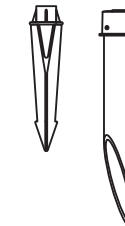
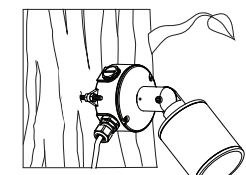

Plate Mount
(-PL)



Stake Mount
/AG2-SPK
/AG2-SPK-AC



Tree Mount
Fixture w/ (-JB)

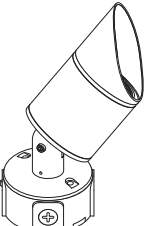

Integral J-Box
(-JB)

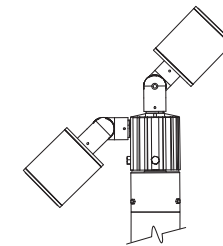

Pole Top Mount
(/AG2-TRH-1/2)

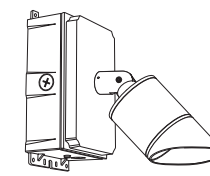

Integral Emergency
Mount (/AG2-EMB)

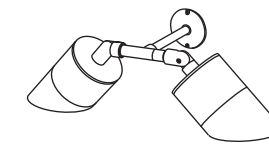

T-Connector
(/AG2-T)

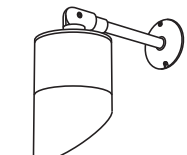

Stem Coupler
(/AG2-CPL)

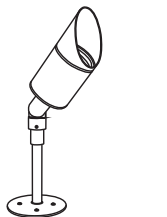

6" Stem Mount
(/AG2-STM06)

Stem Configurations



LINK TO WEB PAGE

Your building is now your canvas.



ColorRay static and dynamic color changing

ColorFlood

Intuitive, easy to use, and with a wide variety of options, the ColorFlood series provides spot and flood LED color changing at the push of a button. Designed for retail, hospitality, high-end residential and a host of other applications, these fixtures come in four output configurations and a wide variety of lensing options.

BENEFITS

- IP66 Available by special order
- Smooth and flicker-free dimming of all colors down to 1%
- Multiple Beam Spreads

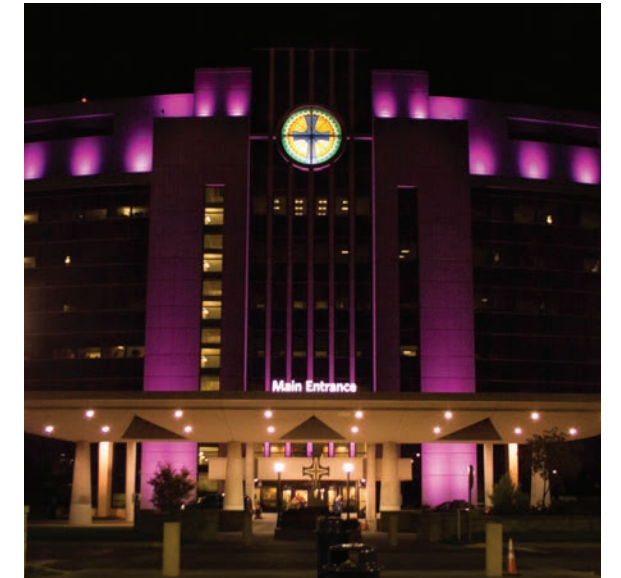

ColorRay static and dynamic color changing

Adjustable Flood/Spot Lighting



SS2-RGBW-8R-04
ColorFlood
4 LED
1100lm (32W)
5-1/2" D



SS2-RGBW-8R-10
ColorFlood
10 LED
2500lm (80W)
8-1/4" D



SS2-RGBW-8R-15
ColorFlood
15 LED
3500lm (110W)
9-1/2" D



SS2-RGBW-120R
ColorFlood
4000lm (120W)
10" D



SS2-RGBW-10S-24
ColorFlood
24 LED
5200lm (161W)
10-3/4" H x 4" W x 15-3/16" L



Internamix
Provides smooth
1-color light output



RGBW
One Red, Green, Blue
and White LED for a
true white



DMX Direct
Four-channel DMX
address for each unit



ColorRay™
Pre-programmed
data-enabled fixtures
come standard



LINK TO WEB PAGE



ColorFacade

Energy efficient, User-Friendly and Stunningly clean optics give these Graze/Wall Wash fixtures a unique place in the market. Designed for use in retail, hospitality, corporate settings and a variety of other markets.

BENEFITS

- DMX direct via LCD display
- Multiple beam spreads
- Proprietary quick connectors included
- Static Colors Available
- InternaMix™ proprietary technology
- Smooth and flicker-free dimming to 1%
- 3-Year Warranty

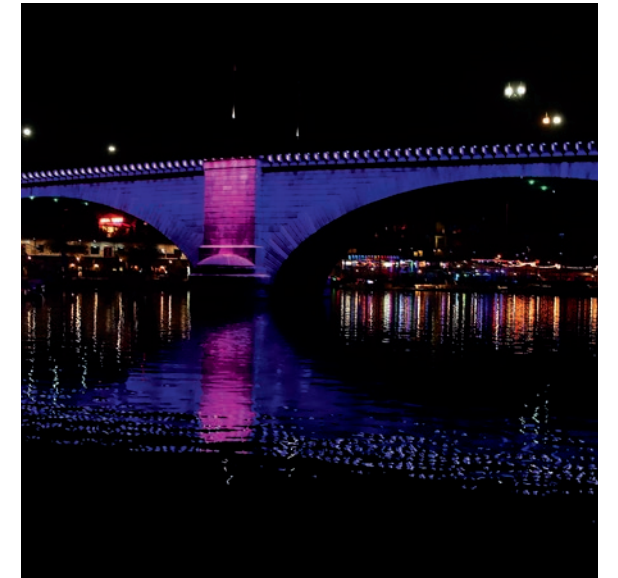

ColorRay static and dynamic color changing

Adjustable Linear Flood/Graze Wall Wash

SS2-5L-16
40" Color Facade
16 LED
3000lm (76W)



SS2-18L-18
40" Color Facade
18 LED
5250lm (105W)



InternaMix

Provides smooth 1-color light output

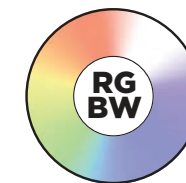

RGBW

One Red, Green, Blue and White LED for a true white



DMX Direct

Four-channel DMX address for each unit



ColorRay™

Pre-programmed data-enabled fixtures come standard



LINK TO WEB PAGE



SS6-RGB-3R and SS6-RGB-6R bring dynamic effects to water features

Underwater & Landscape

Designed to enhance landscape, trees, signage and water features. For smaller projects requiring minimal color changing flood lighting. RGBW design allows fine-tuned pastel colors, saturated hues without sacrificing illumination brightness.

BENEFITS

- DMX direct via data enabler
- Static Colors Available
- InternaMix™ proprietary technology
- Smooth and flicker-free dimming to 1%
- 3-Year Warranty



SS3-RGBW-3R Pathway

Low Voltage



SS6-RGB-3R
3-3/4" Underwater
350lm (15W)



SS6-RGB-6R
5" Underwater
650lm (30W)



SS3-RGBW-3R
5-1/8" Pathway
481lm (15W)



SG3-RGBW-1R
5-1/8" In-Ground
(6W) Low Voltage



InternaMix
Provides smooth
1-color light output

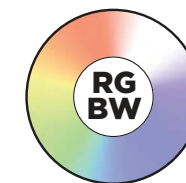

RGBW
One Red, Green, Blue
and White LED for a
true white



DMX Direct
Four-channel DMX
address for each unit



ColorRay™
Pre-programmed
data-enabled fixtures
come standard



LINK TO WEB PAGE



Controls

From simple to complex, Coloronix has a solution to handle your lighting system. All Coloronix products are fully controllable via DMX for those who want to bring their own control solution to the table.



DMX Controllers



SCC5
ColorRay™
Signal Receiver &
Remote Control
12V DC 0.65A

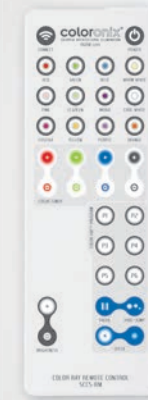

SCC9
Multi-Zone
120VAC



SCC11
Color Control
Touch Zone Controller
5-10V DC 0.6A



Internamix
Provides smooth
1-color light output



RGBW
One Red, Green, Blue
and White LED for a
true white



DMX Direct
Four-channel DMX
address for each unit



ColorRay™
Pre-programmed
data-enabled fixtures
come standard



LINK TO WEB PAGE

BOLLARDS - BL7



B721 bollard shown in inset



BL732 bollard shown in background

Pathway Lighting

LITON 8"x 4" Rectangular Scoop and Trapezoid single and double head bollards are designed for outdoor applications where Dark Sky compliant illumination is required, and they enhance the safety, security, and visual appeal of outdoor spaces.

BENEFITS

- Dark Sky compliant
- Sleek architectural design
- Durable, corrosion resistant finish
- 5-year limited warranty
- 120V/277V UniDim™ 0-10V ELV & Triac dimming to 5%
- Frosted lens option

8" x 4" Rectangular Bollards



BL721 (Scoop)
H: 20", 40"
850lm (15W)
Also available in Amber
INT



BL731 (Trapezoid)
H: 20", 40"
850lm (15W)
Also available in Amber
INT



BL722 (Double Scoop)
H: 20", 40"
2 x 850lm (2 x 15W)
INT

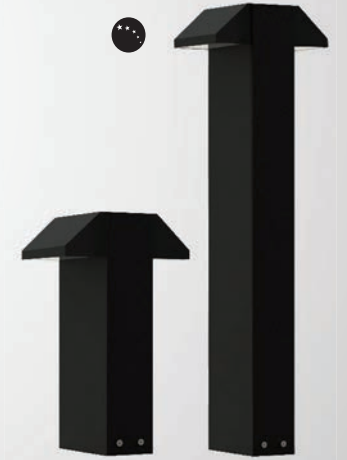

BL732 (Double Trapezoid)
H: 20", 40"
2 x 850lm (2 x 15W)
INT

 **INT** (Integral Motion/Daylight)



Optional Frosted Lens feature

STANDARD FINISHES

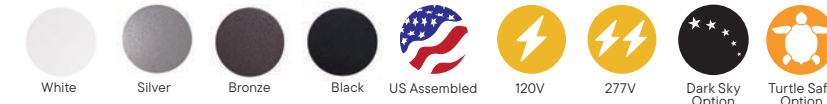

Custom Sizes Available



LINK TO WEB PAGE

BOLLARDS - BL3/BL4

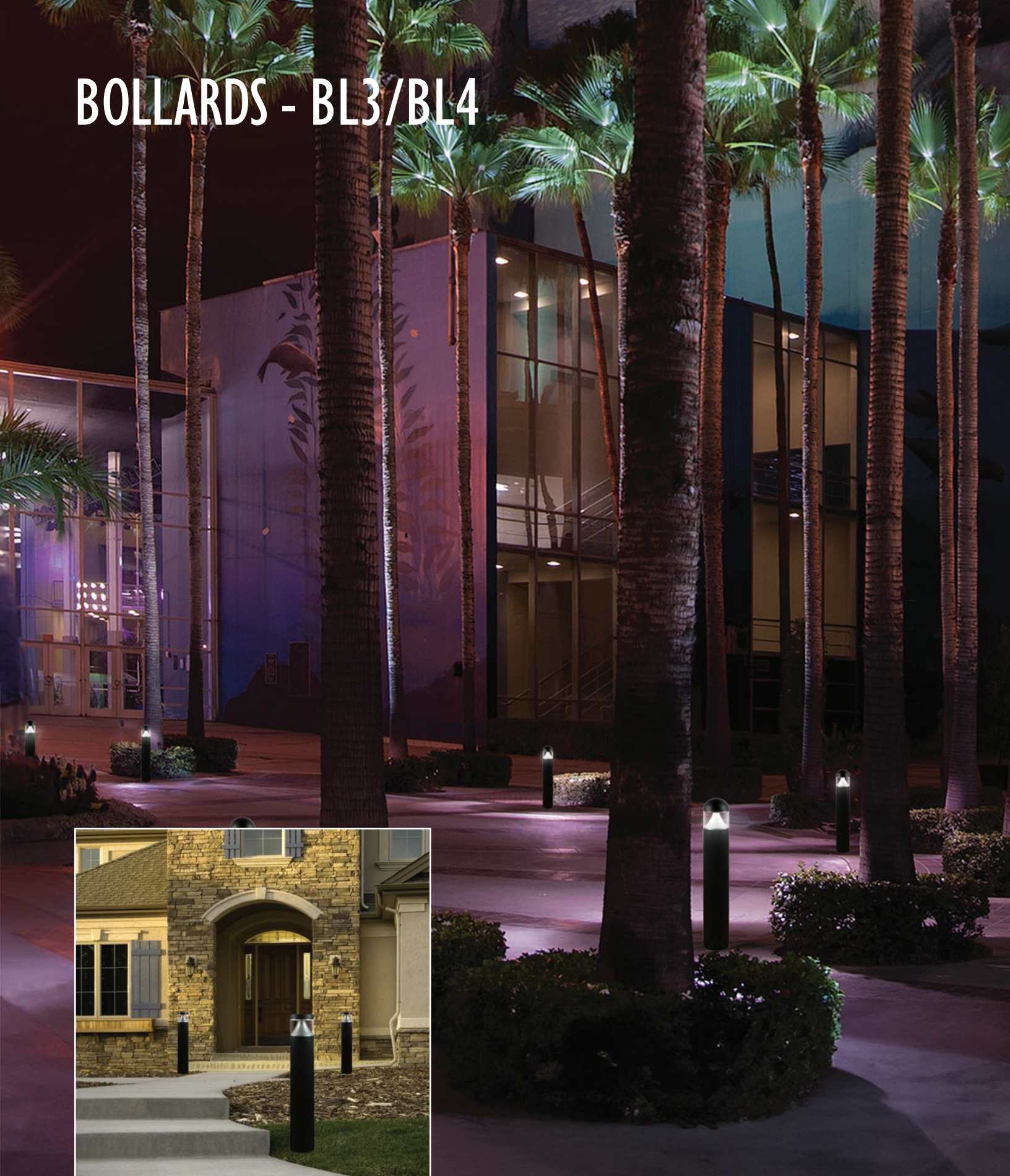

BL31 shown in inset

BL30 Bollards are ideal in courtyards and building entrances

Pathway Lighting

LITON 7" Round bollards are available in various designs and finishes to complement different architectural styles and landscaping themes and to enhance the safety, security, and visual appeal of outdoor spaces.

BENEFITS

- Dark Sky compliant on selected models
- Sleek architectural design
- Durable, corrosion resistant finish
- 5-year limited warranty
- Type IV IES distribution available on BL30 & BL31

7" Round Bollards



BL30
Cone (Round Top)
H: 39-5/16"
2300lm (28W)
RMT or SDL



BL31
Cone (Flat Top)
H: 37-3/16"
2300lm (28W)
RMT or SDL



BL31 Amber Cone
Cone (Flat Top)
H: 37-3/16"
849lm (28W)
RMT or SDL



BL33
Pyramid (Round Top)
H: 38-1/16"
600lm (26W)
RMT or SDL



BL431
(Round Top)
H: 37-1/2"
324lm (15W)
RMT or SDL



BL434
(Flat Top)
H: 38-1/8"
324lm (15W)
RMT or SDL



SDL (Integral Daylight)

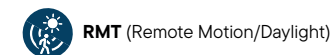

RMT (Remote Motion/Daylight)



Integral or Remote Battery Backup is a feature on selected models

STANDARD FINISHES



Custom Sizes Available



LINK TO WEB PAGE

LUMENPOLE

A consistent look from the parking lot to the lobby.



Available with
Top Mount Spotlight

BL2RZ
Round Open Frame
31" to 144" H
500LM - 2600lm
(8W - 50W)

BL2R
Round Frosted Lens
31" to 144" H
1200lm - 3100lm
(13W - 30W)

BL2QZ
Square Open Frame
31" to 144" H
500LM - 3000lm
(8W - 50W)

Bollards & Columns

LumenPole Bollards and Columns are designed for decorative lighting, way-marking, public areas, driveways, and access roads. Integrating form and function in architecturally relevant sizes, LumenPole effortlessly scales to fit any outdoor space.

By progressively decreasing the height of the luminaire, the fixtures serve as a way finder, pointing the way to the building entrance as pedestrians move closer to a building.

BENEFITS

- 6" Round Frosted Lens or Open Frame
- 6" Square Open Frame
- From 31" to 144" H
- Up to 3100lm (50W) delivered
- Dark Sky compliant
- Tamper resistant hardware
- IK08 impact rating
- RGBW, photocell & integral emergency options
- Full IES files available

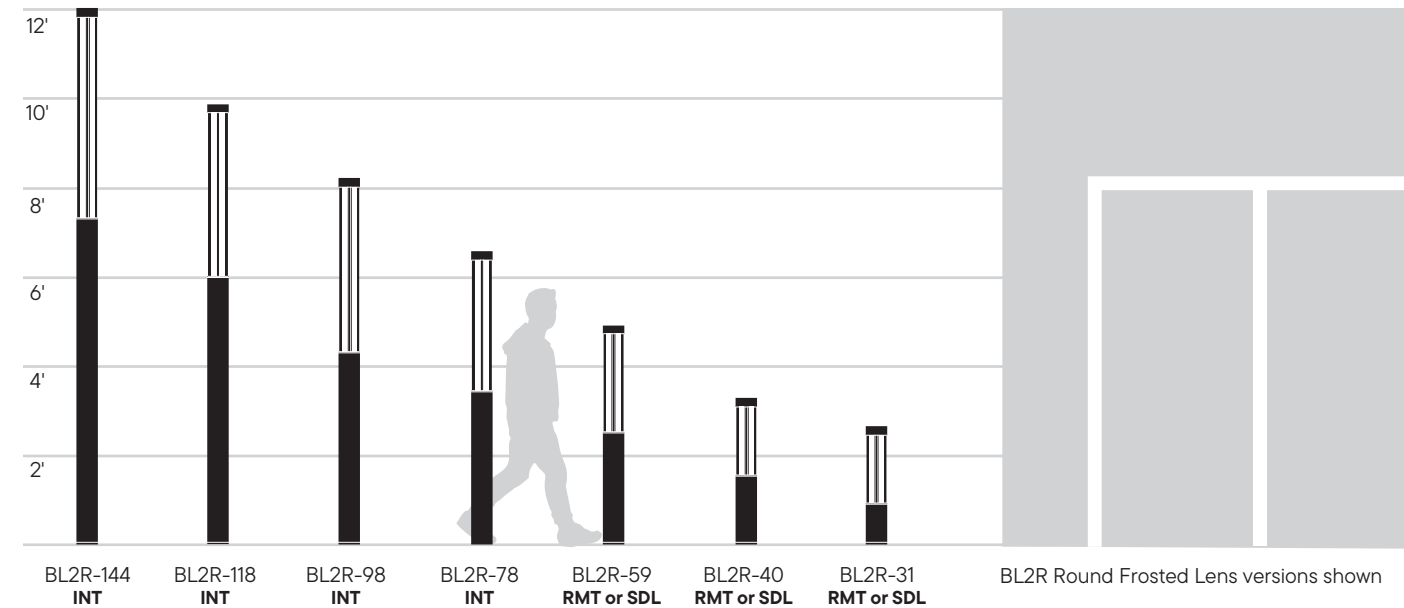

- SDL** (Integral Daylight)
- RMT** (Remote Motion/Daylight)
- INT** (Integral Motion/Daylight)

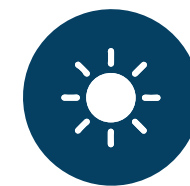

Daylight



Motion/Daylight

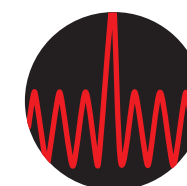

Surge Protector feature to protect and enhance longevity



Integral Battery feature for illumination during power outages

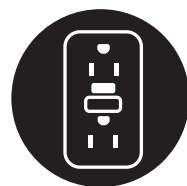

GFCI & In-Use Cover feature to minimize risk and ensure the reliability



LINK TO WEB PAGE

LUMENPOLE

ROUND FROSTED LENS



BL2R-78 RGBW shown in inset

Round Frosted Lens

LumenPole Round Frosted Lens Bollards and Columns feature an opal acrylic lens to provide uniform light distribution for consistent brightness and reduced glare and harsh shadows throughout the illuminated area.

BENEFITS

- 6" Round from 31" to 144" H
- Up to 3100lm (30W) delivered
- Tamper resistant hardware
- IK08 impact rating
- RGBW, photocell & integral emergency options
- Full IES files available

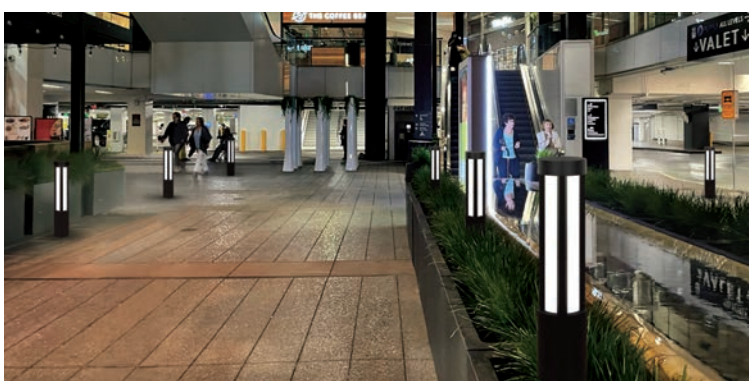

BL2R Round Frosted Lens shown in outdoor and retail food court settings

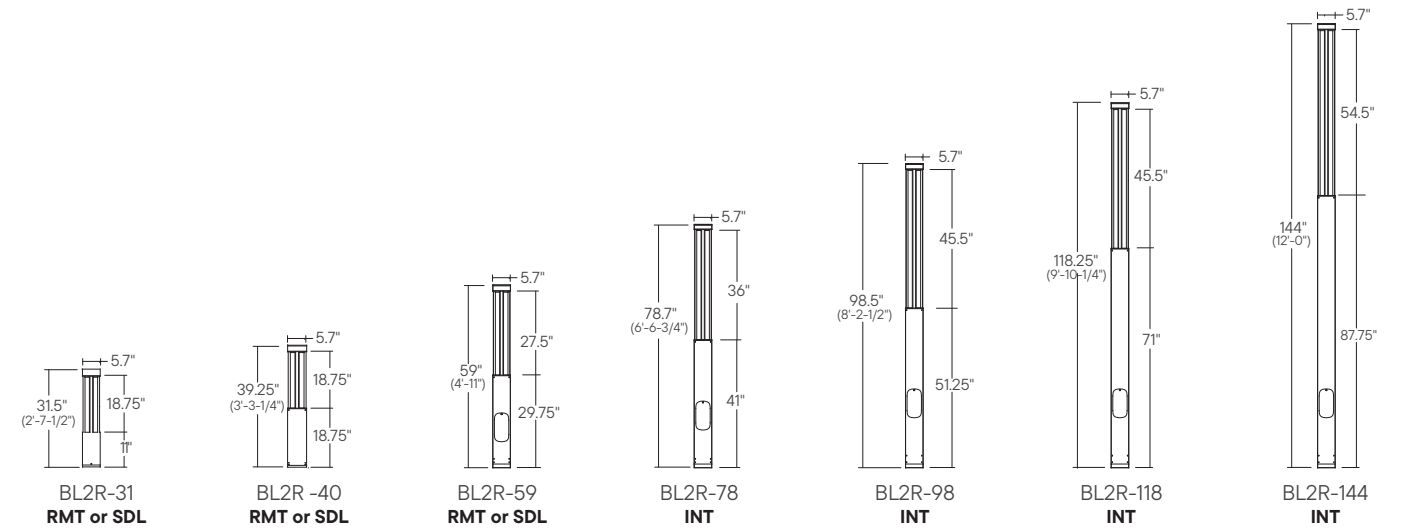

- SDL** (Integral Daylight)
- RMT** (Remote Motion/Daylight)
- INT** (Integral Motion/Daylight)

STANDARD FINISHES

- White
- Silver
- Bronze
- Black

RGBW Option
 US Assembled
 120V
 277V
 347V Option
 IK08



LINK TO WEB PAGE

LUMENPOLE

ROUND OPEN FRAME



BL2RZ-98 shown in inset and background

Round Open Frame

LumenPole Round Open Frame Bollards and Columns feature a smooth, cylindrical shape to provide even illumination in all directions enhancing visibility and safety. The COB LED with reflector provides illumination downward on the ground to light walkways, and other public and private gathering spaces.

BENEFITS

- 6" Round from 31" to 144" H
- Up to 2600lm (50W) delivered
- Dark Sky compliant
- Tamper resistant hardware
- IK08 impact rating
- Photocell & integral emergency options
- Full IES files available



BL2RZ Round Open Frame shown outdoors and adjacent to a parking garage

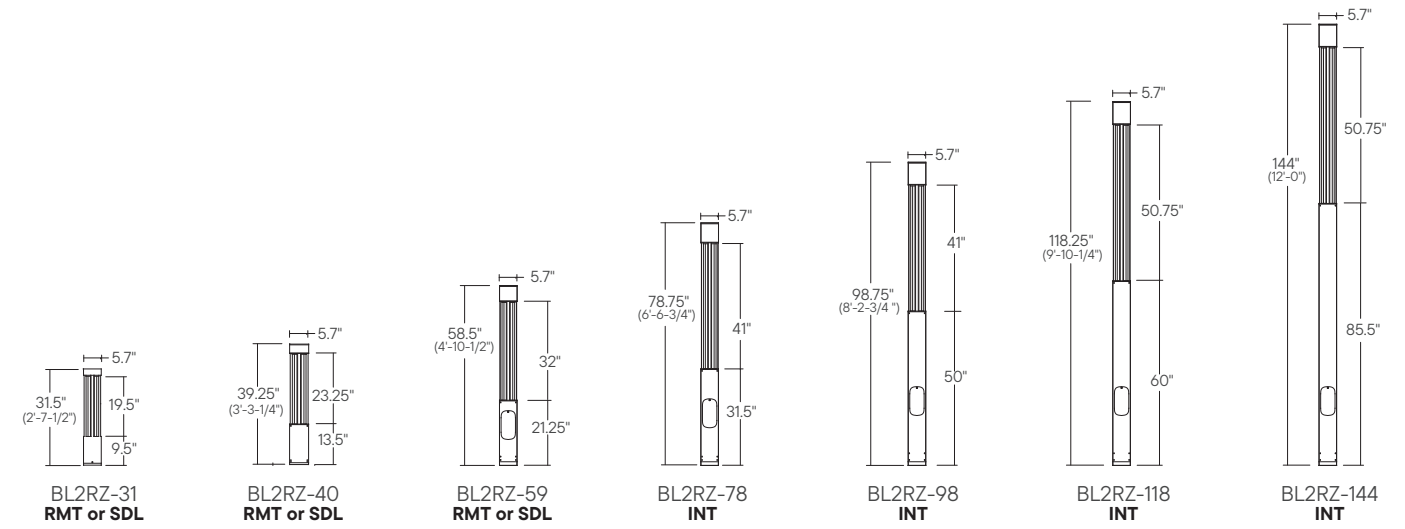

- SDL** (Integral Daylight)
- RMT** (Remote Motion/Daylight)
- INT** (Integral Motion/Daylight)

- STANDARD FINISHES
- White
 - Silver
 - Bronze
 - Black

- Emergency Backup
- US Assembled
- 120V
- 277V
- 347V Option
- Dark Sky Option
- Turtle Safe Option
- IK08



LINK TO WEB PAGE

LUMENPOLE

SQUARE OPEN FRAME



BL2QZ-31 shown in inset

BL2QZ-59 and BL2QZ-144 shown in background

Square Open Frame

LumenPole Square Open Frame Bollards and columns feature clean, angular lines for spaces that require stronger architectural presence and a more defined light pattern. The COB LED with reflector provides illumination downward on the ground to light walkways, and other public and private gathering spaces.

BENEFITS

- 6" Square from 31" to 144" H
- Up to 2600lm (50W) delivered
- Dark Sky compliant
- Tamper resistant hardware
- IK08 impact rating
- Photocell & integral emergency options
- Full IES files available



BL2RZ Square Open Frame



40", 59", 78", 98", 118" & 144" Bollards & Columns feature easy, yet secure tamper resistant access through side-entry electrical panel

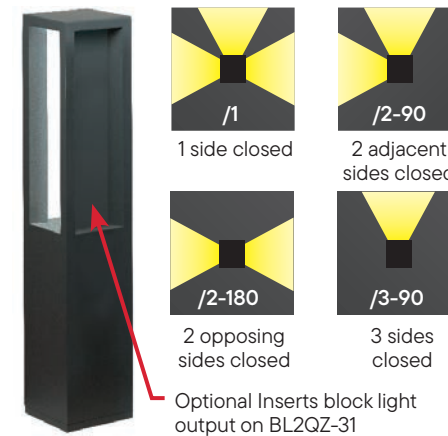

Optional Frosted Lens feature for BL2QZ 40" to 144"



Optional DMX 512 Remote Mounted Decoder feature for BL2QZ-RGBW

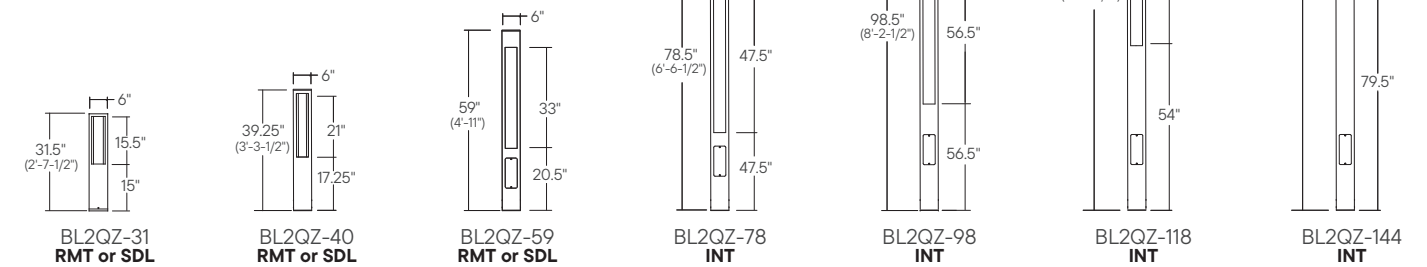

- SDL** (Integral Daylight)
- RMT** (Remote Motion/Daylight)
- INT** (Integral Motion/Daylight)



LINK TO WEB PAGE

LUMENPOLE

ROUND FROSTED LENS
WALL & PENDANT

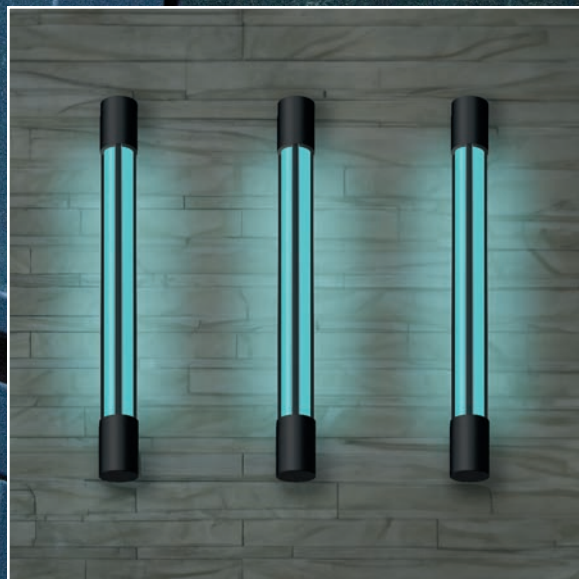

WD261R with RGBW feature is shown highlighting a building entrance

Round Frosted Lens Wall & Pendant

LumenPole Wall and Pendant Frosted Lens versions extend the product line all the way into the building. Wall mount versions can be mounted up or down. RGBW color changing is also available.

BENEFITS

- 6" Round
- 1200lm-7300lm (13W-85W)
- Wall mount available with uplight & downlight
- Pendant available with downlight
- IK08 Impact Rating
- RGBW, and Photocell, options
- 12", 24" & 36" Pendant stem heights
- 5-year warranty
- Standard UniDim™ for all except (-RGBW)

Pendant Stem Mounts



DL261RP-19
19" Frosted Lens
Downlight/no Downlight
1200lm-3800lm
(13W-43W)
INT



DL261RP-28
28" Frosted Lens
Downlight/no Downlight
1700lm-4300lm
(20W-50W)
INT



DL261RP-36
36" Frosted Lens
Downlight/no Downlight
2100lm-4700lm
(25W-50W)
INT

Downlight Options

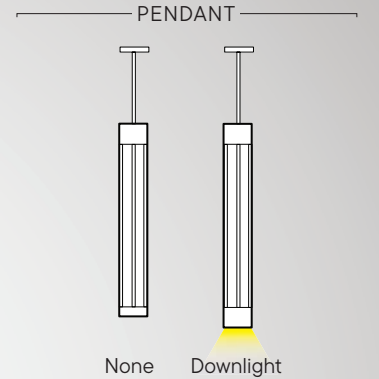

Wall Mount



WD261R-19
19" Frosted Lens
Single Arm
Uplight/Downlight
1200lm-4100lm
(13W-48W)
INT



WD261R-28
28" Frosted Lens
Double Arm
Uplight/Downlight
1700lm-6900lm
(20W-80W)
INT



WD261R-36
36" Frosted Lens
Double Arm
Uplight/Downlight
2100lm-7300lm
(25W-85W)
INT

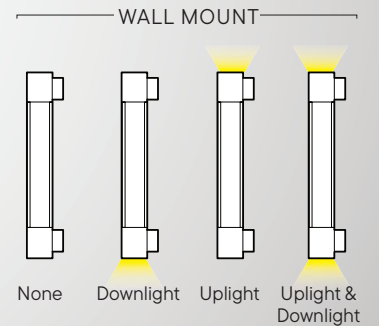

 INT (Integral Motion/Daylight)

STANDARD FINISHES

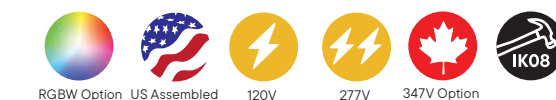

Optional Glare Shield feature



PENDANT WEB PAGE



WALL MNT. WEB PAGE

WD-SERIES

Versatile luminaires for precise directional lighting.

WD1360J Adjustable shown in background



WD1360 Downlight shown in inset

Wall Mount Directional

LITON's WD-Series 1-direction wall luminaire can be pointed up or down and used as downlight for direct illumination or uplight for indirect illumination of architecture facades.

BENEFITS

- Energy efficient, low glare LED Chip-On-Board light engine
- 1-Direction is available with Standard, Cleanbeam™ or Specialty beams
- 1-Direction Adjustable is available with 45° Flood or 60° Wide Flood
- 5-Year Limited Warranty
- Integral Emergency Option!

1-Direction Downlight



WD1340
4" Round
1000lm-1500lm
(15W-22W)
INT



WD1360
6" Round
1000lm -2600lm
(15W-30W)
INT



WD1Q340
4" Square
850lm (15W)
INT



WD1Q360
6" Square
1000lm -2600lm
(15W-30W)
INT

1-Direction Adjustable



WD1340J
4" Round Adjustable
700lm (9W)
RMT or SDL



WD1360J
6" Round Adjustable
1500lm (15W)
RMT or SDL



WD1Q340J
4" Square Adjustable
700lm (9W)
RMT or SDL



WD1Q360J
6" Square Adjustable
1500lm (15W)
RMT or SDL



SDL (Integral Daylight)



RMT (Remote Motion/Daylight)



INT (Integral Motion/Daylight)

4" & 6" DOWNLIGHT

STANDARD BEAMS				CLEANBEAM™			SPECIALTY BEAMS		

ADJUSTABLE DOWNLIGHT

4" STANDARD BEAMS			6" STANDARD BEAMS			

STANDARD FINISHES				SPECIAL ORDER FINISHES			
White	Silver	Bronze	Black	Light Silver	Dark Gray	Metallic Gold	Metallic Black
RGBW Option	Emergency Backup	US Assembled	120V	277V	347V Option	Dark Sky Option	Turtle Safe Option

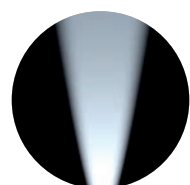

CleanBeam feature for uniform light output



LINK TO WEB PAGE

WD-SERIES



WD2360 with Integral Emergency Back Pack (-EMB-SD) feature shown in inset

WD2360 with RGBW option shown in background

Wall Mount Bi-Directional

LITON's 2-direction wall luminaire's dual reflector design allows for direct and indirect lighting from a single fixture. Typical locations are in commercial and retail spaces that contain walls and/or columns that require directional lighting.

BENEFITS

- Energy efficient, low glare LED Chip-On-Board light engine
- Standard, Cleanbeam™ or Specialty beam options
- Integral & remote Emergency options available
- 5-Year Limited Warranty

2-Direction Up/Down



WD2340
4" Round
2 x 1000lm (30W)
RMT or SDL



WD2360
6" Round
2 x 1000lm-2600lm
(30W-64W)
INT



WD2Q340
4" Square
2 x 850lm (30W)
RMT or SDL



WD2Q360
6" Square
2 x 1000lm -2600lm
(30W-64W)
INT

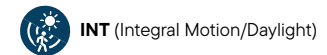
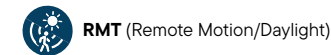

Options



CleanBeam feature for uniform light output



Direct Conduit J-Box entry feature for in-line installation

STANDARD BEAMS

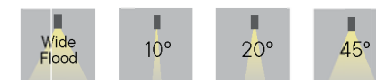

CLEANBEAM™

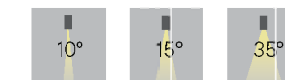

SPECIALTY BEAMS

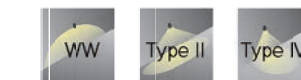

STANDARD FINISHES				SPECIAL ORDER FINISHES			
White	Silver	Bronze	Black	Light Silver	Dark Gray	Metallic Gold	Metallic Black
RGBW Option	Emergency Backup	US Assembled	120V	277V	347V Option	Dark Sky Option	Turtle Safe Option



LINK TO WEB PAGE

WD-SERIES



WD1473 Trapezoid shown in background

WD1472 Scoop shown in inset

Wall Mount Scoop/Trapezoid

The Scoop/Trapezoid single reflector design can be used for direct illumination downward or indirect illumination upward. The fixtures are dark sky compliant, and also available in an optional Florida Fish and Wildlife Turtle Safe approved version.

BENEFITS

- Sleek architectural design
- Durable, corrosion-resistant finish
- Emergency back up available
- 5-year limited warranty
- Now with Integral Emergency Option!

Scoop/Trapezoid



WD1472 8" (Scoop)
8" x 4" Rectangle
850lm (15W)
INT



WD1473 (Trapezoid)
8" x 4" Rectangle
850lm (15W)
INT

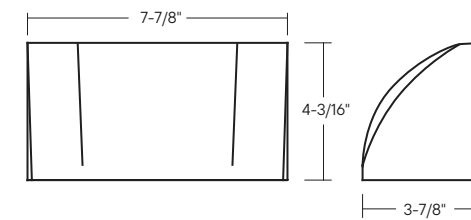
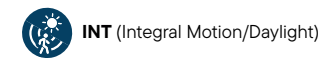

WD1472

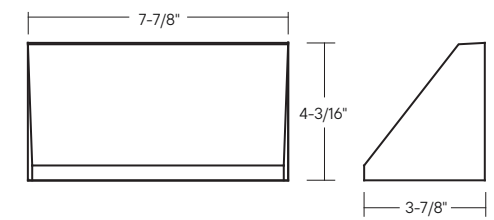

WD1473

STANDARD BEAMS

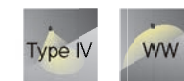

STANDARD FINISHES				SPECIAL ORDER FINISHES			
White	Silver	Bronze	Black	Light Silver	Dark Gray	Metallic Gold	Metallic Black
RGBW Option	Emergency Backup	US Assembled	120V	277V	347V Option	Dark Sky Option	Turtle Safe Option
		ADA Compliant					



LINK TO WEB PAGE

BIONIC



WDJ340 with Integral Emergency Back Pack (-EMB-SD) feature shown in inset

Wall Mount Bi-Directional

LITON's New Bionic bi-directional luminaire combines a wall mounted downlight with a spotlight to create a dynamic, visually striking outdoor environment. It can be mounted in an up or down configuration for additional versatility.

BENEFITS

- 120-277V Input options
- Glare Shields for eye comfort
- Multiple Beam Spreads & Color Temperatures
- Integral J-box option
- Emergency Back-Pack option
- Available with Type IV/Forward Throw

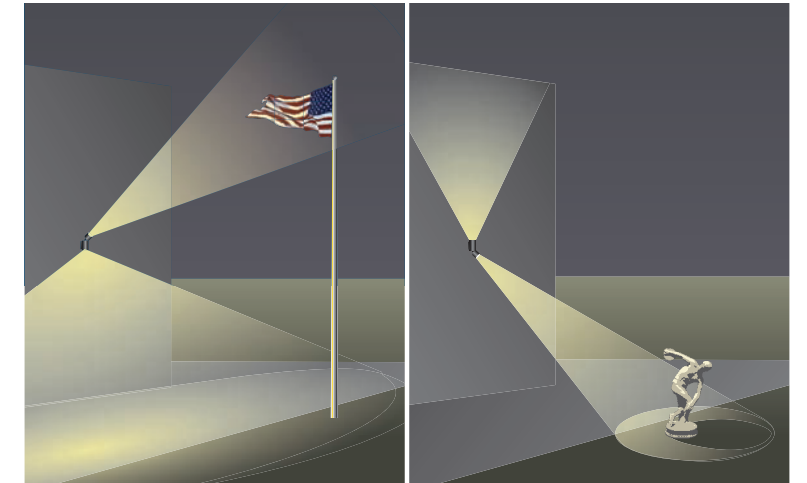

Downlight & Spotlight

Uplight & Spotlight



WDQJ340
4" Square
2 x 1000lm/1500lm
(20W/30W)
INT



WDJ340
4" Round
2 x 1000lm/1500lm
(20W/30W)
INT



WDJ360
6" Round
2 x 1000lm - 2600lm
(20W to 60W)
INT

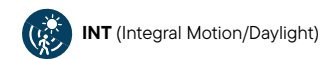

STANDARD FINISHES				SPECIAL ORDER FINISHES			
White	Silver	Bronze	Black	Light Silver	Dark Gray	Metallic Gold	Metallic Black
RGBW Option	Emergency Backup	US Assembled	120V	277V	347V Option	Tamper Resistant	



LINK TO WEB PAGE

WALL/CEILING

WS700C Open Face shown in background

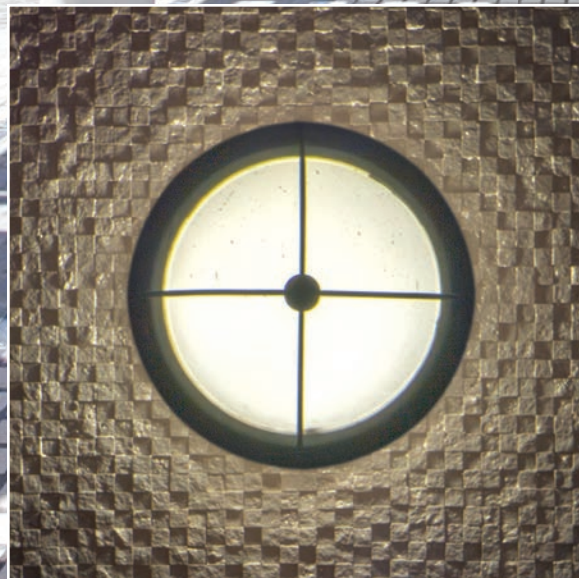

WS730C Bulls-Eye shown in inset

Sconce Lighting

Surface, ceiling or wall mount Sconce
Luminaires are ideal for indoor or outdoor applications that require the fixture to integrate into the design of the structure.

BENEFITS

- Impact Resistant
- Diffusing Lens.
- Tamper Proof Hardware
- 80+CRI Light Quality
- ADA Compliant
- IP65 Rated
- RGBW Option

WS7-Series 10" Round

600lm-1500lm (10W/15W) except where noted

 INT (Integral Motion/Daylight available for all WS products)



WS730C
Bulls-Eye



WS730C
Decorative Cross Bar



WS733S
Guard Bar



WS750S
Half Lid



WSQ234S
11" Square
500LM (13W)



WS770S
Vanguard

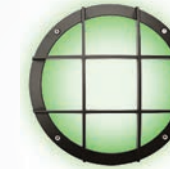

WS734C
Cross Bar



WS700C
Open Face

WS8-Series 14" Round

600lm-1500lm (10W/15W) except where noted



WS800
Open Face



WS804
Vertical & Horizontal



WS830
Cross Bar



WS833
Guard Bars

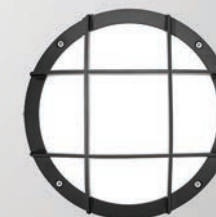

WS834
Cross Bars

STANDARD FINISHES



White Silver Bronze Black



RGBW Option



Emergency Backup



US Assembled



120V



277V



ADA Compliant



Tamper Resistant



LINK TO WEB PAGE

STEP/PATHWAY

12" Flat Recessed (SL120) shown in background



Open Lens Vertical (LSLD00) shown in inset.

Recessed Wall Mount

Die-cast Wall Luminaires for low mounting heights on steps, walkways, and other indoor and outdoor applications.

BENEFITS

- No remote driver required
- ELV Dimmable
- Die-cast
- 5-year warranty
- ADA compliant

2.5" Square or Round & 2" x 3" Rectangle



LSLDQ00
Open Lens Square
240lm (3.5W)



LSLDQ73
Square Louver
240lm (3.5W)



LSLDR00
Open Lens Round
240lm (3.5W)



LSLDR73
Round
Glare-Free Louver
240lm (3.5W)



LSLD00
Open Lens Vertical
44.5lm (2.7W)



LSLDH00
Open Lens Horizontal
240lm (3.5W)
Also available in Amber



LSLD73
Vertical
Rectangular Baffle
240lm (3.5W)
Also available in Amber



LSLDH73
Horizontal
Rectangular Baffle
240lm (3.5W)
Also available in Amber

7" to 12" Recessed



SL120
12" Flat Recessed
150lm (5W)



SL600
9" Open Face
800lm (9W)



SL632
9" Angled Louver
300lm (9W)



SL630
9" Louver Face
600lm (9W)
Also available in Amber



SL650
9" Half Lid Faceplate
800lm (9W)



SL700
11" Open Face
1000lm/1500lm
(11W/20W)



SL400
7" Stainless Steel
250lm (8W)



SL762
11" Vertical Louver Face
1000lm/1500lm
(11W/20W)

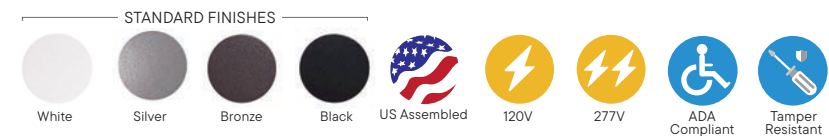

LINK TO WEB PAGE

DL-SERIES

Versatile luminaires for precise directional lighting.

DL340 Downlight shown in background



DLQ360EM integral emergency shown in inset

Ceiling Mount

LITON's DL Series ceiling mount downlight can be used in both outdoor and indoor settings. Typical locations are in commercial and retail spaces that require lighting from above. Pendant kits are also available in 12", 18", 24", 36", and 48" lengths.

BENEFITS

- 4" & 6" Round & Square
- Energy efficient, low glare LED Chip-On-Board light engine
- DL-Series is available with Standard, Cleanbeam™, or Specialty beam options
- Integral Surface J-Box option
- 5-Year Limited Warranty
- Integral Emergency option!

4" & 6" Downlight



DL340
4" Round
1000lm-1500lm
(10W-15W)
INT



DL360
6" Round
1100lm-2600lm
(10W-30W)
INT



DLQ340
4" Square
1000lm-1500lm
(10W-15W)
INT



DLQ360
6" Square
1100lm-2600lm
(10W-30W)
INT

4" & 6" Adjustable Downlight



DL340J
4" Round Adjustable
700lm (9W)
RMT or SDL



DL360J
6" Round Adjustable
700lm (10W)
RMT or SDL

- SDL** (Integral Daylight)
- RMT** (Remote Motion/Daylight)
- INT** (Integral Motion/Daylight)

Options



CleanBeam feature for uniform light output



Pendant kit feature (LCMPDL/LCMPDLQ) 12"- 48"L for flat and sloped ceilings

STANDARD BEAMS

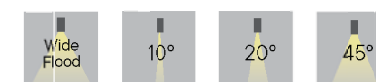

CLEANBEAM™

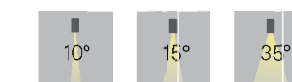

SPECIALTY BEAMS



STANDARD FINISHES



SPECIAL ORDER FINISHES



- RGBW Option
- Cold Weather
- Emergency Backup
- US Assembled
- Wet
- Downlight
- Wall Wash
- Intertek
- 120V
- 277V
- 347V Option
- Dark Sky Option
- Turtle Safe Option



LINK TO WEB PAGE

DLCT-SERIES

DLC34-PD Pendants and DLC34-AJ Adjustable Downlight with Glare Shield (-SH) shown in background



Wall Mount Emergency System (-EMB) feature

Catenary Downlight

Designed for outdoor settings that need direct control of light, LITON's Catenary Mounting System supports the installation of DL luminaires and their required wiring on a catenary cable. Catenary cables, fittings and other structural elements provided by others.

BENEFITS

- 1000lm-2600lm (10W-30W)
- Direct (DM), Pendant (PD), Adjustable (AJ) or 6"- 36" Stem (ST)
- 3 and 5 Conductor Power Cord ordered separately
- Emergency & RGBW options

Available Luminaires



DLCT340-AJ
4" Round Adjustable
1000lm-1500lm
(10W-15W)
RMT or SDL

DLCTQ340-PD
4" Square Pendant
1000lm-1500lm
(10W-15W)
RMT or SDL

DLCT360-DM
6" Round Direct
1000lm-2600lm
(10W-30W)
RMT or SDL



SDL (Integral Daylight)



RMT (Remote Motion/Daylight)

Options



Optional Frosted Lens feature



Optional Hex-Cell Louver feature



Optional Glare Shield feature

STANDARD BEAMS

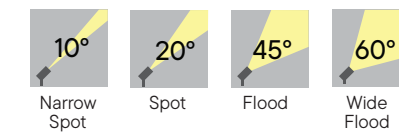

SPECIALTY BEAMS

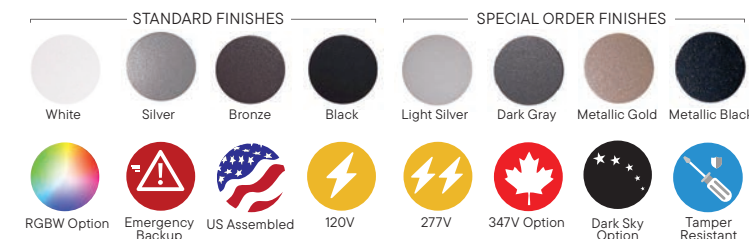
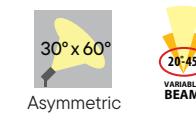

LINK TO WEB PAGE