

LITON®

Indoor Lighting  
Solutions

LITON®

# INTRODUCTION

## LITON's Indoor Lighting Collections: Innovative, Versatile, and Designed for Excellence.

LITON's indoor lighting collections are designed to meet the highest standards of functionality, style, and performance. From architectural spaces to commercial and residential settings, our products offer innovative solutions tailored to diverse lighting needs. With a focus on design consistency and advanced engineering, our indoor collections bring together form and function to elevate your interiors. Explore our comprehensive range of products, including recessed, track, and pendant lighting solutions, each crafted to deliver exceptional illumination with precision and reliability. Whether you're enhancing workspaces, creating ambiance, or highlighting architectural details, LITON has the perfect solution to illuminate your vision.

# INDOOR GRADES

## SPECIFICATION GRADE

## ARCHITECTURAL GRADE

## ESSENTIAL GRADE

### LUMINAIRE TYPE

- Super Low Glare UGR with Maximum Lumen Output
- Dedicated LED for Tight Binning Control
- High CBCP

- Moderate Low Glare UGR
- Variety of Beam & Control Options
- ColorSelect

- Basic Glare Control
- Many Ready2Ship Items

### 1" TO 3.5" RECESSED



PRECISION P-SERIES 6



P-SERIES MATRIX 10



MINIATURE MINI-ARC 16

### 4" | 6" | 8" RECESSED



HIGH CBCP LUMENBLAST 12



ARCHITECTURAL DOWNLIGHT C-SERIES 14



DMX RGBW DOWNLIGHT COLORONIX 26

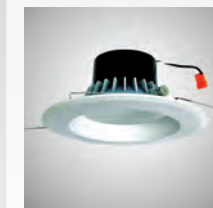

GENERAL PURPOSE E-SERIES 45

### SURFACE



PRECISION P-SERIES 8



HIGH LUMEN LUMECANNON 18



ADJUSTABLE ACCENT CYLOPRO 24



COMPACT ACCENT CYLO 20



DMX RGBW COLORONIX 28

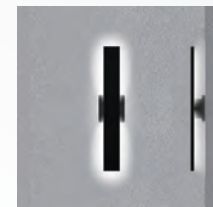

DARKLIGHT INDIREKT 30



SLIM EDGE LIT LUMENPAD 32



GENERAL PURPOSE LUMEN DISC 40

### TRACK LIGHTING



ADJUSTABLE ACCENT CYLOPRO 24



HIGH CBCP APOLLO 34



COMPACT ACCENT CYLO 22



DECORATIVE SATURN 35



GU10's LT5 42



PAR's LT8 42

### LINEAR



MODULED STEALTH 36



MINIATURE LINEAR DALUME 38



TILT PRO LINKABLE DALUME LINEO 44



LINEAR ACCENT LED PROSTICK 44

# LITON CONTROL INTEGRATIONS



Casambi enables wireless Bluetooth Mesh control of LITON luminaires without the need for additional wiring or gateways. Ideal for scalable commercial projects, it allows intuitive dimming, scene control, and remote configuration through a user-friendly mobile app. It's especially useful for retrofit applications where rewiring is cost-prohibitive.



Lutron Athena is a high-performance lighting control platform that combines tunable white, precision dimming, and cloud-based scene management. LITON's fixtures easily integrate to support advanced lighting design in architectural environments. Athena is ideal for projects that require both wired and wireless control within the same building.



Lutron Vive offers a flexible wireless control system for commercial spaces, using sensors and switches to enable easy retrofitting, scheduling, and dimming. LITON fixtures pair seamlessly with Vive to help maximize energy efficiency and lighting flexibility. The system can be installed zone-by-zone, allowing phased upgrades over time.



Synapse provides a long-range RF-based wireless system ideal for large-scale outdoor applications. When paired with LITON luminaires, Synapse enables real-time energy monitoring, dimming, and scheduling for parking lots, campuses, and industrial sites. It supports central cloud management, making it easy to maintain and optimize multiple locations remotely.



BubblyNet offers secure Bluetooth Mesh control without the need for internet access or gateways. LITON fixtures integrated with BubblyNet deliver scalable, flicker-free wireless lighting ideal for commercial interiors that demand reliability and flexibility. It enables local, device-to-device communication, reducing network vulnerability and latency.



LITON's exclusive low-cost UniSense™ technology integrates motion sensing and daylight harvesting directly into select luminaires. With stand alone programmable dimming and built-in automation, it's designed to improve safety, energy savings, and performance in outdoor environments. Settings can be tailored at the factory or adjusted on-site using a dedicated handheld programmer.

## Product Family Control Integration Chart

LITON PRODUCT	CASAMBI	LUTRON ATHENA	LUTRON VIVE	SYNAPSE	BUBBLYNET	UNISENSE
P-Series Recessed Downlights	•	•			•	•
Cylo Cylinders	•	•			•	•
CyloPro Adjustable Cylinders	•	•			•	
Apollo LED Track Lighting	•	•			•	•
LumenPad Surface Downlighting	•	•			•	•
C-Series Recessed Downlights	•	•	•		•	•
LumenBlast Recessed Downlights	•	•	•		•	
LumenCannon Cylinders	•	•			•	•
BL7 Bollards	•			•	•	•
BL3 Bollards	•			•	•	
LumenPole Bollards & Columns	•			•	•	•
AG2 Adjustable Flood/Spot Lighting	•			•	•	•
AG3 Flood/Spot Lighting				•		
DL Ceiling Lighting	•			•	•	•
WS Ceiling Surface				•	•	
WD Wall Lighting	•			•	•	•

## Quick Comparison: Why Choose One Control Over the Other?

CONTROL SYSTEM	BEST FOR	KEY BENEFIT
Casambi®	Small to mid-sized commercial & retail	Simple Bluetooth mesh, no gateway needed
Lutron® Athena™	High-end hospitality & commercial	Customizable lighting scenes, wired & wireless hybrid
Lutron® Vive™	Retrofits & large buildings	Wireless RF, fast installation, occupancy sensors
Synapse®	Outdoor smart lighting	Long-range mesh network, cloud-based control
BubblyNet®	Secure commercial applications	Decentralized Bluetooth Mesh, no internet dependency
UniSense™	Outdoor motion & daylight sensing	Low cost stand-alone control

# P·SERIES

Precision recessed downlighting in small apertures.



## 1.5", 2.5" & 3.5" Downlighting

SPECIFICATION GRADE

Designed for high-end residential, architectural, and commercial use. Provides exceptional ambient, accent, and task lighting in low to medium height ceilings.

### BENEFITS

- U.S. assembled
- Compact designs
- Modular and customizable
- Airtight and wet-location rated
- Precision lighting for displays and accents
- Wood recessed option

### Round or Square

Size	Round Downlight	Round Wallwash	Square Downlight	Square Wallwash
1.5"	<b>LRXLD1521</b> Round Downlight 500lm-1,000lm (6W-12W)	<b>LRXLD1573</b> Round Wallwash 500lm-1,000lm (6W-12W)	<b>LRXLDQ1521</b> Square Downlight 500lm-1,000lm (6W-12W)	<b>LRXLDQ1573</b> Square Wallwash 500lm-1,000lm (6W-12W)
2.5"	<b>LRXLD2621</b> Round Downlight Bevel 1,000lm-2,400lm (15W-22W)	<b>LRXLD2673</b> Round Wallwash 1,000lm-2,400lm (15W-22W)	<b>LRXLDQ2621</b> Square Downlight Bevel 1,000lm-2,400lm (15W-22W)	<b>LRXLDQ2673</b> Square Wallwash 1,000lm-2,400lm (15W-22W)
3.5"	<b>LRXLD3521</b> Round Downlight Bevel 600lm-3,000lm (7W-30W)	<b>LRXLD3573</b> Round Wallwash 600lm-3,000lm (7W-30W)	<b>LRXLDQ3521</b> Square Downlight Bevel 600lm-3,000lm (7W-30W)	<b>LRXLDQ3573</b> Square Wallwash 600lm-3,000lm (7W-30W)

Trimless downlight reflectors are shown. Trimless adjustable reflectors, flanged downlight, and flanged adjustable reflectors are also available.

### CONTROL



### 1.5" & 2.5" OPTICS

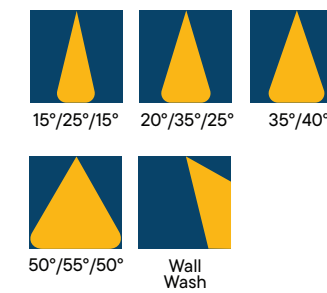

### LUMEN RANGE

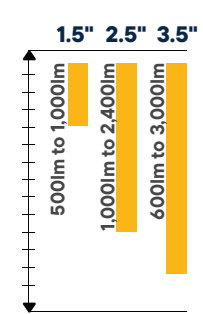

### SUPER-SHALLOW HOUSING COMING SOON!



### FINISHES

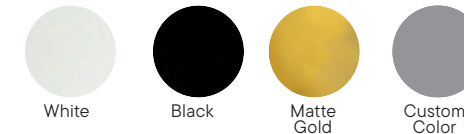

LINK TO WEB PAGE

# P-SERIES CYLINDERS

Scalable, precision & uniformity.

## Precision Small Aperture Cylinders

SPECIFICATION GRADE

Delivering compact high-performance illumination, the new P-Series precision cylinders are designed for versatility and architectural integration. They are available in 1 & 2-direction, wall & surface-mount, track, and pendant options.

### BENEFITS

- Compact small-aperture design for a sleek, modern look
- Multiple mounting options for versatile applications
- Consistent aesthetics for cohesive designs
- High-performance optics with precise beam control
- Up/Down and dual-direction options for layered lighting
- Compatible with dimming and wireless controls

### Small, Medium & Large Sizes

#### LWMLD5PJ1

Adjustable Spot

SM	MED	LG
1.18"Ø	1.57"Ø	1.97"Ø
6.7"H	7.5"H	7.9"H
880lm (10W)	1,880lm (20W)	2,970lm (30W)

#### LWMLD5P1

Wall 1-Direction

SM	MED	LG
1.18"Ø	1.57"Ø	1.97"Ø
6"H	6"H	6"H
504lm (6W)	595lm (7W)	1,080lm (12W)

#### LWMLD5P2

Wall 2-Direction Up/Down

SM	MED	LG
1.18"Ø	1.57"Ø	1.97"Ø
12"H	12"H	12"H
2 x 504lm (2 x 6W)	2 x 595lm (2 x 7W)	2 x 1,080lm (2 x 12W)

#### DL5P1

Pendant

SM	MED	LG
1.18"Ø	1.57"Ø	1.97"Ø
12"H	12"H	12"H
504lm (6W)	595lm (7W)	1,080lm (12W)

Coming Q1 2026

### CONTROL



### OPTICS

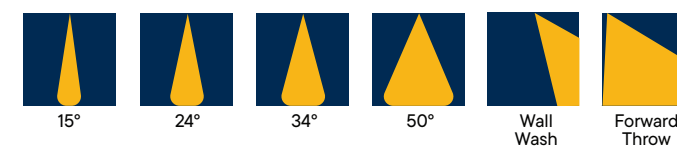

### FINISHES



### ACCESSORIES

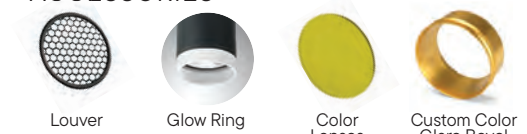

### LUMEN RANGE

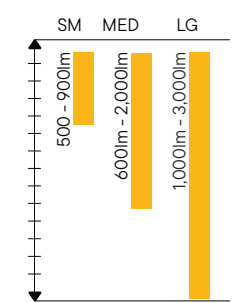

P-SERIES  
**MATRIX™**

Scalable, precision & uniformity.

MATRIX TRIMLESS WOOD OPTIONS



Specify (-WD) under Mounting in the Order Configurator.

ModuLED Matrix (MXLFG1-115) & (MXLFG1-101) shown.

**Miniature Linear LED**

Matrix recessed linear wall washes and downlights are an aesthetic and performance upgrade from traditional linear fluorescent lighting bringing elegance and flexibility to a variety of lighting applications.

SPECIFICATION GRADE

**BENEFITS**

- Competitively priced modular design
- Lumen packages up to 33W, 3,000lm delivered
- 15°, 30°, 40° beam spreads
- Adjustable versions pivot ±25°
- Glare free, precision, uniform lighting

**Trimless Configurations**

**MXLTS1-101**  
1-Cell  
200lm (2W)



**MXLTS1-105**  
5-Cell  
1000lm (10W)



**MXLJTS1-105**  
5-Cell Adjustable  
1,000lm (10W)



**MXLTS1-102**  
2-Cell  
400lm (4W)



**MXLTS1-110**  
10-Cell  
Trimless  
2000lm (20W)

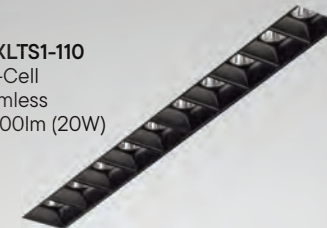

**MXLJTS1-110**  
10-Cell Adjustable  
2,000lm (20W)



**MXLTS1-202**  
4-Cell  
800lm (8W)



**MXLTS1-115**  
15-Cell  
3000lm (33W)



**MXLJTS1-115**  
15-Cell Adjustable  
3,000lm (33W)



Available in Flanged (MXLFG1) and Surface (MXLSRF1). See moduled.io website for more information.

**CONTROL**



**OPTICS**

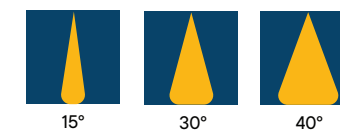

**LUMEN RANGE**

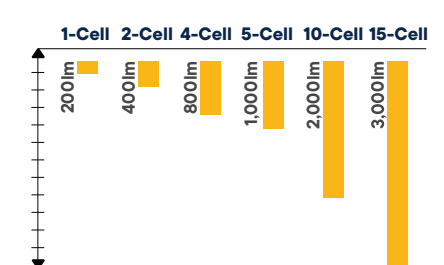

**FINISHES**



**FEATURES**



\*On selected 5, 10, and 15-cell luminaires.



LINK TO WEB PAGE

# LUMENBLAST

Ultra-efficient high output precision recessed downlighting with intense CBCP.



LumenBlast is ideal when high lumen output is needed.

## High Lumen Downlighting



SPECIFICATION GRADE

LumenBlast downlights are designed to provide high lumen output for medium to high ceilings in architectural and commercial spaces.

### BENEFITS

- Powerful illumination for high ceilings (1,000–10,000 lumens)
- Adjustable trims for flexible lighting applications
- Advanced dimming for precise control and energy savings
- Versatile models for damp, wet, and sloped ceilings

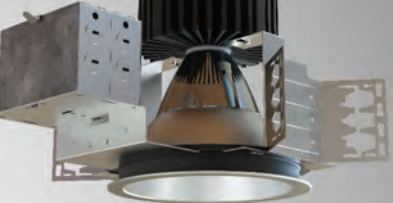
### Round or Square

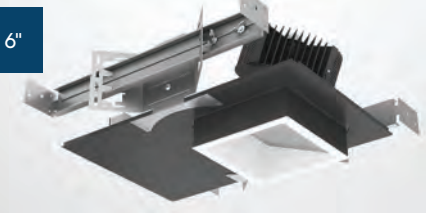
<p>4"</p>  <p><b>LHABLD4/LHAJLD4</b> 4" Round Downlight &amp; Adjustable Accent Wall Wash 1,000lm to 7,000lm (9W-64W)</p>	<p>6"</p>  <p><b>LHABLD6/LHAJLD6</b> 6" Round Downlight &amp; Adjustable Accent Wall Wash 1,000lm to 10,000lm (9W-116W)</p>	<p>8"</p>  <p><b>LHABLD8</b> 8" Downlight 1,000lm to 10,000lm (9W-116W)</p>
<p>4"</p>  <p><b>LHAJLDQ4</b> 4" Square Adjustable Accent 1,500lm to 5,000lm (9W-60W)</p>	<p>6"</p>  <p><b>LHAJLDQ6</b> 6" Square Downlight &amp; Adjustable Accent Wall Wash 1,500lm to 10,000lm (11W-116W)</p>	

### CONTROL



### OPTICS

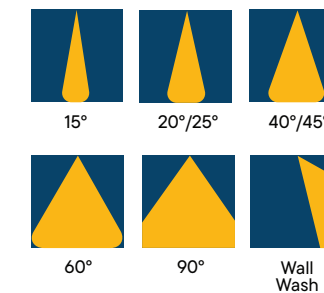

### LUMEN RANGE

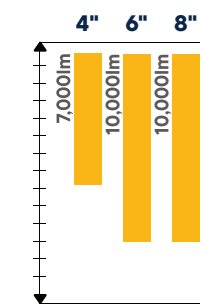

**SUPER-SHALLOW  
4,000 LUMEN  
HOUSING  
COMING SOON!**



### FINISHES



### FEATURES



LINK TO WEB PAGE

# C·SERIES

Versatile recessed downlighting with several beam and dimming options.

## 4"-10" Architectural Downlighting

ARCHITECTURAL GRADE

### BENEFITS

- Compact, high-output designs
- Flexible beam spreads and trim options
- Excellent thermal management
- Energy-efficient and cost-saving
- Easy to install and maintain

### Round or Square

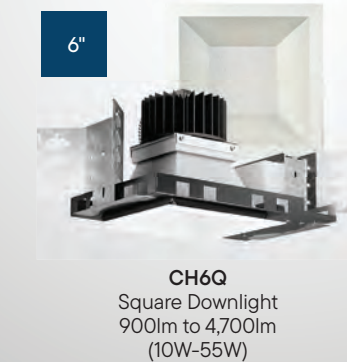

New Construction shown. Also available in Retrofit/Remodel.

### CONTROL



### OPTICS

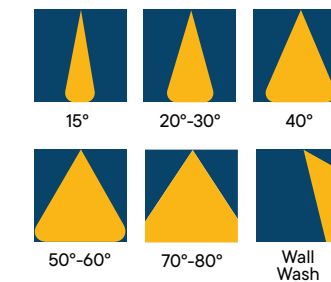

### LUMEN RANGE

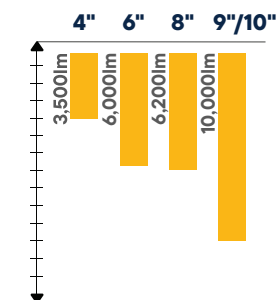

### FINISHES

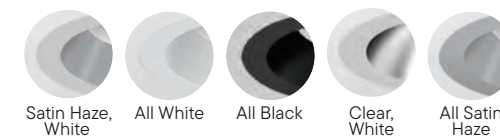

### OPTIONS

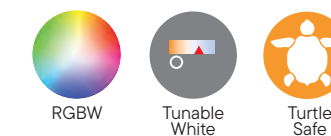

### FEATURES



LINK TO WEB PAGE

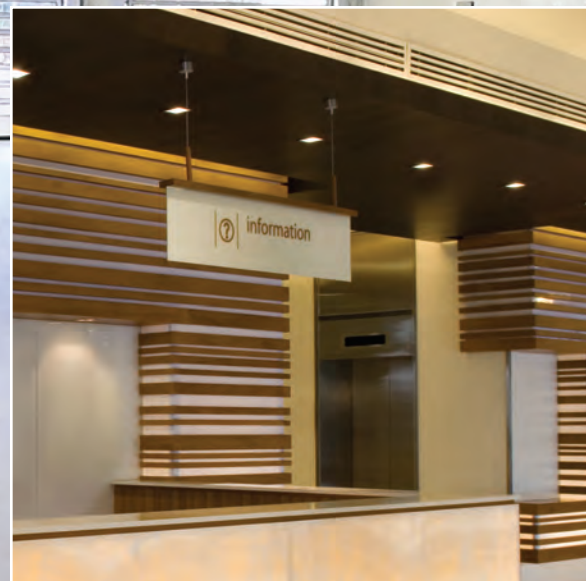

CH4Q shown in inset.

# MINI-ARC

A perfect balance of precision and presence.



Mini-Arc is available with new construction or remodel housings

## 2", 3", & 4" Miniature Downlights

ARCHITECTURAL GRADE

This miniature general-purpose LED trim is perfect for low to medium height ceilings in residential and light commercial applications. Its small aperture makes it ideal for strategic placement where space is limited and energy savings is important.

### BENEFITS

- Diecast trims
- Fire-rated
- Smooth, flicker-free dimming down to 1%
- UniDim™ 0-10V, TRIAC/ELV Dimming (120V/277V)
- Emergency backup

### 2" Trim



**LRLD1221**  
Smooth Reflector  
700lm (10W)



**LRLDQ221**  
Smooth Reflector  
700lm (10W)



**LRLD1288**  
Adjustable Gimbal  
700lm (10W)



**LRLDQ288**  
Adjustable Gimbal  
700lm (10W)



**LRLD1293**  
Baffle Reflector  
700lm (10W)



**LRLDQ293**  
Baffle Reflector  
700lm (10W)

### 3" Trim



**LRLD1321**  
Baffle Reflector  
700lm/1,000lm  
(10W/13W)



**LRLD1319**  
Pinhole Reflector  
500lm (10W)



**LRSQD1319**  
Square Pinhole Baffle  
600lm/1,000lm  
(10W/13W)



**LRLD1388**  
Gimbal Reflector  
700lm/1,000lm  
(10W/13W)

### 4" Trim



**LRLD1431**  
Smooth Reflector  
700lm/1,000lm  
(10W/13W)



**LRLD1467**  
Pull Down  
700lm (10W)



**LRLD1419**  
Pinhole  
500lm (10W)



**LRLD1420**  
Adjustable Slot  
550lm (10W)



**LRSQD1419**  
Square Adjustable  
700lm/1,000lm  
(10W/13W)

### CONTROL



### OPTICS



25°

40°/45°

60°

### FINISHES



White



Black



Natural<sup>1</sup>

<sup>1</sup>Special Order Finish.

# LUMENCANNON

High-lumen, high-candle power cylindrical downlighting for indoor applications.

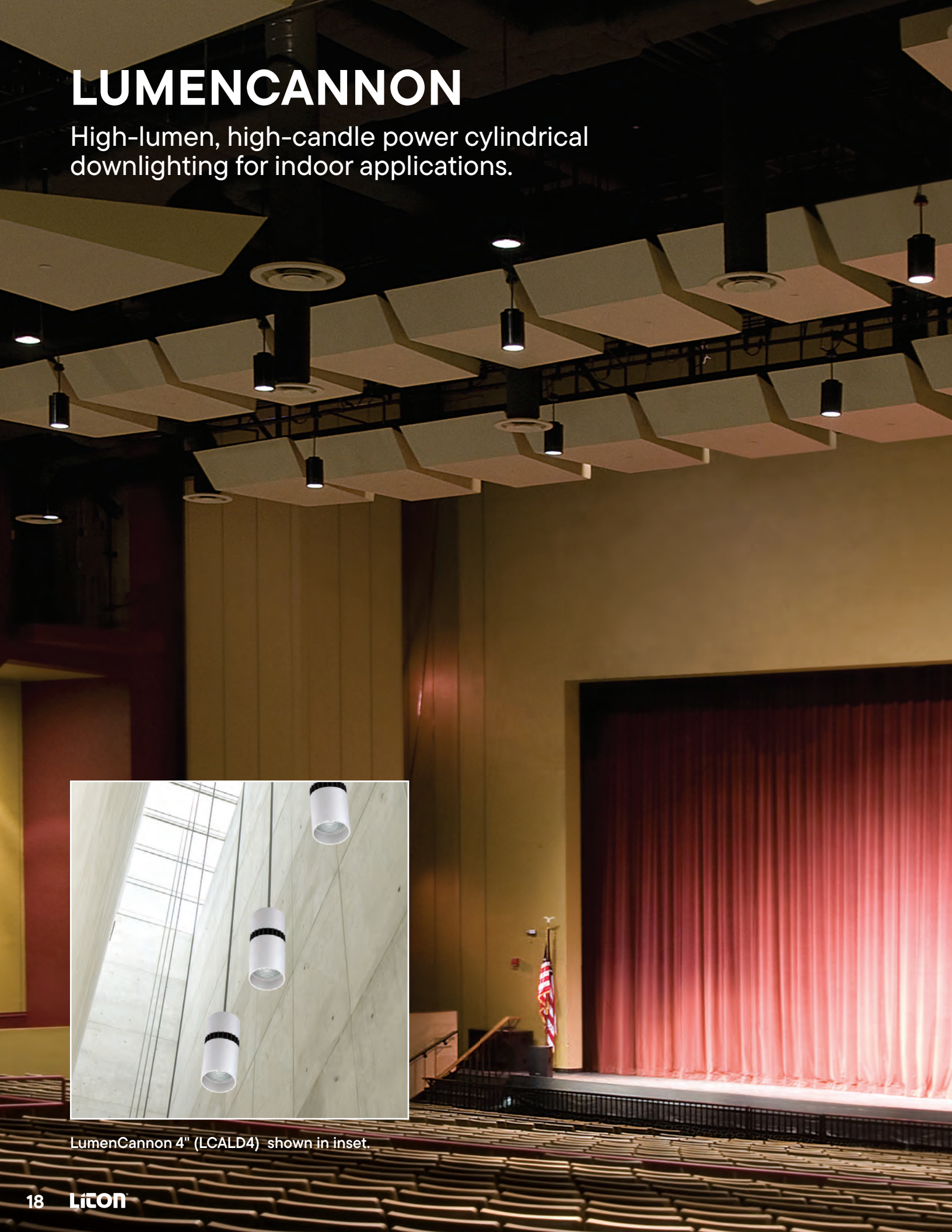

LumenCannon 4" (LCALD4) shown in inset.

## High Lumen Cylinders

SPECIFICATION GRADE

Award winning architectural LED cylinders in surface, wall and pendant mounts. Designed for high lumen output in commercial and architectural applications.

### BENEFITS

- High-power illumination for large spaces
- Customizable beam spreads
- Energy-efficient and low maintenance
- Durable for high-ceiling installations

### Three Sizes – 4", 6" & 8" dia.

4"



**LWMLD4**  
4" Downlight  
Wall Mount  
1,000lm-2,600lm  
(10W-30W)

4"



**LCALD4**  
4" Downlight  
Pendant/Ceiling Mount  
1,000lm-2,600lm  
(10W-30W)

6"



**LCALD6**  
6" Downlight  
Pendant/Ceiling Mount  
1,100lm-6,000lm  
(10W-58W)

8"



**LCALD8**  
8" Downlight  
Pendant/Ceiling Mount  
2,900lm-16,000lm  
(28W-160W)

6"



**LWMLD6**  
6" Downlight  
Wall Mount  
1,100lm-6,000lm  
(18W-60W)

### MOUNTING OPTIONS

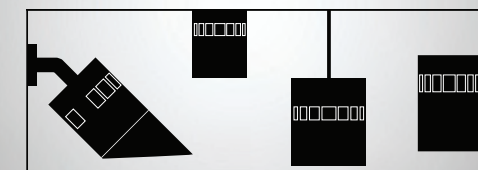

Wet location configurations available. Consult factory.

### CONTROL



### OPTICS

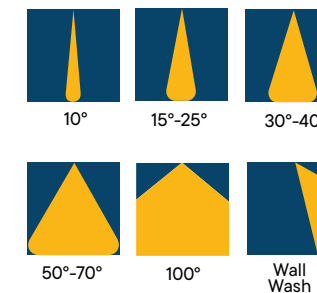

### LUMEN RANGE

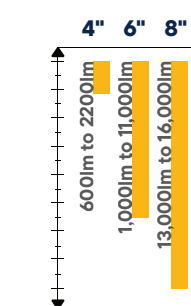

### FINISHES

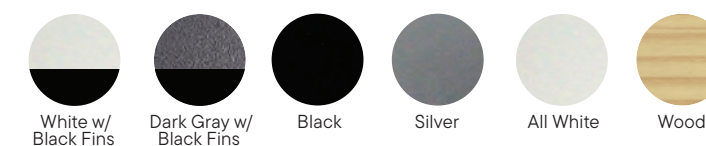

LINK TO WEB PAGE

# CYLO

Compact indoor cylinder lighting with a multitude of sizes and mounting options.



## Cylinders

ARCHITECTURAL GRADE

These small yet powerful wall, canopy, and track mounted adjustable cylinder fixtures are great accent lighting solutions for retail, commercial and residential applications.

### BENEFITS

- Blends seamlessly into contemporary architecture
- High-quality light output, enhances visibility
- TIR optics for low glare and optimum light control
- Color temperature switch for achieving desired mood

### Pendant, or Surface Mount



**LWMLD4CJ3**  
Cylo Adjustable Monopoint  
1,000lm/1,800lm  
(10W/20W)



**DL4C3**  
Cylo Ceiling/Surface  
1,000lm-3,600lm  
(10W/36W)



**DL4P3**  
Canopy Mount Pendant  
1,000lm/3,600lm  
(10W-36W)



**LWMLD4C23**  
Cylo 2-Direction Wall Mount  
2 x 1,000lm/1,800lm  
(20W/40W)

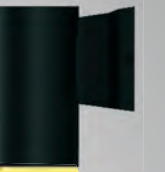

**LWMLD4C3**  
Cylo 1-Direction Wall Mount  
1,000lm-3,600lm  
(10W/36W)

### CYLO MOUNTING OPTIONS



### CONTROL



### OPTICS

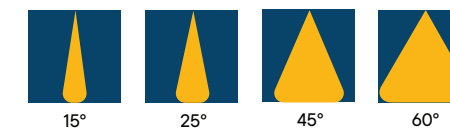

### LUMEN RANGE

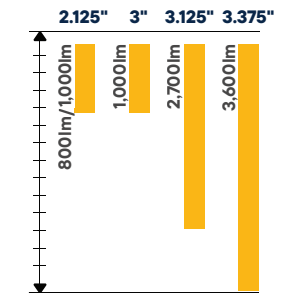

### FINISHES

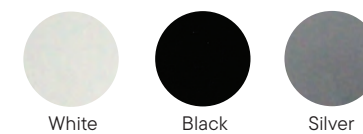

### OPTIONS (For Selected Products)



LINK TO WEB PAGE

# CYLO TRACK

Compact indoor cylinder lighting with a multitude of sizes and mounting options.



## Cylo Track Lighting

ARCHITECTURAL GRADE

These small and powerful track mounted adjustable cylinder fixtures are great accent lighting solutions for retail, commercial and residential applications.

### BENEFITS

- Blends seamlessly into contemporary architecture
- High-quality light output, enhances visibility
- TIR Optics for Low Glare and Optimum light control
- Color Temperature Switch for achieving desired mood
- Durable, low-maintenance

### For Standard H-Style 1 & 2 Circuit Track

J & L-Type Connectors Available with Extended Lead Time



### CONTROL



### OPTICS

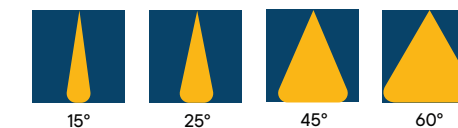

### LUMEN RANGE

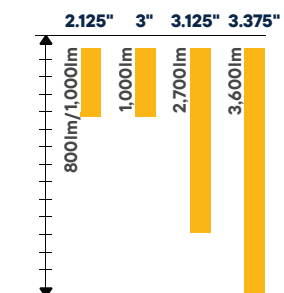

### FINISHES

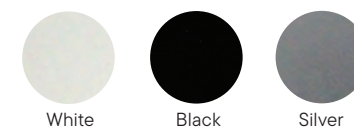

LINK TO WEB PAGE

# CYLOPRO

Compact adjustable indoor cylinder lighting.

## Adjustable Cylinders

SPECIFICATION GRADE

These specification-grade surface, pendant, and track mount adjustable LEDs provide the flexibility to put the light where you want it, whether into tight corners or accenting your favorite artwork.

### BENEFITS

- Sleek cylindrical design
- Flexible mounting options
- High-quality light output
- Durable and low-maintenance.

### Pendant, Track or Surface Mount

2.5"



**LCALDJ2**  
CyloPro  
2.5" Surface/Pendant  
700lm/1,000lm  
(10W/15W)

3.5"



**LCALDJ3**  
CyloPro  
3.5" Surface/Pendant  
1,500lm/2,000lm  
(20W-30W)

5"

Up to 340°  
Rotation

Up to 90°  
Angle



**LCALDJ5**  
CyloPro  
5" Surface/Pendant  
2,500lm/3,500lm  
(30W-45W)

### CYLOPRO MOUNTING OPTIONS

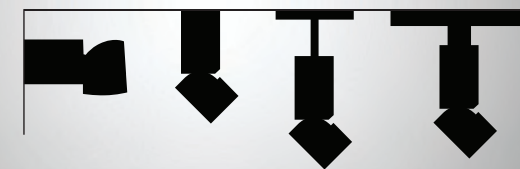

### CONTROL



### FINISHES

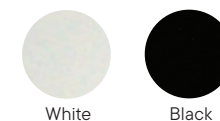

### OPTICS

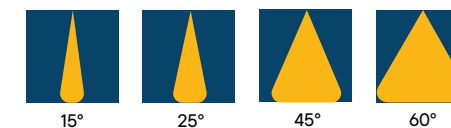

### LUMEN RANGE

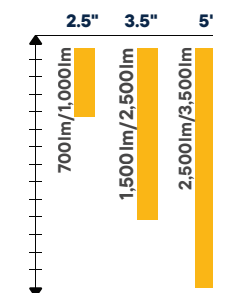

LINK TO WEB PAGE

## ColorFlush DMX RGBW Downlight

ARCHITECTURAL GRADE

Perfect for applications desiring a dynamic color changing effect. RGBW design allows fine-tuned pastel colors, saturated hues without sacrificing illumination brightness. Recommended for retail, modern residential, hospitality and entertainment installations.

### BENEFITS

- Smooth, flicker-free dimming of all colors down to 1%
- Static Colors Available
- DMX control via LCD screen selection
- 5-Year Warranty

### New Construction, Remodel, and Retrofit

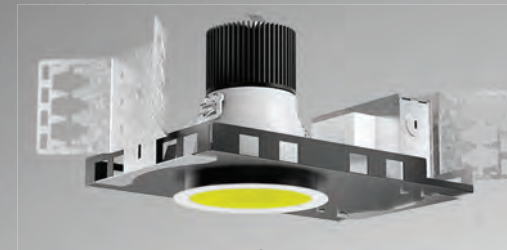

**SR4**  
4" RGBW  
Recessed Downlight  
600lm max. (20W)



**SR6**  
6" RGBW  
Recessed Downlight  
1,330lm max. (48W)



**SR8**  
8" RGBW  
Recessed Downlight  
1,400lm max. (48W)

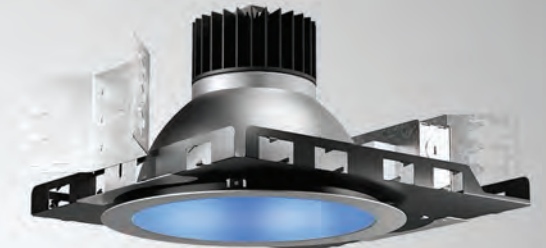

**SR10**  
10" RGBW  
Recessed Downlight  
1,450lm max. (48W)

#### CONTROL



#### OPTICS



80°

#### FINISHES



Satin Haze, White All White All Black

#### FEATURES



RGBW

**CASAMBI**

#### LUMEN RANGE

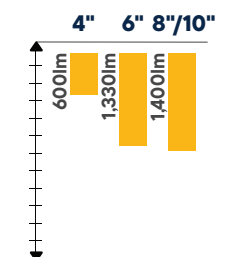



## ColorPad DMX RGBW Surface

ARCHITECTURAL GRADE

Ultra-low profile, easy install alternative to recessed lighting for plenum-challenged spaces with average ceiling heights. RGBW Design allows fine-tuned pastel colors or saturated hues without sacrificing illumination brightness. Recommended for retail, hospitality, entertainment venues, corporate branding.

### BENEFITS

- Smooth, flicker-free dimming of all colors down to 1%
- Static Colors Available
- DMX direct via remote data enabler
- 5-Year Warranty

### 1" Height Ultra-Low Profile



**SPD7**  
7" RGBW  
Surface Mount  
700lm max. (32W)



**SPD12**  
12" RGBW  
Surface Mount  
1,000lm max. (80W)

### CONTROL



### OPTICS



120°

### FINISHES



White

### FEATURES



RGBW

**CASAMBI**

### LUMEN RANGE

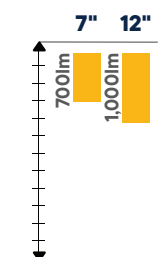

LINK TO WEB PAGE

Indirekt adds a modern flare to any architectural design.



Indirekt Wall Bars provide ambiance to indoor & outdoor settings.

## Indirekt Wall Bars

SPECIFICATION GRADE

A sleek wall fixture designed for elegant, low-glare illumination, the Indirekt Wall Bars offer durable performance with a refined aesthetic, perfect for indoor or outdoor use.

### BENEFITS

- ADA Compliant for any location
- Multiple Sizes, finishes, and color temperatures for maximum applications
- IP65 Rated for outdoor use
- Sleek, appealing, and beautifully designed
- Low Glare for comfort
- Marine Grade Option for coastal applications

### 12", 24", 36", 48" & 72" Heights



LWM312  
12" Wall Bar  
1,000lm (15W)



LWM324  
24" Wall Bar  
2,000lm (28W)



LWM336  
36" Wall Bar  
2,100lm (30W)



LWM348  
48" Wall Bar  
2,800lm (40W)



LWM372  
72" Wall Bar  
4,200lm (60W)

### CONTROL



### FINISHES



### FEATURES



Characters can be etched into the shield for wayfinding.



LINK TO WEB PAGE

\*Special Order Finish.

# LUMENPAD

Slim, edge-lit luminaires in flush mount and pendant options.



## Slim Surface Mounted Downlighting

ARCHITECTURAL GRADE

Super thin flush mount and pendant luminaires are edge-lit for smooth, glare-free output for retrofit, new construction and remodel applications in low to medium height ceilings.

### BENEFITS

- Slim profile for modern spaces
- Uniform illumination for large areas
- Customizable configurations
- Durable and energy-efficient

### Pendant, Surface or Wall Mount

5"



**LCMPD5R/Q**  
5" Round & Square  
Surface  
1,000lm (11W)

7"



**LCMPD7R/Q**  
7" Round & Square  
Surface  
1,100lm/1,400lm (14W)

12"

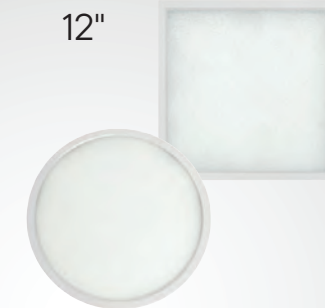

**LCMPD12R**  
12" Round & Square  
Surface  
2,000lm (22W)

18"



**LCMPD12RP**  
18" Round Surface  
2,800lm (30W)

### MOUNTING OPTIONS

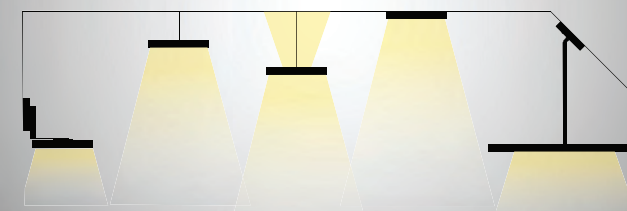

### NEW BEVELED OPTION



Pendants are also available with a combined Downlight/Uplight. See webpage.

### ADDITIONAL LUMENPAD PRODUCTS



Vandal Resistant (LCMPD-VR)

Recessed Emergency (LCMPD-REMA)

### CONTROL



### OPTIONS



RGBW

### LUMEN RANGE

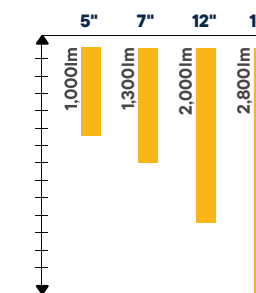

### FINISHES

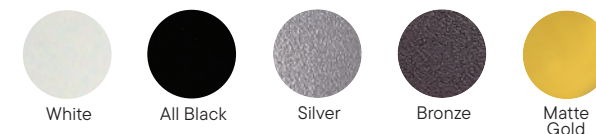

LINK TO WEB PAGE

# APOLLO

Architecturally-styled high output Apollo LED Track Heads are perfect for applications where powerful lumen output is required.

## BENEFITS

- Fully die-cast for high quality, long-lasting beauty
- Up to 4 beam spread options for fine-tuning foot candle distribution
- Powerful lumen output lights objects near and far
- T4 & T6 performance in a long life, cool running LED track head
- Available with Tool-less field changeable optics

SPECIFICATION GRADE

# SATURN

Saturn LED track heads feature a durable steel body and futuristic alloy heat sink. Their small, unobtrusive size makes them ideal for retail, commercial and residential applications.

## BENEFITS

- Concealed heat sink, hardware and wiring
- ELV Dimming standard
- Precision design insures firm positioning
- Color matched, thermo-formed synthetic driver box
- Stylish designs for appealing illumination

ARCHITECTURAL GRADE

## For Standard H-Style 1 & 2 Circuit Track

J & L-Type Connectors Available with Extended Lead Time

## For Standard H-Style 1 & 2 Circuit Track

J & L-Type Connectors Available with Extended Lead Time

20W



LTD7410/LTD7415  
Apollo 10/15  
2.75" dia. Track Head  
1,100-1,500lm  
(16W-21W)

32W



LTD7430  
Apollo 30  
3.625" dia. Track Head  
2,900lm (32W)

60W



LTD7450/LTD7460  
Apollo 50/60  
4.755" dia. Track Head  
4,500lm-6,000lm  
(48W-60W)



LTD7310  
Saturn Metal Cone  
720lm (10W)



LTD7314  
Saturn Metal Mesh  
720lm (10W)



Up to 280°  
Rotation

LTD7316  
Saturn Small Glass  
720lm (10W)

## CONTROL



## FINISHES

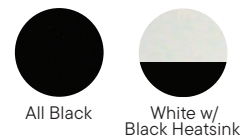

## LUMEN RANGE

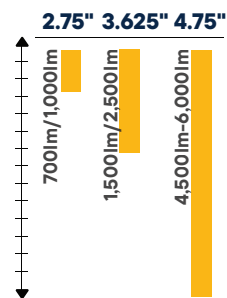

## OPTICS

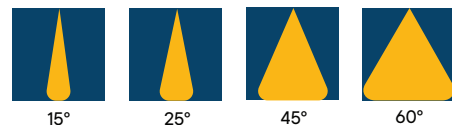

## FEATURES



LINK TO WEB PAGE

## CONTROL



## OPTICS



## LUMEN RANGE

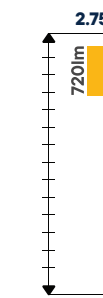

## FINISHES



LINK TO WEB PAGE

Bring the Cluttered Ceiling In-Line.



ModuLED 1.5" Recessed Trimless Slot Stealth AC (MCTRSTS) shown with Linear Diffused module (MC1).

## AC Rectilinear Modular Slot

SPECIFICATION GRADE

The direct 120V and 277V powered modules offer the simplicity of AC installation without the challenge of bulky remote step down transformers. Stealth modules snap easily into the 120V/277V AC direct slot, and mix or match for a custom layout.

### BENEFITS

- More lumens up to 4,000lm for 8' MC1
- More brains - DALI/DMX dimming, and EcoSystem compatible
- Less circuits - up to 4-circuits and indirect dimming
- Less wiring - 120V/277V/347V integral power supply
- No voltage drop or remote drivers

### Recessed Trimless Modular Slot AC (MCTRSTS)

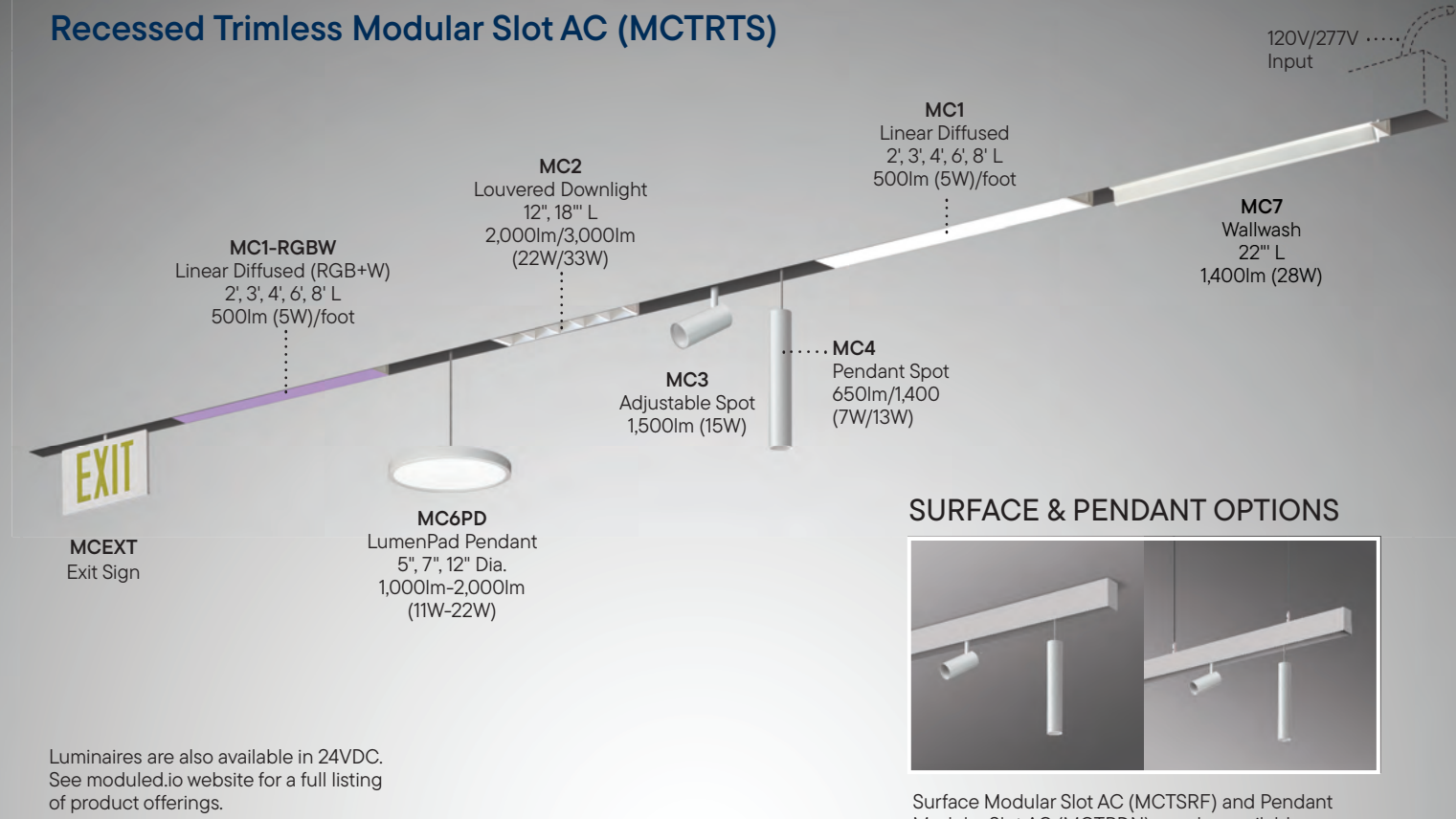

### CONTROL

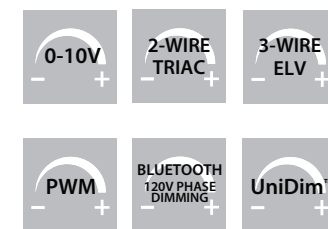

### OPTICS

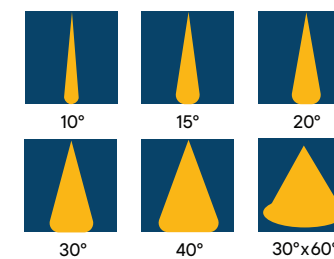

### FINISHES

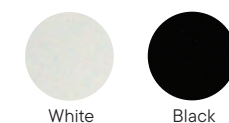

### FEATURES



LINK TO WEB PAGE

# DĀLUME®

Miniature linear lighting solutions.



Dalume Pendant (DMC-D)

## Dalume Architectural Grade

ARCHITECTURAL GRADE

Miniature linear lighting for educational, commercial, healthcare, and more. Available in flanged, trimless, surface, and pendant with optional uplight.

### BENEFITS

- Modern design paired with advanced technology balancing form and function.
- Offers a broad product range to meet many design and lighting requirements
- Energy-efficient solutions for sustainability and reduced operating costs
- High-quality illumination and low glare for aesthetics and comfort

### 1', 2', 4', 8' Length (120V/277V or 347V)

#### Surface



**DCG1**  
1" Surface  
1,600lm-6,500lm  
(8W-96W)



**DCG2**  
2" Surface  
900lm-10,000lm  
(16W-192W)



**DMC-S/WMD**  
2" Surface High Efficiency  
375lm-8,800lm  
(4W-96W)



**DCR-SM**  
1" Surface  
with Wrapped Lens  
375lm-8,800lm  
(4W-96W)

#### Pendant



**DCR-D**  
1" Pendant with  
Wrapped lens  
375lm-8,800  
(4W-96W)



**DMC-D**  
2" Pendant  
375lm-8,800  
(4W-96W)

#### Recessed



**DCR-RS**  
1" Recessed Trimless  
Drywall Depth  
375lm-8,800  
(4W-96W)



**DCR-RV**  
1" Recessed Flanged  
375lm-8,800  
(4W-96W)



**DMC-RS**  
2" Recessed Trimless  
375lm-8,800  
(4W-96W)

### CONTROL

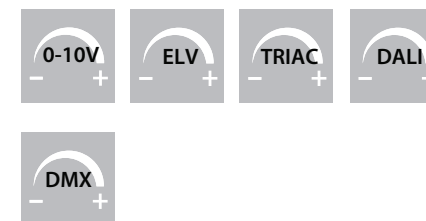

### FINISHES

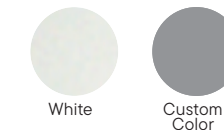

### LUMEN RANGE

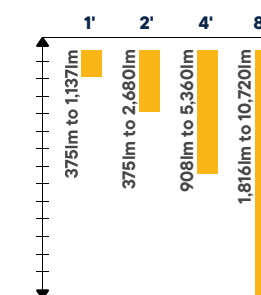

### FEATURES



LINK TO WEB PAGE

# DALUME®

Miniature linear lighting solutions.

## Dalume Architectural Grade (Cont.)

ARCHITECTURAL GRADE

Miniature linear lighting for wall wash applications, horizontal and vertical surface accents, and general illumination.

### BENEFITS

- Minimal design with advanced economic technology for a reliable, clean product
- Several design options to meet various lighting requirements and design preferences
- Energy-efficient for sustainability and reduced operating costs
- High-quality illumination for aesthetics & comfort

### 1', 2', 4', 8' Length (24V)

Surface

24V

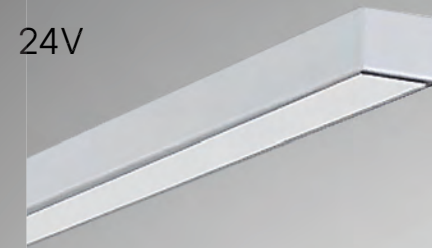

**DCG4**  
1" Gridlyte Pro  
Lensed  
1,500lm-3,000lm  
(15W-30W)

24V



**DCG5**  
1" Gridlyte Pro  
Low-Glare Louvered  
1,800lm-3,600lm  
(15W-30W)

24V



**DCG3**  
1" Gridlyte Pro  
Wall Wash  
1,600lm-3,200lm  
(15W-30W)

### DALUME MOUNTING OPTIONS

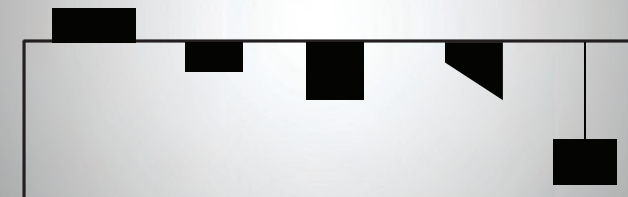

### CONTROL

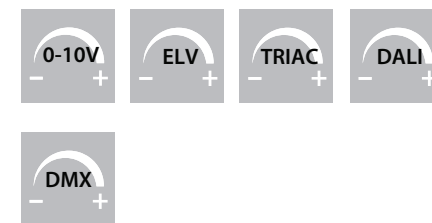

### FINISHES

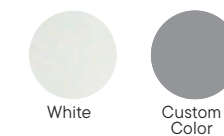

### LUMEN RANGE

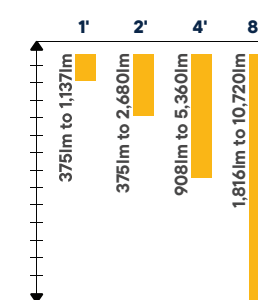

### FEATURES



Dalume 2" Surface High Efficiency (DMC-S)



LINK TO WEB PAGE

# ESSENTIAL GRADE LIGHTING

## Track, Surface, Recessed

LITON's Essential Grades are cost-conscious solutions for everyday performance. The Essential Grade Collection features basic glare control, mostly ColorSelect, and limited beam spread options to simplify specification. Many products are part of the

Ready2Ship program for fast delivery, with standard dimming capabilities and select models assembled in the U.S. They are ideal for budget driven projects that still demand quality and reliability.

## Track Lighting

### OPTIONS

- 1-Circuit/1-Neutral 120V (H-Type/J-Type/L-Type)
- 2-Circuit/1-Neutral 120V
- 2-Circuit/2-Neutral 120V/277V
- 3-Circuit/1-Neutral 120V/277V

### Front Loading Gimbals



### Standard Gimbals



## Track Lighting

ESSENTIAL GRADE

### Round Back Cylinder



### Flat Back Cylinder



### Mesh



### EuroShade



## Track Lighting & Surface Lighting

### Universal

- Economy track head For use with standard H-Style 1 circuit and 2 circuit track
- Accepts a wide variety of medium base PAR and general service A lamps



### LED Wall Wash



### Lumen Disc

- White polycarbonate diffuser eliminates hot spots for uniform light distribution.
- Removable translucent lens for easy cleaning.



### Dalume Lineo



### Professional Grade LED Stick

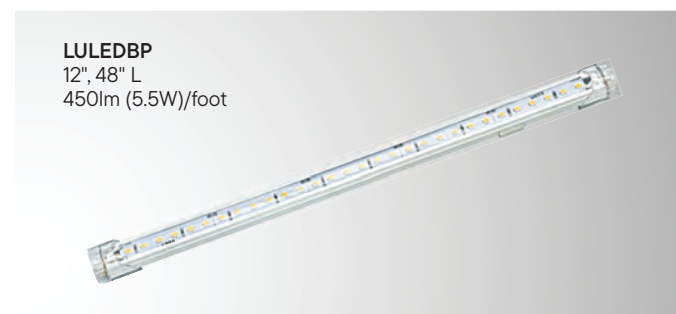

## General Purpose E-Series Recessed Lighting

- Reflector with Integral Driver and LED Ready Connector to line voltage
- Compact design eliminates complex wiring



### 4" 120V Trim (Driver Based)



### 6" Trim

