

BL2QZ-31/40: LUMENPOLE SQUARE BOLLARD

6" OPEN FRAME - 31", AND 40" HEIGHT
 650LM / 1400LM (8W / 18W)

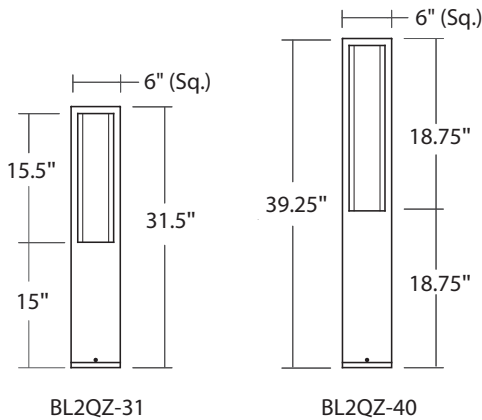

- Dark Sky Compliant
- U.S. Assembled
- Tamper Resistant Hardware
- IK08 Impact Rating
- Optional Photocell Sensor/ GFCI Provision and In-Use Cover
- Quick Ship Options Available
- 90 CRI Standard, 80 CRI on 5000K

ORDERING : BL2QZ-31B-L14-SYM-WUE-D10-T27-C90-SDL

BL2QZ	Finish	Lumens	Optic	Control	LED	Options	Openings
Height			Optic		Control		LED
31" Bollard	BL2QZ-31¹		Symmetric Extra Narrow (20°)	-SYM-EN⁷	Non-Dimming (120V)	Blank	2700K (90CRI) -T27-C90
40" Bollard	BL2QZ-40		Symmetric Narrow (45°)	-SYM-N⁷	TRIAC/ELV Dimming (120V)	-DIN⁹	3000K (90CRI) -T30-C90
Finish			Symmetric Wide (75°)	-SYM-W	0-10V Dimming (120/277V)	UE-D10	3000K (97 CRI) -T30-C97¹
Black	B		Asymmetric Forward Throw	-ASY-FT^{1,7}	UniDim™ 0-10V, TRIAC/ELV Dimming (120V/277V)	UE-DUN	3500K (90 CRI) -T35-C90
White	W²		Asymmetric Wide	-ASY-W^{1,7}	0-10V Dimming (347V)	-347-D10⁸	4000K (90 CRI) -T40-C90
Silver	S²				Dali Dimming (120V/277V)	UE-DLI^{1,3}	5000K (80 CRI) -T50
Bronze	BZ				Casambi Wireless Dimming (120V/277V)	-DCSM	Amber Lighting (590nm, Turtle Safe with Louver) -TAM-LVR⁵
Lumens					BubblyNet Wireless System (120V/277V)	-DBNT¹	Emergency Options
650lm (8W)	-L05				SimplySnap Wireless System (120V/277V)	-DSYN^{1,6}	None Blank
800lm (10W)	-L08				UniSense - Integral Motion/Photosensor (120V)	-SUN-INT¹	Remote Full Power Emergency Option -EMAC³
1100lm (14W)	-L10				UniSense - Integral Motion/Photosensor (120V/277V)	-SUN-INT-1227¹	Options
1400lm (18W)	-L14						None Blank
							Photocell Sensor -SDL³
							Surge Protector (120V/277V) -SRG³
							Cold Weather -CW⁴
							GFCI plug and cover -GFI⁹
							Frosted Lens -FR
							Marine Grade Finish -MGD²
							Openings¹
							None, Open all 4 sides Blank
							1 Side Closed /1
							2 Adjacent Sides Closed /2-90
							2 Opposing Sides closed /2-180
							3 Sides Closed /3-90

¹ Special order. Minimum Order, Extended lead time may apply. Consult Factory.
² Special Order Finish. Minimum order quantity (MOQ) applies. Orders less than MOQ are subject to a special paint set-up fee for the quantity ordered. Extended lead times may apply. Consult Factory.
³ Not rated for cold weather. Minimum fixture outdoor temperature 0°C (32°F).
⁴ Starting Temperature -40°C/-40°F. Only available with (UE-DUN) control option.
⁵ (-TAM-LVR) option only available with Lumens -L05, -L08, or -L10.
⁶ Special Order. Sent with surface mount JBOX to allow for direct-conduit entry.
⁷ Only Available for (-40) Height Option.
⁸ (-347-D10) option only available for Lumens (-L10) & (-L14)
⁹ (-GFI) intended for use with a 120V separate power input not connected to the luminaire power supply.

Custom RAL Color: Please note that we appreciate custom finishes. Custom finishes are subject to a special paint setup fee for the quantity ordered. Extended lead times may apply. Consult Factory.
 Consult factory for possible additional options including: USB, AC outlet, speaker hubs, wireless, node mounting, PC/Motion sensor, 7-pin photocell receptacle (C136.41 compliant) only w/shorting cap, accepts standard twist-lock photocell or PC/Control Node for wireless dimming control.

2025.09.22

SPECIFICATION

Application

6" Square LumenPole Light Columns and Bollards are designed for architectural relevance to intimate indoor and outdoor environments where pedestrian level illumination is required. The LED COB with reflector provides illumination downward on the ground to light walkways, public gathering spaces, gardens, along waterfronts and marinas and other public and private areas. Typical applications include residential, commercial, and retail.

Housing & Arms

Housing and Arms are high-grade robust aluminum extrusion. A clear tempered glass lens is sealed to the Faceplate with a silicone O-ring. The Faceplate and end caps are die-cast aluminum and seal the housing (top and bottom) using silicone O-rings. A fabricated aluminum mounting plate installs onto supplied stainless steel anchor bolts and secures to the housing with countersunk, Phillips head, stainless steel screws.

Mounting

The 5.7" square mounting plate with U-bracket installs supplied stainless steel anchorbolts (or other hardware) on a solid substrate. For specific mounting options see installation instructions.

Openings

Aluminum panels affixed to the inside of adjacent vertical support arms control the light emitting from the openings. Configurations available: No panels; 1 panel; 2 panels at 90°; 2 panels at 180°; 3 panels at 90°.

Finish

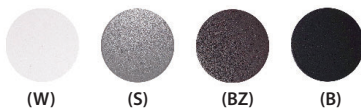

A 7-stage electrostatic, polymer process provides an outdoor powder coat finish that delivers outstanding durability, superior anti-aging, resistance to corrosion and UV-degradation.

Standard Finishes:

White: RAL 9005 (B)
Silver: RAL 7037 (S)
Bronze: RAL 8019 (BZ)
Black: RAL 9005 (B)

Consult factory for Custom Color.

Paint does not contain any copper compounds or elements.

Certifications and Listings



ETL / cETL Listed to UL1598 and UL8750 standards.

Suitable wet locations. (IP66)

Assembled in USA.

Dark Sky - Dark Sky compliant.

IK08 rated - Protected against 5 joules impact. Equivalent to impact of 1.7 kg mass dropped from 300 mm above impacted surface.

BL2QZ-31/40: LUMENPOLE SQUARE BOLLARD

6" OPEN FRAME - 31", AND 40" HEIGHT
650LM / 1400LM (8W / 18W)

SPECIFICATION (Continued)

Caution

LITON recommends use of surge protectors on incoming power. Locate them in the most convenient servicing location. Surge damage is not covered by warranty.

Warranty

Covered by a 5-Year Warranty to be free of defects in materials and craftsmanship. Fixture should not be installed in applications with ambient temperature above 60°C. Doing so will result in reduced lamp life and voided warranty.

Optic

A multifaceted aluminum coated reflector produces a Symmetric Wide (-SYM-W) 120° distribution.
-LVR option indicates an integral hexcell louver shield that meets Florida's FFWCC "Keep it SHIELDED" Wildlife Lighting Criteria to cut off glare in the horizontal plane of a lighting fixture.

LED

COB (Chip on Board) singular LED light source provides for smooth, uniform light output, eliminating the multiple imaging produced by multiple LED source optics. Binned with 4-step MacAdam ellipses as per ANSI Standard recommendation.

Lumen Maintenance

Minimum 50,000 hours L70 life based on ANSI TM-21 calculations from LM80 standardized test results.

Lumen Options (Delivered)

650lm (8W), 800lm (10W), 1100lm (14W), 1400lm (18W)

Color Temperature

COLOR TEMP:	2700K	3000K	3500K	4000K	5000K
CRI:	90	90	90	90	80

Amber: 590nm (Turtle Safe)

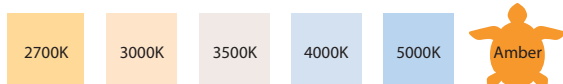

Quick Ship Items

- BL2QZ-31B-Lxx-SYM-WUE-DUN-T27-C90
- BL2QZ-31B-Lxx-SYM-WUE-DUN-T30-C90
- BL2QZ-31B-Lxx-SYM-WUE-DUN-T35-C90
- BL2QZ-31B-Lxx-SYM-WUE-DUN-T40-C90

Electrical

LED Driver: AC 50/60Hz Electronic Direct Current Class 2 driver integrally mounted. Incoming power connects to Terminal Blocks. Power Factor > 0.90.

Minimum Operating Temperature:

- Standard driver: -30°C/-22°F
- Cold Weather driver: -40°C/-40°F

Additional Options

Photocell (-SDL): Installed internally in fixture. Sensor enables automatic on/off operation based on ambient light levels, providing dusk-to-dawn functionality.



GFCI Outlet Provision W/In-Use Cover (-GFI): Factory installed GFCI provision and in-use cover in the luminaire.



Surge Protector(-SRG): Protects driver against surges in line voltage/current (20KV, 1.2/50µS & 10KA, 8/20µS). At end-of-life Suppressor opens the circuit to protect the driver. Surge suppressor is a perishable device requiring periodic replacement. Not a warranted item.

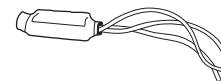

SPECIFICATION (Continued)

Control Options

ELV and TRIAC Driver 120V (-DIN):

Compatible with electronic low voltage, and 2-Wire incandescent dimmers. Also known as leading edge, Reverse Phase, Forward Phase dimming. Allows smooth dimming down to 5% depending upon the dimmer's limitations.

0-10V Driver 120V/277V (UE-D10):

Compatible with most existing 0-10V systems. Also known as fluorescent or 5-Wire dimming. Allows smooth dimming down to 5% depending upon the dimmer's limitations. Compatible with daylight harvesting controls.

UniDim™ Driver 120V/277V (UE-DUN):

All in one ELV and TRIAC phase dimming (120V only), and 0-10V dimming (120V/277V). Works with most 3-Wire ELV, 2-Wire incandescent and 120V/277V 5-Wire 0-10V fluorescent dimmers.

Incandescent/Phase Wiring
ELV

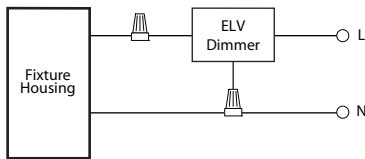

TRIAC

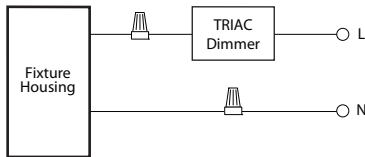

0 - 10V Wiring

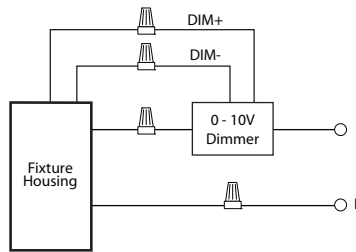

Incandescent/Phase Wiring
ELV

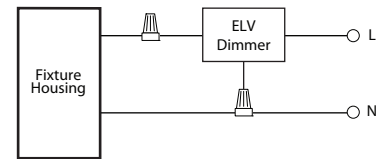

TRIAC

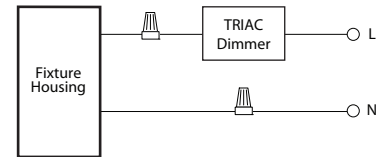

0 - 10V Wiring

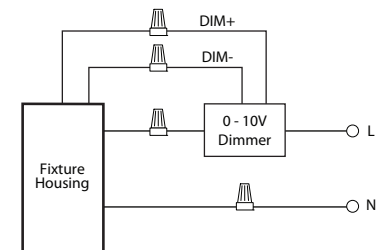

SPECIFICATION (Continued)

Marine Grade

The fixture features a marine-grade textured powder coat finish engineered to withstand extreme environmental conditions, including prolonged exposure to UV radiation, salt air, and moisture, which are prevalent in coastal and high-humidity environments.

A multi-stage surface preparation, finishing, and curing process ensures maximum adhesion, durability, and corrosion resistance. The coating system undergoes rigorous salt spray (ASTM B117) testing, overbake resistance verification, and pencil hardness testing to validate its robustness against degradation.

The marine-grade powder coat is applied as a 30–50 μm bottom layer, providing a strong anti-corrosion foundation. This is further enhanced by a surface coat using a standard architectural-grade powder application with a total thickness of 80–120 μm , ensuring superior resistance to wear, impact, and environmental stressors.

BL2QZ-31/40: LUMENPOLE SQUARE BOLLARD

6" OPEN FRAME - 31", AND 40" HEIGHT
650LM / 1400LM (8W / 18W)

PHOTOMETRY

BL2QZ-31B-L14-SYM-W-T40-C90 (31" Height, 1300lm*, 18W, Asymmetric Wide, 4000K)

System Power: 18.0 W
Test Date: 09/2023
Beam Angle 50%: 84.0°
Field Angle 10%: 114.5°
Color Temperature: 3987K
CRI: 94.2
Lumens Delivered: 1468
Power Factor: 0.99

MULTIPLIERS	
LUMEN PACKAGE	
-L05	0.46
-L07	0.57
-L10	0.78
-L14	1.00
CCT	
2700K :	0.91
3000K :	0.94
3500K :	0.97
4000K :	1.00
5000K :	1.04
OPTIONS	
-FR :	0.80

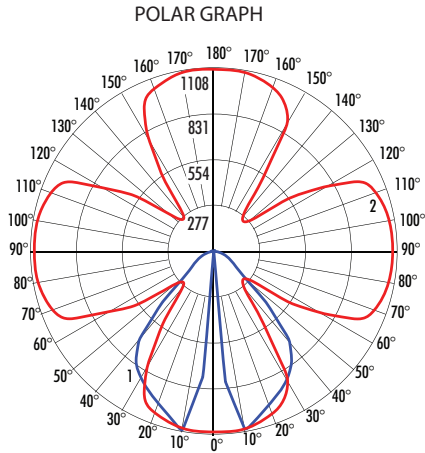

Maximum Candela = 1107.6 Located At Horizontal Angle = 95, Vertical Angle = 10
1 - Vertical Plane Through Horizontal Angles (90 - 275) (Through Max. Cd.)
2 - Horizontal Cone Through Vertical Angle (10) (Through Max. Cd.)

FOOTCANDLES ON GROUND
2 Fixture Overlap, 12 Ft. Spacing
2.55 Ft. Light Source Mtg. Ht., 1248 lm

1 fc .5 fc .2 fc .1 fc

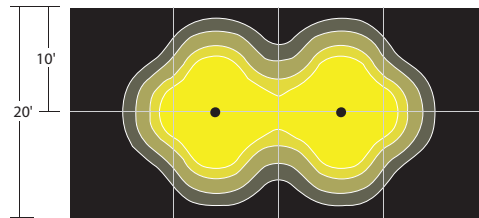

4 sides open

LCS TABLE

BUG RATING	B1-U1-G0	
	Lumens	Lumens %
FRONT		
Low (0°-30°)	309.0	20.6%
Medium (30°-60°)	386.2	25.8%
High (60°-80°)	49.5	3.3%
Very High (80°-90°)	2.3	0.2%
BACK		
Low (0°-30°)	310.9	20.8%
Medium (30°-60°)	388.1	25.9%
High (60°-80°)	48.3	3.2%
Very High (80°-90°)	0.9	0.1%
UPLIGHT		
Low (90°-100°)	1.5	0.1%
High (100°-180°)	0.0	0.0%

LCS GRAPH

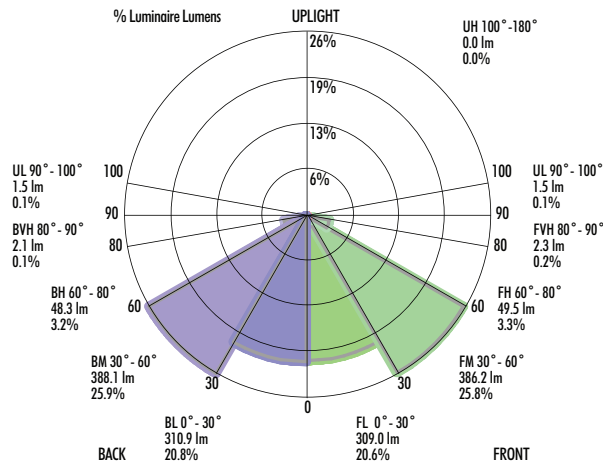

*Lumens delivered

BL2QZ-31/40: LUMENPOLE SQUARE BOLLARD

6" OPEN FRAME - 31", AND 40" HEIGHT
650LM / 1400LM (8W / 18W)

PHOTOMETRY (Continued)

BL2QZ-31B-L14-SYM-W-T30-C90/2-90 (786lm*, 18W, Symmetric Wide, 2 Adjacent Sides Closed, 3000K)

System Power: 18.0 W
Test Date: 09/2023
Beam Angle 50%: 84.0°
Field Angle 10%: 114.5°
Color Temperature: 3987K
CRI: 94.2
Lumens Delivered: 1468
Power Factor: 0.99

MULTIPLIERS	
LUMEN PACKAGE	
-L05	0.46
-L07	0.57
-L10	0.78
-L14	1.00
CCT	
2700K :	0.91
3000K :	0.94
3500K :	0.97
4000K :	1.00
5000K :	1.04
OPTIONS	
-FR :	0.80

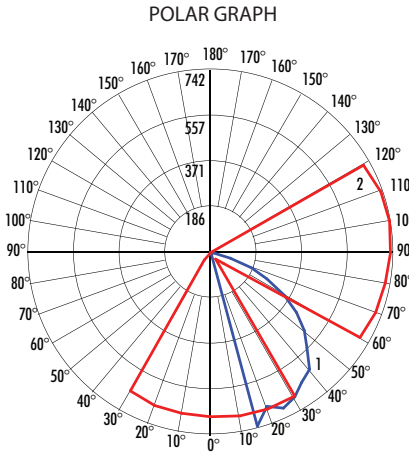

Maximum Candela = 742 Located At Horizontal Angle = 10, Vertical Angle = 15
1 - Vertical Plane Through Horizontal Angles (10 - 190) (Through Max. Cd.)
2 - Horizontal Cone Through Vertical Angle (15) (Through Max. Cd.)

FOOTCANDLES ON GROUND
2.55 Ft. Light Source Mtg. Ht., 403lm

1 fc .5 fc .2 fc .1 fc

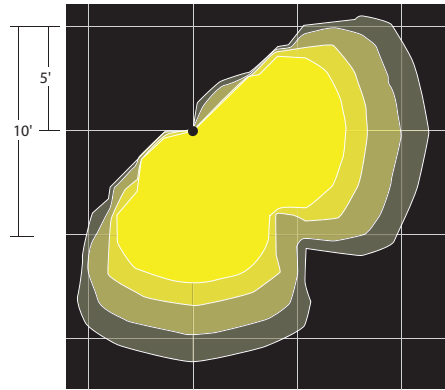

LCS TABLE

BUG RATING	B0-U0-G0	
	Lumens	Lumens %
FRONT		
Low (0-30°)	0.0	17.5%
Medium (30°-60°)	360.7	44.2%
High (60°-80°)	103.6	12.7%
Very High (80°-90°)	2.7	0.3%
BACK		
Low (0-30°)	0.0	5.9%
Medium (30°-60°)	121.4	14.9%
High (60°-80°)	34.4	4.2%
Very High (80°-90°)	0.9	0.1%
UPLIGHT		
Low (90°-100°)	0.0	0.0%
High (100°-180°)	0.0	0.0%

LCS GRAPH

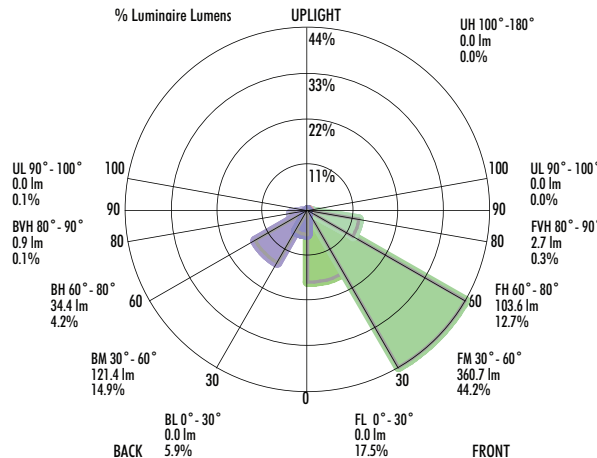

*Lumens delivered

BL2QZ-31/40: LUMENPOLE SQUARE BOLLARD

6" OPEN FRAME - 31", AND 40" HEIGHT
650LM / 1400LM (8W / 18W)

PHOTOMETRY (Continued)

BL2QZ-31B-L14-SYM-W-T30-C90/2-180 (765lm*, 18W, Symmetric Wide, 2 Opposing Sides Closed, 3000K)

System Power: 18.0 W
Test Date: 09/2023
Beam Angle 50%: 84.0°
Field Angle 10%: 114.5°
Color Temperature: 3987K
CRI: 94.2
Lumens Delivered: 1468
Power Factor: 0.99

MULTIPLIERS	
LUMEN PACKAGE	
-L05	0.46
-L07	0.57
-L10	0.78
-L14	1.00
CCT	
2700K :	0.91
3000K :	0.94
4000K :	1.00
5000K :	1.04
OPTIONS	
-FR :	0.80

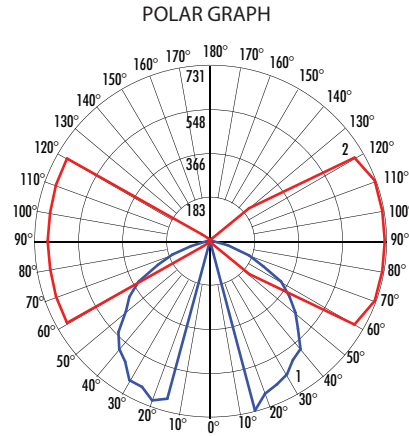

Maximum Candela = 731 Located At Horizontal Angle = 20, Vertical Angle = 15
1 - Vertical Plane Through Horizontal Angles (20 - 200) (Through Max. Cd.)
2 - Horizontal Cone Through Vertical Angle (15) (Through Max. Cd.)

FOOTCANDLES ON GROUND
2 Fixture in line, 16 Ft. spacing and
2 Fixture parallel, 8 Ft. spacing.
2.55 Ft. Light Source Mtg. Ht., 403lm

1 fc ■ .5 fc ■ .2 fc ■ .1 fc

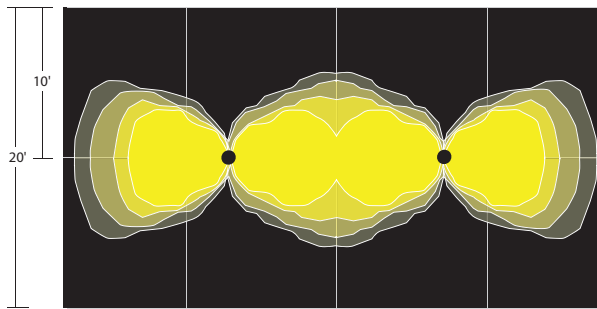

/2-180 in line
2 opposing sides
closed

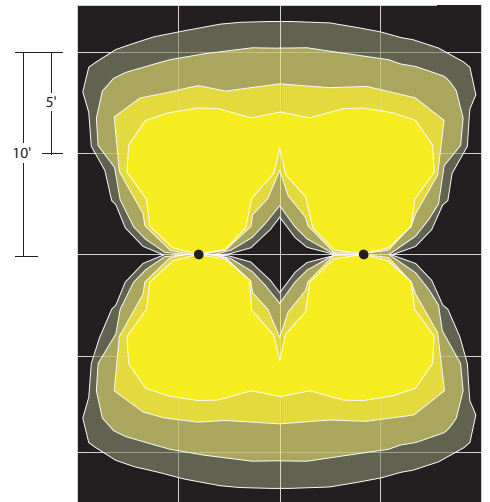

/2-180 parallel
2 opposing sides
closed

LCS TABLE

BUG RATING	B1-U0-G0	
	Lumens	Lumens %
FRONT		
Low (0-30°)	0.0	12.2%
Medium (30°-60°)	237.5	29.5%
High (60°-80°)	69.7	8.6%
Very High (80°-90°)	1.6	0.2%
BACK		
Low (0-30°)	0.0	11.8%
Medium (30°-60°)	235.5	29.2%
High (60°-80°)	67.2	8.3%
Very High (80°-90°)	1.5	0.2%
UPLIGHT		
Low (90°-100°)	0.0	0.0%
High (100°-180°)	0.0	0.0%

LCS GRAPH

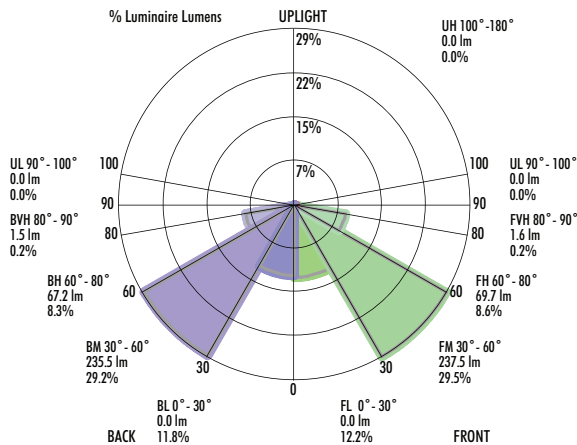

*Lumens delivered

PHOTOMETRY (Continued)

BL2QZ-31B-L14-SYM-W-T30-C90/3-90 (403lm*, 18W, Symmetric Wide, 3-Sides Closed, 3000K)

System Power: 18.0 W
Test Date: 09/2023
Beam Angle 50%: 84.0°
Field Angle 10%: 114.5°
Color Temperature: 3987K
CRI: 94.2
Lumens Delivered: 1468
Power Factor: 0.99

MULTIPLIERS	
LUMEN PACKAGE	
-L05	0.46
-L07	0.57
-L10	0.78
-L14	1.00
CCT	
2700K :	0.91
3000K :	0.94
4000K :	1.00
5000K :	1.04
OPTIONS	
-FR :	0.80

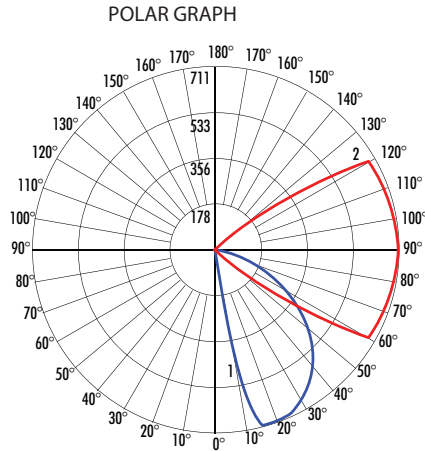

Maximum Candela = 711 Located At Horizontal Angle = 0, Vertical Angle = 20
1 - Vertical Plane Through Horizontal Angles (0 - 180) (Through Max. Cd.)
2 - Horizontal Cone Through Vertical Angle (20) (Through Max. Cd.)

FOOTCANDLES ON GROUND
2 Fixture Overlap, 16 Ft. Spacing
2.55 Ft. Light Source Mtg. Ht., 403lm

1 fc .5 fc .2 fc .1 fc

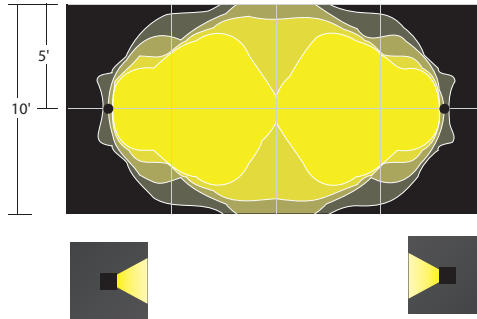

/3-90
3 sides closed

LCS TABLE

BUG RATING	B0-U0-G0	
	Lumens	Lumens %
FRONT		
Low (0-30°)	0.0	25.4%
Medium (30°-60°)	231.3	57.7%
High (60°-80°)	64.3	16.1%
Very High (80°-90°)	2.3	0.6%
BACK		
Low (0-30°)	0.0	0.0%
Medium (30°-60°)	0.1	0.0%
High (60°-80°)	0.5	0.1%
Very High (80°-90°)	0.4	0.1%
UPLIGHT		
Low (90°-100°)	0.0	0.0%
High (100°-180°)	0.0	0.0%

LCS GRAPH

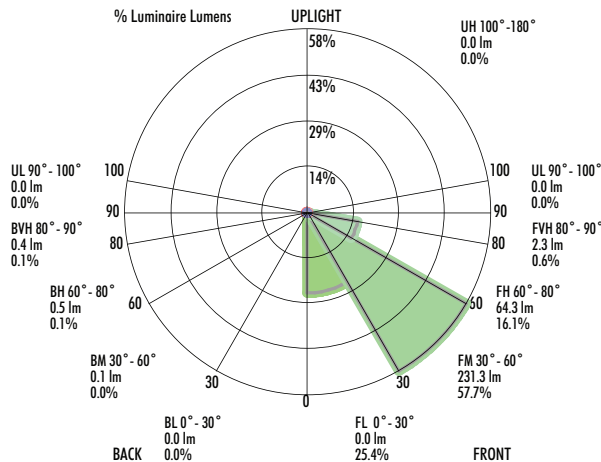

*Lumens delivered

PHOTOMETRY (Continued)

BL2QZ-40B-L14-ASY-FT-T40-C90 (40" Height, 1300lm*, 18W, Asymmetric Wide, 3000K)

System Power: 18.6 W
Test Date: 09/2023
Beam Angle 50%: 62.8°
Field Angle 10%: 95.8°
Color Temperature: 3987K
CRI: 94.2
Lumens Delivered: 1364
Power Factor: 0.99

MULTIPLIERS	
HEIGHT	
-L05	0.42
-L07	0.50
-L10	0.75
-L14	1.00
CCT	
2700K :	0.94
3000K :	1.00
3500K :	1.03
4000K :	1.07

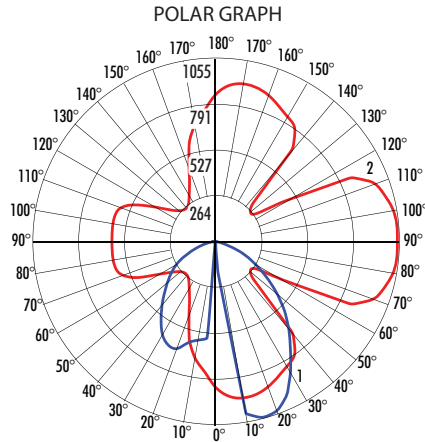

Maximum Candela = 1054.5 Located At Horizontal Angle = 5, Vertical Angle = 15
1 - Vertical Plane Through Horizontal Angles (5 - 185) (Through Max. Cd.)
2 - Horizontal Cone Through Vertical Angle (15) (Through Max. Cd.)

FOOTCANDLES ON GROUND
2 Fixture Overlap, 16 Ft. Spacing
3.1 Ft. Light Source Mtg. Ht., 403lm

1 fc .5 fc .2 fc .1 fc

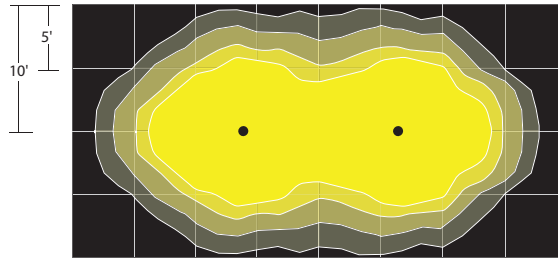

LCS TABLE

BUG RATING	B1-U1-G0	
	Lumens	Lumens %
FRONT		
Low (0-30°)	282.4	22.6%
Medium (30°-60°)	418.7	31.5%
High (60°-80°)	66.5	5.0%
Very High (80°-90°)	2.3	0.2%
BACK		
Low (0-30°)	190.1	14.3%
Medium (30°-60°)	293.9	22.1%
High (60°-80°)	61.7	4.6%
Very High (80°-90°)	2.5	0.2%
UPLIGHT		
Low (90°-100°)	1.6	0.1%
High (100°-180°)	0.0	0.0%

LCS GRAPH

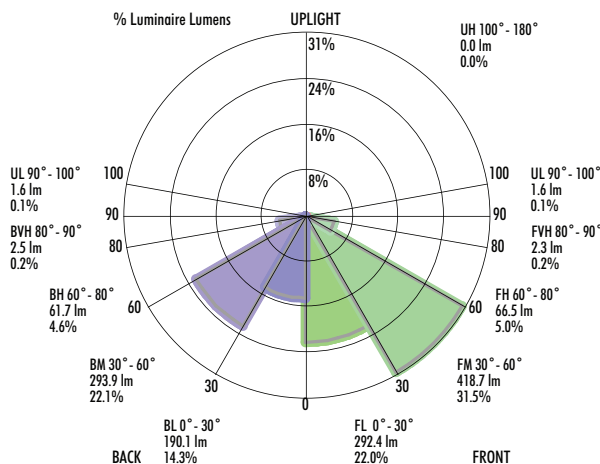

*Lumens delivered

PHOTOMETRY (Continued)

BL2QZ-40B-L14-ASY-FT-T40-C90 (40" Height, 1300lm*, 18W, Asymmetric Wide, 3000K)

System Power: 18.6 W
Test Date: 09/2023
Beam Angle 50%: 86.0°
Field Angle 10%: 123.8°
Color Temperature: 3987K
CRI: 94.2
Lumens Delivered: 1398
Power Factor: 0.99

MULTIPLIERS	
LUMEN PACKAGE	
-L05	0.46
-L07	0.57
-L10	0.78
-L14	1.00
CCT	
2700K :	0.91
3000K :	0.94
4000K :	1.00
5000K :	1.04
OPTIONS	
-FR :	0.80

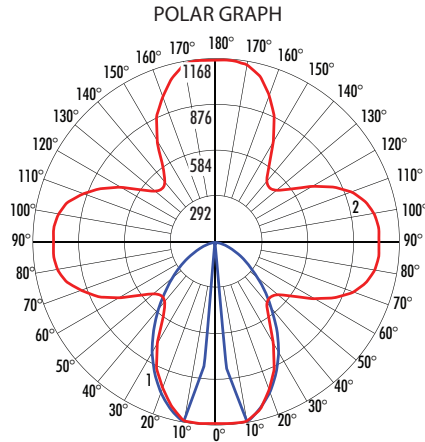

FOOTCANDLES ON GROUND
2 Fixture Overlap, 16 Ft. Spacing
3.1 Ft. Light Source Mtg. Ht., 403lm

1 fc .5 fc .2 fc .1 fc

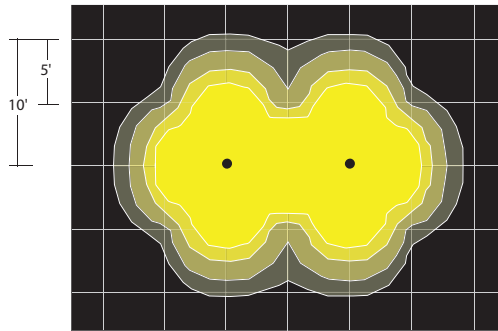

LCS TABLE

BUG RATING	B1-U1-G0	
	Lumens	Lumens %
FRONT		
Low (0-30°)	272.2	21.7%
Medium (30°-60°)	304.4	24.3%
High (60°-80°)	47.5	3.8%
Very High (80°-90°)	1.8	0.1%
BACK		
Low (0-30°)	270.0	21.5%
Medium (30°-60°)	306.2	24.4%
High (60°-80°)	49.2	3.9%
Very High (80°-90°)	1.8	0.1%
UPLIGHT		
Low (90°-100°)	1.3	0.1%
High (100°-180°)	0.0	0.0%

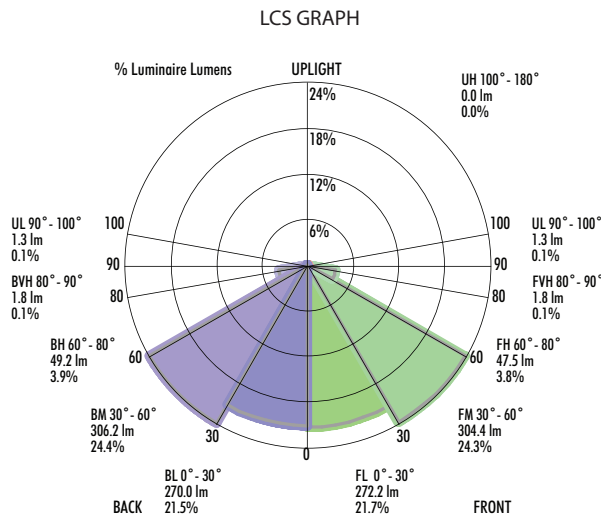

*Lumens delivered

PHOTOMETRY (Continued)

BL2QZ-40B-L14-SYM-N-T40-C90 (40" Height, 1300lm*, 18W, Symmetric Narrow, 3000K)

System Power: 18.6 W
Test Date: 09/2023
Beam Angle 50%: 75.2°
Field Angle 10%: 114.2°
Color Temperature: 3987K
CRI: 94.2
Lumens Delivered: 1306
Power Factor: 0.99

MULTIPLIERS	
LUMEN PACKAGE	
-L05	0.46
-L07	0.57
-L10	0.78
-L14	1.00
CCT	
2700K :	0.91
3000K :	0.94
3500K :	0.97
4000K :	1.00
5000K :	1.04
OPTIONS	
-FR :	0.80

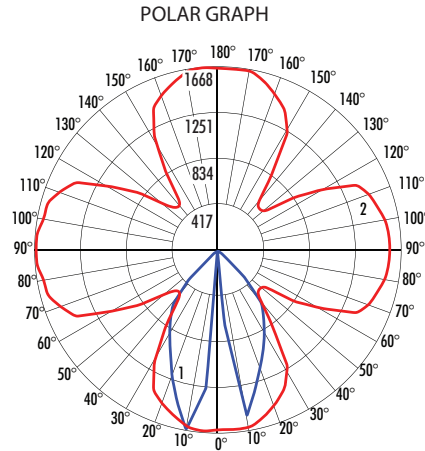

FOOTCANDLES ON GROUND
2 Fixture Overlap, 16 Ft. Spacing
3.1 Ft. Light Source Mtg. Ht., 403lm

1 fc ■ .5 fc ■ .2 fc ■ .1 fc

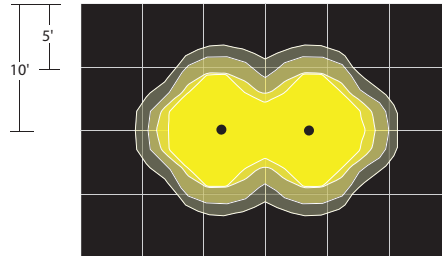

LCS TABLE

BUG RATING	B1-U1-G0	
	Lumens	Lumens %
FRONT		
Low (0-30°)	373.6	26.9%
Medium (30°-60°)	301.7	21.7%
High (60°-80°)	9.5	0.7%
Very High (80°-90°)	0.8	0.1%
BACK		
Low (0-30°)	387.2	27.9%
Medium (30°-60°)	305.6	22.0%
High (60°-80°)	8.3	0.6%
Very High (80°-90°)	0.8	0.1%
UPLIGHT		
Low (90°-100°)	0.9	0.1%
High (100°-180°)	0.0	0.0%

LCS GRAPH

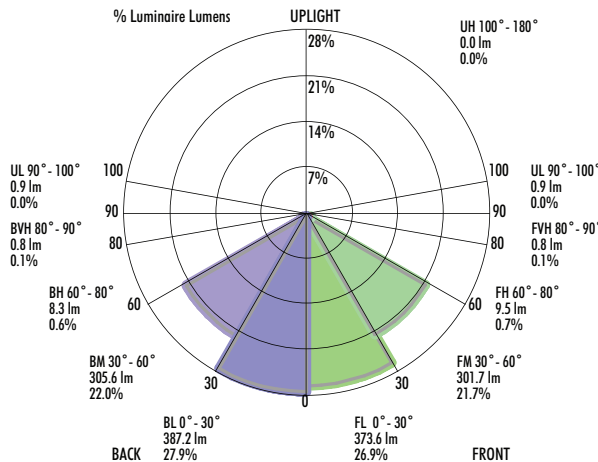

*Lumens delivered

PHOTOMETRY (Continued)

BL2QZ-40B-L14-SYM-W-T40-C90 (40" Height, 1300lm*, 18W, Symmetric Wide, 3000K)

System Power: 18.6 W
Test Date: 09/2023
Beam Angle 50%: 79.3°
Field Angle 10%: 133.3°
Color Temperature: 3987K
CRI: 94.2
Lumens Delivered: 1232
Power Factor: 0.99

MULTIPLIERS	
LUMEN PACKAGE	
-L05	0.46
-L07	0.57
-L10	0.78
-L14	1.00
CCT	
2700K :	0.91
3000K :	0.94
3500K :	0.97
4000K :	1.00
5000K :	1.04
OPTIONS	
-FR :	0.80

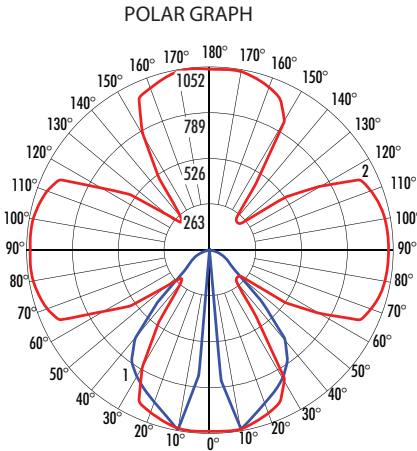

FOOTCANDLES ON GROUND
2 Fixture Overlap, 16 Ft. Spacing
3.1 Ft. Light Source Mtg. Ht., 403lm

1 fc .5 fc .2 fc .1 fc

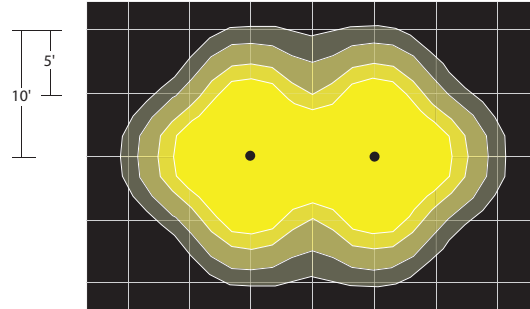

LCS TABLE

BUG RATING	B0-U1-G0	
	Lumens	Lumens %
FRONT	Low (0-30°)	293.6 20.6%
	Medium (30°-60°)	366.9 25.8%
	High (60°-80°)	47.0 3.3%
	Very High (80°-90°)	2.2 0.2%
BACK	Low (0-30°)	295.4 20.8%
	Medium (30°-60°)	368.7 25.9%
	High (60°-80°)	45.9 3.2%
	Very High (80°-90°)	2.0 0.1%
UPLIGHT	Low (90°-100°)	1.4 0.1%
	High (100°-180°)	0.0 0.0%

LCS GRAPH

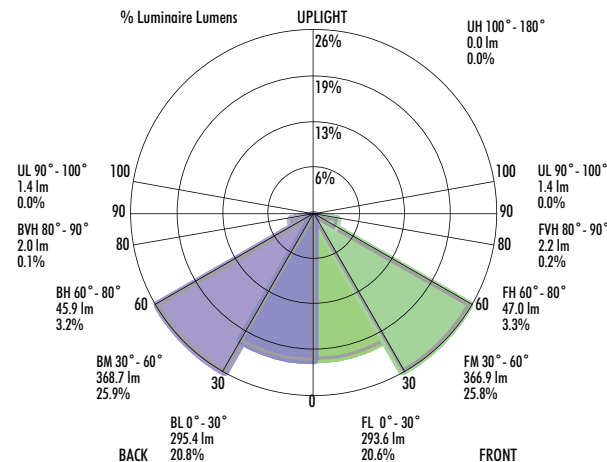

*Lumens delivered