

SPECIFICATION

Application

Architectural/Commercial-grade recessed (COB) Chip on Board Beam Control LED allows for concentrated high center beam candlepower. Twist and lock beam control optic is designed for easy field replacement of 20°, 30°, 40°, 60° and 75° beam spread options.

Mounting

Housing suitable for new construction installations only, supplied with (2) 24" adjustable hanger bars with 90° repositioning ability. Suitable for wood & metal joist support systems, and also drywall & T-bar ceilings. Hanger bars equipped with nail-less install 3/4" serrated barbed studs and captive nails, for faster and easier secure mounting in wood joists. Set-screws lock into position and prevent shifting after installation. Earthquake structural cable compatible for drop panel ceiling or any other mounting that requires direct support from structural ceilings.

Color Temperature (CCT)

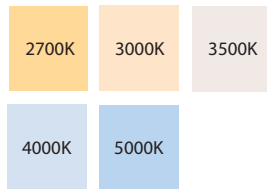

Available in 2700K, 3000K, 3500K, 4000K, 90 CRI; 5000K 80 CRI; 2700K and 3000K, 97 CRI. Binned with 2-step MacAdam Ellipses.

COLOR TEMP:	2700K	3000K	3500K	4000K	5000K
CRI:	90, 97	90, 97	90	90	80

Insulation Contact

(CH6CIC10), (CH6CIC15), and (CH6CIC20) are inherently thermally protected for direct insulation contact without the need for an enclosure. (CH6CIC30) are Non-IC rated housing and must be kept 3" from loose-fill insulation.

Power Connection

Our LED lamp array is replaceable via our on board quick disconnect terminal. Meets CA Title 24 Requirements and other standards restricting the use of Medium Base or Bi-Pin Sockets.

Thermal Management

Heat dissipation facilitated by a large exposed integral aluminum heat sink to maximize heat dissipation in an open-air environment. IC Option thermally engineered to ensure stated L70 LED life without the need for external box. The recommended ambient temperature should be below 35°C (95°F) to achieve a minimum L70 life of 50,000 hours according to the LM80 standard.

Optics

Multifaceted aluminum reflectors produces low glare illumination with multiple light control options.

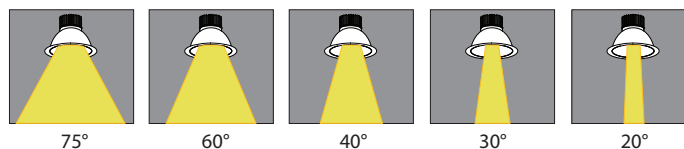

SPECIFICATION (Continued)

Reflector

Field adjustable twist and lock reflector is easily removable to provide quick access to LED lamp array. Frosted polycarbonate lens pre-installed on reflector unifies diode sources and protects diodes from dust and particles from front of aperture. Optional reflector (-EMA) features integral EM switch for 10W emergency backup (UE-D10-EM).

Reflector Finish

The 1-piece, self-flanged, LED design provides a clean trim finish without a secondary trim ring. Heavy gauge aluminum reflector prevents ugly dents during shipping & installation. Deeply mounted singular LED provides 50° visual cutoff. Available in Satin Haze Reflector/White Finish, White Reflector/White Finish, All Black, Clear Specular Reflector/White Finish, and All Satin Haze.

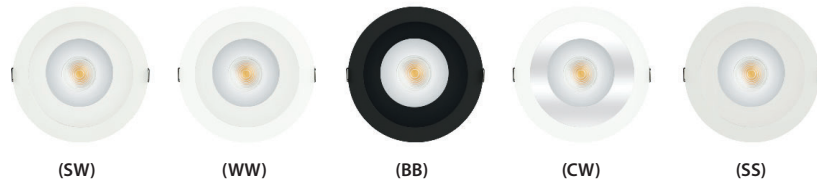

Junction Box

16-gauge pre-wired galvanized steel Junction Box, 26 cubic-inch for a maximum of (8) #12 AWG wires. Furnished with (7) 1/2" knockouts. Strain clamps are included to install or remove covers for an easily accessed ground wire. (-CHP) option is Chicago Plenum, air-tight Junction Box.

Certifications and Listings



cETLus listed to UL1598 and UL8750. Suitable for dry locations only. NYC approved: Calendar #41937. Conforms to City of Chicago Environmental Air CCEA-200 with Section 18-27-300.22 and special requirements Section 14-20-210C-4. Assembled in USA.

Caution

LITON recommends use of surge protectors on the power entering LED Housings. Surge damage is not covered by warranty. (+1KV). Fixtures must be grounded in accordance with national, state and/or local electrical codes. Failure to do so may result in serious personal injury.

SPECIFICATION (Continued)

Control Options

ELV and TRIAC Driver 120V (-DIN):

Compatible with electronic low voltage, and 2-Wire incandescent dimmers. Also known as leading edge, Reverse Phase, Forward Phase dimming. Allows smooth dimming down to 5% depending upon the dimmer's limitations.

0-10V Driver 120V/277V (UE-D10):

Compatible with most existing 0-10V systems. Also known as fluorescent or 5-Wire dimming. Allows smooth dimming down to 5% depending upon the dimmer's limitations. Compatible with daylight harvesting controls.

UniDim™ Driver 120V/277V (UE-DUN):

All in one ELV and TRIAC phase dimming (120V only), and 0-10V dimming (120V/277V). Works with most 3-Wire ELV, 2-Wire incandescent and 120V/277V 5-Wire 0-10V fluorescent dimmers.

Incandescent/Phase Wiring
ELV

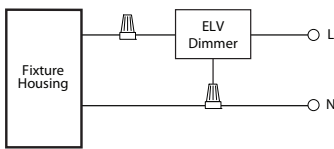

TRIAC

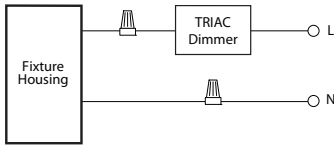

0 - 10V Wiring

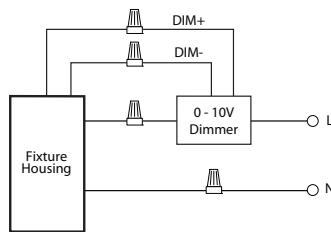

Incandescent/Phase Wiring
ELV

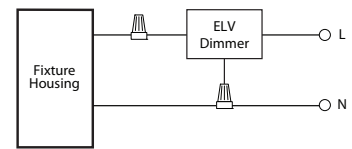

TRIAC

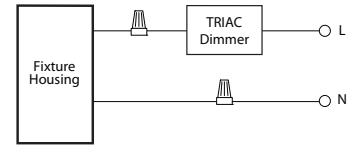

0 - 10V Wiring

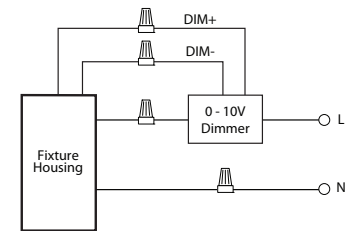

Unisense™ PROGRAMMABLE MOTION + DAYLIGHT (-SUN-RMT, -SUN-RMT-1227)

- Microwave and PIR (Passive Infrared) sensors depending on option
- Daylight harvesting
- Dusk/dawn sensing capabilities
- Motion Sensor

13' Height

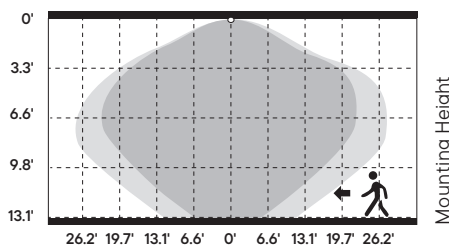

13.1 ft max. distance with 100% sensitivity

50' Height

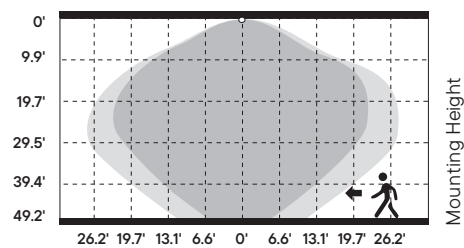

49.2 ft max. distance with 100% sensitivity



SPECIFICATION (Continued)

Warranty

Covered by a 5-Year Warranty to be free of defects in materials and craftsmanship. Recommended for applications where ambient temperatures do not exceed 35°C (95°F), installations exceeding this temperature will result in reduced LED lamp life and a voided warranty.

Emergency Options

Emergency LED Battery Back-up available, remotely mounted adjacently by the installer. When AC power fails, the device immediately switches to the emergency mode, operating the LEDs for a minimum of 90 minutes. Remote test switch and plate cover included. Optional Generator Transfer Device switches the driver to auxiliary generator power during the loss of normal AC power, (recommended for applications requiring individual circuit switching).

EMERGENCY BATTERY (-EM): 10W

- Must be installed in Dry Locations
- 10W constant output to LED lamp

Not rated for outdoor mounting. Damp location rated.

-EM Lumen Data (Battery)

Fixture/Trim	CH6CIC10/CR6LC40
Fixture Wattage:	10W
Fixture Lumens:	1000
Multiplier:	1
EM Lumens:	1000

Fixture/Trim	CH6CIC15/CR6LC40
Fixture Wattage:	15W
Fixture Lumens:	1500
Multiplier:	0.67
EM Lumens:	1000

Fixture/Trim	CH6CIC20/CR6LC40
Fixture Wattage:	20W
Fixture Lumens:	2100
Multiplier:	0.5
EM Lumens:	1050

Fixture/Trim	CH6CIC30/CR6LC40
Fixture Wattage:	30W
Fixture Lumens:	2800
Multiplier:	0.33
EM Lumens:	920

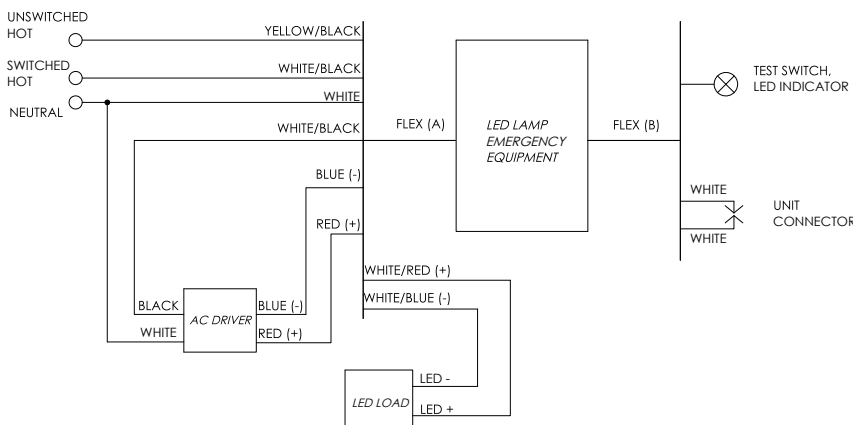

Input Voltage:	120-277VAC/60Hz
Output Voltage:	10W
Wattage:	10W
Switching Time:	<1s
Charging Time:	24h
Operating Time:	90 minutes
Minimum Temperature:	0°C
Maximum Temperature:	50°C
Self-Diagnostic:	No

SPECIFICATION (Continued)

FULL POWER EMERGENCY INVERTER (-EMAC or -EMAC347): 10W - 30W

- Must be installed in Dry Locations
- Wattage package will determine battery sent; corresponding wiring diagrams below
- 170 VDC output to AC DRIVER during EM mode

Not rated for outdoor mounting. Damp location rated.

-EMAC Lumen Data (Battery)

Fixture/Trim	CH6CIC10/CR6LC40
Fixture Wattage:	10W
Fixture Lumens:	1000
EM Lumens:	1000

Fixture/Trim	CH6CIC15/CR6LC40
Fixture Wattage:	15W
Fixture Lumens:	1500
EM Lumens:	1500

Fixture/Trim	CH6CIC20/CR6LC40
Fixture Wattage:	20W
Fixture Lumens:	2100
EM Lumens:	2100

Fixture/Trim	CH6CIC30/CR6LC40
Fixture Wattage:	30W
Fixture Lumens:	2800
EM Lumens:	2800

<25W LOAD

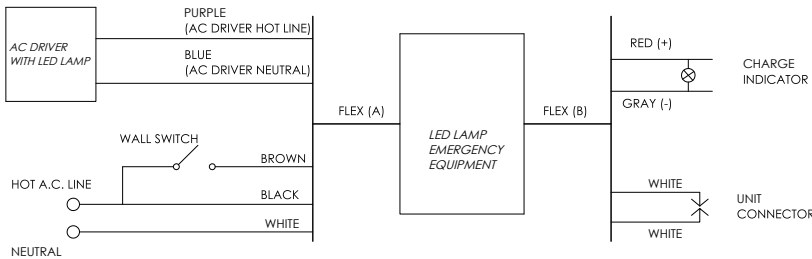

Input Voltage:	120-277VAC/60Hz
Output Voltage:	170VDC (120VAC Equivalent)
Wattage:	25W
Switching Time:	<1s
Charging Time:	24h
Operating Time:	90 minutes
Minimum Temperature:	0°C
Maximum Temperature:	50°C
Self-Diagnostic:	No

<40W LOAD

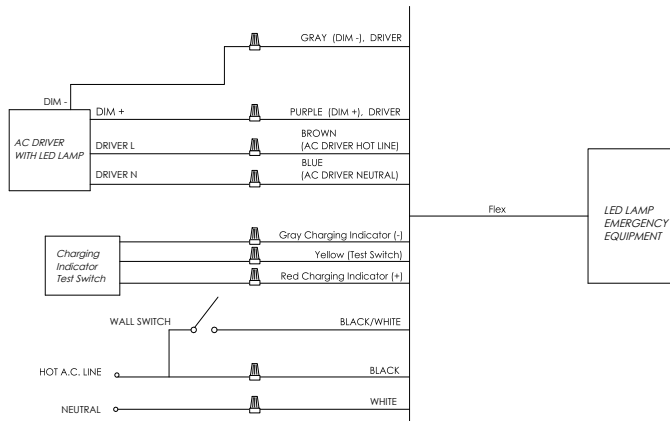

Input Voltage:	120-277VAC or 347VAC/60Hz
Output Voltage:	170VDC (120VAC Equivalent)
Wattage:	30W
Switching Time:	<1s
Charging Time:	24h
Operating Time:	90 minutes
Minimum Temperature:	0°C
Maximum Temperature:	50°C
Self-Diagnostic:	Yes

PHOTOMETRY

CH6CIC30UE-D10_CR6LC40SW-B20-T35 (2800lm, 30W, 20°, 3500K)

System Power:	28.2W	MULTIPLIERS
Test Date:	10/2023	REFLECTOR FINISH
Beam Angle 50%:	23.9°	CW : 1.01
Field Angle 10%:	79.8°	SS : 0.99
Color Temperature:	3408K	SW : 1.00
CRI:	94.3	WW : 0.968
Lumens Delivered:	2610	CCT
CBCP:	6133.7	2700K : 0.91
Power Factor:	0.99	3000K : 0.97
		3500K : 1.00
		4000K : 1.04
		Lumens
		1000lm: 0.39
		1500lm: 0.53
		2100lm: 0.74
		2800lm: 1.00

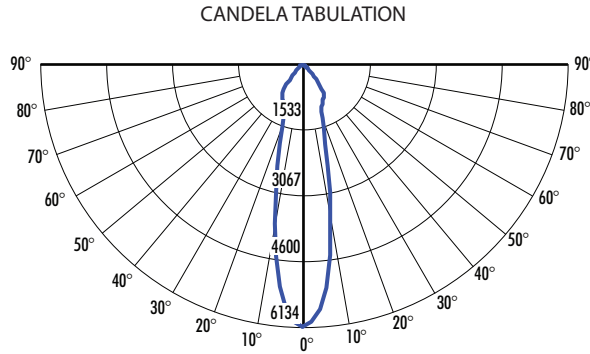

FOOTCANDLE DISTRIBUTION		
Height	Beam Diameter	FC
8.0'	3.39'	95.84
10.0'	4.23'	61.34
12.0'	5.08'	42.60
14.0'	5.93'	31.29
16.0'	6.77'	23.96

CH6CIC30UE-D10_CR6LC40SW-B30-T35 (2800lm, 30W, 30°, 3500K)

System Power:	27.9W	MULTIPLIERS
Test Date:	10/2023	REFLECTOR FINISH
Beam Angle 50%:	34.1°	CW : 1.01
Field Angle 10%:	83.4°	SS : 0.99
Color Temperature:	3378K	SW : 1.00
CRI:	94.5	WW : 0.968
Lumens Delivered:	2656	CCT
CBCP:	4571.5	2700K : 0.91
Power Factor:	0.99	3000K : 0.97
		3500K : 1.00
		4000K : 1.04
		Lumens
		1000lm: 0.39
		1500lm: 0.53
		2100lm: 0.74
		2800lm: 1.00

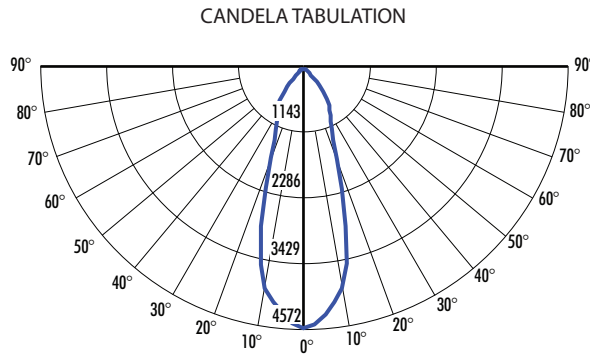

FOOTCANDLE DISTRIBUTION		
Height	Beam Diameter	FC
8.0'	4.91'	71.43
10.0'	6.13'	45.72
12.0'	7.36'	31.75
14.0'	8.59'	23.32
16.0'	9.81'	17.86

CH6CIC30UE-D10_CR6LC40SW-B40-T35 (2800lm, 30W, 40°, 3500K)

System Power:	27.8W	MULTIPLIERS
Test Date:	10/2023	REFLECTOR FINISH
Beam Angle 50%:	40.2°	CW : 1.01
Field Angle 10%:	86.5°	SS : 0.99
Color Temperature:	3262K	SW : 1.00
CRI:	94.1	WW : 0.968
Lumens Delivered:	2139	CCT
CBCP:	3117.6	2700K : 0.91
Power Factor:	0.99	3000K : 0.97
		3500K : 1.00
		4000K : 1.04
		Lumens
		1000lm: 0.39
		1500lm: 0.53
		2100lm: 0.74
		2800lm: 1.00

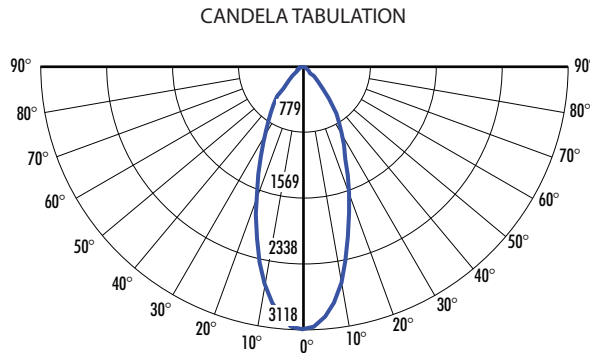

FOOTCANDLE DISTRIBUTION		
Height	Beam Diameter	FC
8.0'	5.86'	48.71
10.0'	7.32'	31.18
12.0'	8.78'	21.65
14.0'	10.25'	15.91
16.0'	11.71'	12.18

CH6CIC30UE-D10_CR6LC40SW-B60-T35 (2800lm, 30W, 60°, 3500K)

System Power:	27.7W	MULTIPLIERS
Test Date:	10/2023	REFLECTOR FINISH
Beam Angle 50%:	64.3°	CW : 1.01
Field Angle 10%:	92.8°	SS : 0.99
Color Temperature:	3297K	SW : 1.00
CRI:	94.1	WW : 0.968
Lumens Delivered:	2648	CCT
CBCP:	2368.1	2700K : 0.91
Power Factor:	0.99	3000K : 0.97
		3500K : 1.00
		4000K : 1.04
		Lumens
		1000lm: 0.39
		1500lm: 0.53
		2100lm: 0.74
		2800lm: 1.00

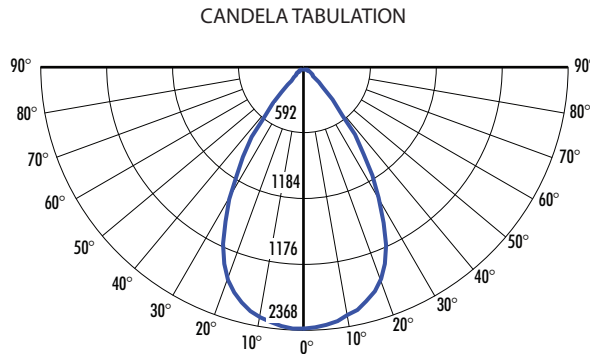

FOOTCANDLE DISTRIBUTION		
Height	Beam Diameter	FC
8.0'	10.06'	37.00
10.0'	12.57'	23.68
12.0'	15.08'	16.44
14.0'	17.60'	12.08
16.0'	20.11'	9.25

2024.05.01

PHOTOMETRY (Continued)

CH6CIC30UE-D10_CR6LC40SW-B75-T35 (2800lm, 30W, 75°, 3500K)

System Power:	27.7W	MULTIPLIERS
Test Date:	10/2023	REFLECTOR FINISH
Beam Angle 50%:	71.7°	CW : 1.01
Field Angle 10%:	92.9°	SS : 0.99
Color Temperature:	3346K	SW : 1.00
CRI:	94.3	WW : 0.968
Lumens Delivered:	2807	CCT
CBCP:	2268.5	2700K : 0.91
Power Factor:	0.99	3000K : 0.97
		3500K : 1.00
		4000K : 1.04
		Lumens
		1000lm: 0.39
		1500lm: 0.53
		2100lm: 0.74
		2800lm: 1.00

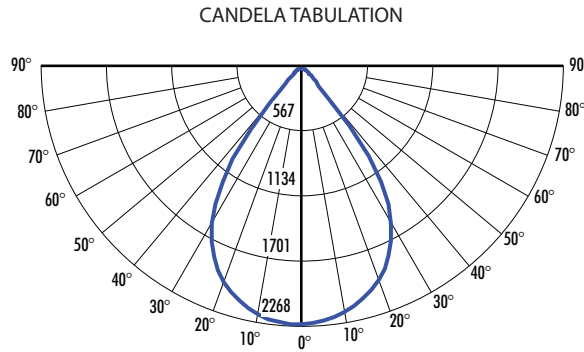

FOOTCANDLE DISTRIBUTION		
Height	Beam Diameter	FC
8.0'	11.43'	35.44
10.0'	14.29'	22.68
12.0'	17.15'	15.75
14.0'	20.01'	11.57
16.0'	22.87'	8.86

2024.05.01