

## CRTR4LC : 4" C-SERIES

(COB) CHIP ON BOARD BEAM CONTROL LED, RETROFIT/REMODEL  
 1000LM - 2500LM (10W-30W)

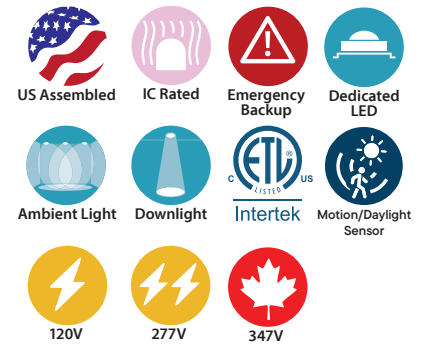

- Heavy-duty seamless die-cast reflector
- Assortment of dimming options
- COB LED design for concentrated high CBCP beam
- Multiple beam spreads for flexible beam control
- Twist and lock reflector for quick access to LED lamp array

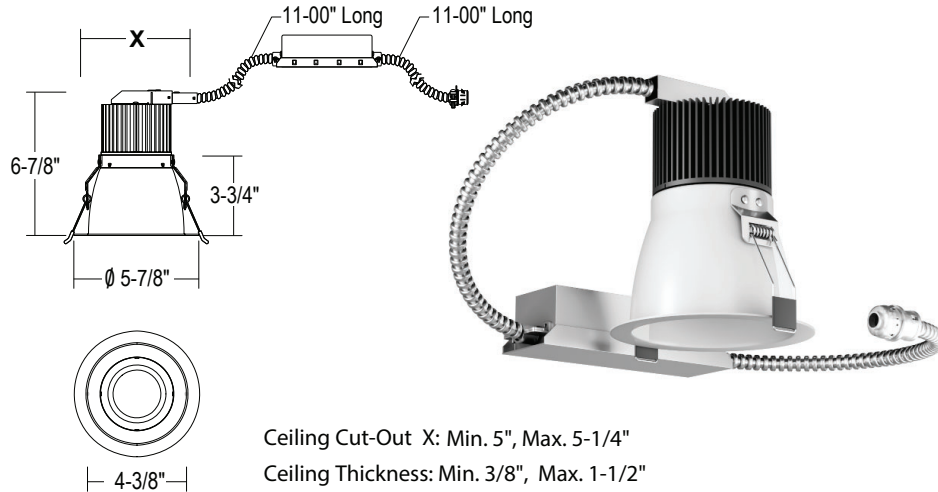

### ORDERING : CRTR4LC10SW-B30-T27UE-D10-JB-CHP

CRTR4LC		Insulation Contact	Reflector Finish	Beam Spread	CCT	Control	Emergency Options	J-Box	Options
Fixture/Lumens									
1000lm (10W)	<b>CRTR4LC10</b>		20° Spot	<b>-B20</b>	0-10V Dimming	<b>UE-D10</b>	None		<b>Blank</b>
1400lm (15W)	<b>CRTR4LC15</b>		30° Narrow Flood	<b>-B30</b>	UniDim™ 0-10V, TRIAC/ELV Dimming	<b>UE-DUN</b>	10W Emergency Battery		<b>-EM</b>
1900lm (20W)	<b>CRTR4LC19</b>		50° Wide Flood	<b>-B50</b>	TRIAC/ELV Dimming (120V)	<b>-DIN</b>	Full Power Emergency Inverter		<b>-EMAC<sup>6</sup></b>
2500lm (30W)	<b>CRTR4LC25</b>		60° Very Wide Flood	<b>-B60</b>	Lutron Hi-Lume	<b>UE-DHL</b>	Full Power Emergency Inverter (347V)		<b>-EMAC347<sup>6</sup></b>
			70° Very Wide Flood	<b>-B70</b>	0-10V Dimming (347V)	<b>-347-D10<sup>2</sup></b>	GTD Device		<b>-GTD</b>
Insulation Contact			CCT					J-Box	
Non-IC	<b>Blank</b>		2700K (90 CRI)	<b>-T27</b>	1%, 0-10V Dimming	<b>UE-D10P1</b>		None	<b>Blank</b>
ICA Rated	<b>ICA<sup>4</sup></b>		2700K (97 CRI)	<b>-T27-C97</b>	0-10V Dimming with 10W Integral Emergency Battery Backup	<b>UE-D10-EMA<sup>5</sup></b>			<b>-JB</b>
Airtight			3000K (90 CRI)	<b>-T30</b>	DMX Dimming with input via XLR5 (120V/277V)	<b>UE-DMXLR5</b>		None	<b>-JB-CHP</b>
Reflector Finish			3000K (97 CRI)	<b>-T30-C97</b>	DMX Dimming with input via RJ45 (120V/277V)	<b>UE-DMXRJ45</b>		Junction Box (Chicago Plenum)	
Satin Haze Reflector/ White Ring	<b>SW</b>		3500K (90 CRI)	<b>-T35</b>	0%, DMX Dimming	<b>-DMX</b>			
White Reflector/ White Ring	<b>WW</b>		4000K (90 CRI)	<b>-T40</b>	Athena Wireless Node (120V)	<b>-AWN</b>		Options	
All Black	<b>BB</b>		5000K (80 CRI)	<b>-T50</b>	Athena Wireless Node	<b>-AWN-OCC</b>		None	<b>Blank</b>
Clear Specular Reflector/White Ring	<b>CW<sup>3</sup></b>				Occupancy Sensor (120V)	<b>-SUN-RMT<sup>8</sup></b>		4.5" Ceiling Thickness	<b>-CT4</b>
All Satin Haze	<b>SS</b>				UniSense - Remotely Mounted Motion/Photosensor (120V)	<b>-SUN-RMT-1227<sup>8</sup></b>			
					UniSense - Remotely Mounted Motion/Photosensor	<b>-DCSM<sup>7</sup></b>			
					Casambi Wireless Dimming	<b>-DBNT<sup>7</sup></b>			
					BubblyNet Wireless System	<b>-VIVE<sup>7</sup></b>			
					Lutron Vive Wireless Dimming Module				

<sup>1</sup> All drivers are 120V/277V unless otherwise noted.  
<sup>2</sup> -347-D10 is not available for CRTR4LC10.  
<sup>3</sup> Clear finish reflector not recommended for placing close to vertical surfaces. Uneven striations may be visible.  
<sup>4</sup> (ICA) is only available for CRTR4LC10, CRTR4LC15, and CRTR4LC19. (CRTR4LC25 are Non-IC rated.)  
<sup>5</sup> UE-D10-EMA is not compatible with -EM or -EMAC or -EMAC347 or -GTD  
<sup>6</sup> Check Wiring Diagrams.  
<sup>7</sup> Special Order.  
<sup>8</sup> (-SUN-RMT) sensor sent with mounting clips for existing ceiling applications.

### COMPATABILITY

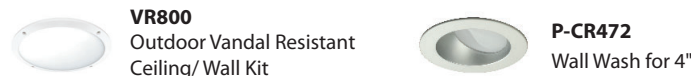

## SPECIFICATION

### Application

Architectural/Commercial-grade recessed (COB) Chip on Board Beam Control LED allows for concentrated high center beam candlepower. Twist and lock TIR beam control optic is designed for easy field replacement of 20°, 30°, 50°, 60°, and 70° beam spread options.

### Retrofit Mounting

Designed for use with existing 4" Architectural, Incandescent, Fluorescent, and Metal Halide Housings. Supplied with flexible metal conduit for connection to existing electrical junction box. Uses existing frame-in-kits mounting method via clips. Consult factory for special mounting methods.

Use the -JB Junction box option for remodel applications that don't have an existing housing frame or an electrical junction box close by. The retaining spring clips option allows for mounting to wood or gypsum board ceilings without the need of a frame.

### Color Temperature (CCT)

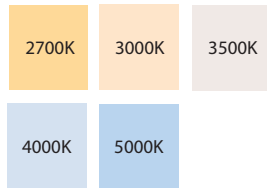

Available in 2700K, 3000K, 3500K, 4000K, 90 CRI; 5000K 80 CRI; 2700K and 3000K, 97 CRI.

Binned with 2-step MacAdam Ellipses.

COLOR TEMP:	2700K	3000K	3500K	4000K	5000K
CRI:	90, 97	90, 97	90	90	80

### Insulation Contact

(CRTR4LC10), (CRTR4LC15), and (CRTR4LC19) are inherently thermally protected for direct insulation contact without the need for an enclosure. (CRTR4LC25) are Non-IC rated housings and must be kept 3" from loose-fill insulation.

### Power Connection

Our LED lamp array is replaceable via our on board quick disconnect terminal. Meets CA Title 24 Requirements and other standards restricting the use of Medium Base or Bi-Pin Sockets.

### Thermal Management

Heat dissipation facilitated by a large exposed integral aluminum heat sink to maximize heat dissipation in an open-air environment. The recommended ambient temperature should be below 35°C (95°F) to achieve a minimum L70 life of 50,000 hours according to the LM80 standard.

### Optics

Multifaceted aluminum reflectors produces low glare illumination with multiple light control options.

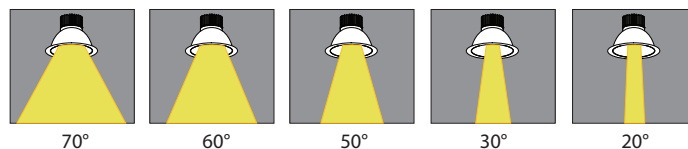

## SPECIFICATION (Continued)

### Reflector

---

Field adjustable twist and lock reflector is easily removable to provide quick access to LED lamp array. Optional reflector (-EMA) features integral EM switch for 10W emergency backup (UE-D10-EMA).

### Reflector Finish

---

The 1-piece, self-flanged, LED design provides a clean trim finish without a secondary trim ring. Heavy gauge aluminum reflector prevents ugly dents during shipping & installation. Deeply mounted singular LED provides 50° visual cutoff. Available in Satin Haze Reflector/White Finish, White Reflector/White Finish, All Black, Clear Specular Reflector/White Finish, and All Satin Haze.

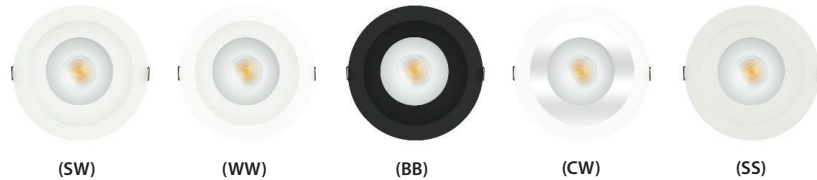

### Junction Box

---

16 gauge pre-wired aluminum Junction Box. 7 cubic-inch for a maximum of (4) #12 AWG wires. (2) 1/2" knock-outs. Remove covers for easy access and ground wire.

### Certifications and Listings

---



cETLus listed to UL1598 and UL8750. Suitable for dry locations only. NYC approved: Calendar #41937. Conforms to City of Chicago Environmental Air CCEA-200 with Section 18-27-300.22 and special requirements Section 14-20-210C-4. Assembled in USA.

### Caution

---

LITON recommends use of surge protectors on the power entering LED Housings. Surge damage is not covered by warranty. (+1KV). Fixtures must be grounded in accordance with national, state and/or local electrical codes. Failure to do so may result in serious personal injury.

## SPECIFICATION (Continued)

### Control Options

#### ELV and TRIAC Driver 120V (-DIN):

Compatible with electronic low voltage, and 2-Wire incandescent dimmers. Also known as leading edge, Reverse Phase, Forward Phase dimming. Allows smooth dimming down to 5% depending upon the dimmer's limitations.

#### 0-10V Driver 120V/277V (UE-D10):

Compatible with most existing 0-10V systems. Also known as fluorescent or 5-Wire dimming. Allows smooth dimming down to 5% depending upon the dimmer's limitations. Compatible with daylight harvesting controls.

#### UniDim™ Driver 120V/277V (UE-DUN):

All in one ELV and TRIAC phase dimming (120V only), and 0-10V dimming (120V/277V). Works with most 3-Wire ELV, 2-Wire incandescent and 120V/277V 5-Wire 0-10V fluorescent dimmers.

Incandescent/Phase Wiring  
ELV

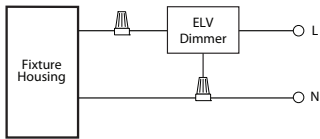

TRIAC

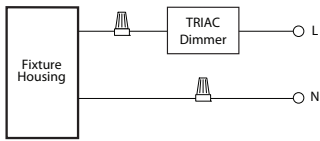

0 - 10V Wiring

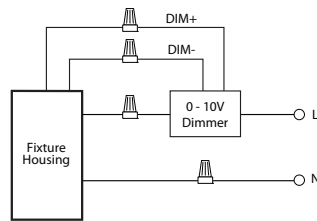

UE-D10-EM Wiring

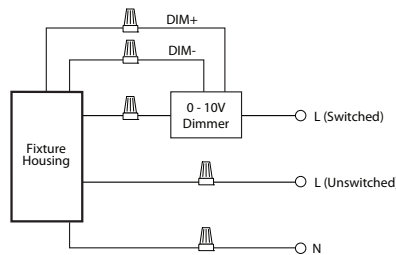

Incandescent/Phase Wiring  
ELV

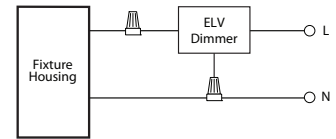

TRIAC

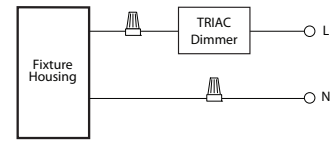

0 - 10V Wiring

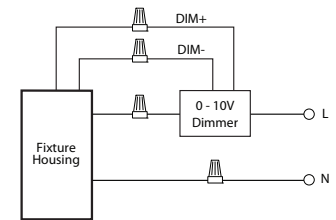

## Unisense™ PROGRAMMABLE MOTION + DAYLIGHT (-SUN-RMT, -SUN-RMT-1227)

- Microwave and PIR (Passive Infrared) sensors depending on option
- Daylight harvesting
- Dusk/dawn sensing capabilities
- Motion Sensor

13' Height

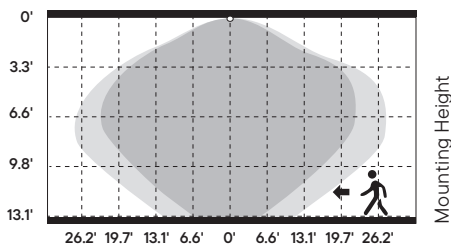

13.1 ft max. distance with 100% sensitivity

50' Height

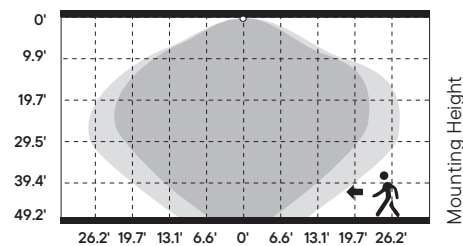

49.2 ft max. distance with 100% sensitivity



Possibly Detected Area



## SPECIFICATION (Continued)

### Warranty

Covered by a 5-Year Warranty to be free of defects in materials and craftsmanship. Recommended for applications where ambient temperatures do not exceed 35°C (95°F), installations exceeding this temperature will result in reduced LED lamp life and a voided warranty.

### Emergency Options

Emergency LED Battery Back-up available, remotely mounted adjacently by the installer. When AC power fails, the device immediately switches to the emergency mode, operating the LEDs for a minimum of 90 minutes. Remote test switch and plate cover included. Optional Generator Transfer Device switches the driver to auxiliary generator power during the loss of normal AC power, (recommended for applications requiring individual circuit switching).

### EMERGENCY BATTERY (UE-D10 -EMA): 10W

- Must be installed in Dry Locations
- 10W constant output to LED lamp

**Not rated for outdoor mounting. Damp location rated.**

#### -EM Lumen Data (Battery)

Fixture/Trim	CRTR4LC10
Fixture Wattage:	10W
Fixture Lumens:	1000
Multiplier:	1
EM Lumens:	1000

Fixture/Trim	CRTR4LC15
Fixture Wattage:	15W
Fixture Lumens:	1400
Multiplier:	0.67
EM Lumens:	940

Fixture/Trim	CRTR4LC19
Fixture Wattage:	20W
Fixture Lumens:	1900
Multiplier:	0.5
EM Lumens:	950

Fixture/Trim	CRTR4LC25
Fixture Wattage:	30W
Fixture Lumens:	2500
Multiplier:	0.33
EM Lumens:	830

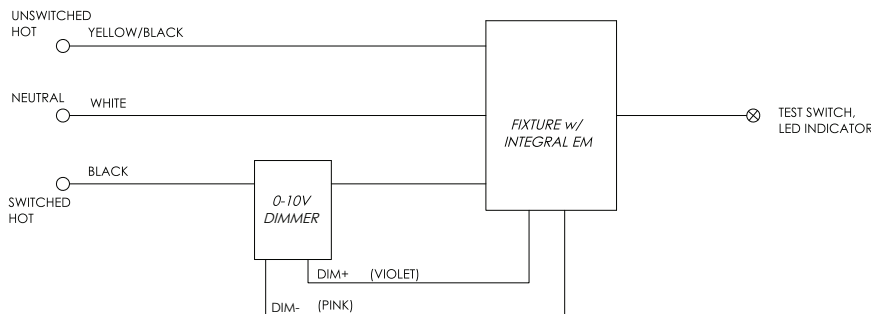

Input Voltage:	120-277VAC/60Hz
Output Voltage:	10W
Wattage:	10W
Switching Time:	<3s
Charging Time:	12h
Operating Time:	90 minutes
Minimum Temperature:	0°C
Maximum Temperature:	48°C
Self-Diagnostic:	Yes

## SPECIFICATION (Continued)

### FULL POWER EMERGENCY INVERTER (-EMAC or -EMAC347): 30W Max

- Must be installed in Dry Locations
- Wattage package will determine battery sent; corresponding wiring diagrams below
- 170 VDC output to AC DRIVER
- during EM mode

**Not rated for outdoor mounting. Damp location rated.**

#### -EMAC Lumen Data (Battery)

Fixture/Trim	CRTR4LC10
Fixture Wattage:	10W
Fixture Lumens:	1000
EM Lumens:	1000

Fixture/Trim	CRTR4LC15
Fixture Wattage:	15W
Fixture Lumens:	1400
EM Lumens:	1400

Fixture/Trim	CRTR4LC19
Fixture Wattage:	20W
Fixture Lumens:	1900
EM Lumens:	1900

Fixture/Trim	CRTR4LC25
Fixture Wattage:	30W
Fixture Lumens:	2500
EM Lumens:	2500

#### <25W LOAD

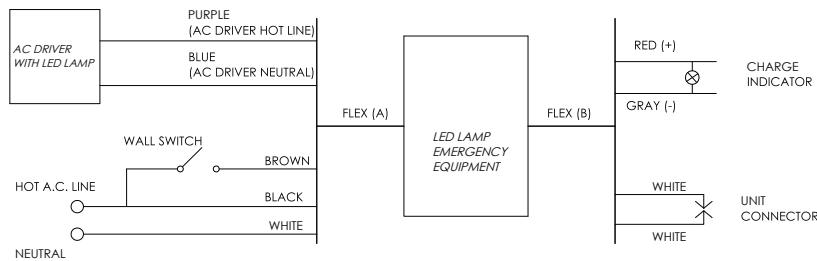

Input Voltage:	120-277VAC/60Hz
Output Voltage:	170VDC (120VAC Equivalent)
Wattage:	25W
Switching Time:	<1s
Charging Time:	24h
Operating Time:	90 minutes
Minimum Temperature:	0°C
Maximum Temperature:	50°C
Self-Diagnostic:	No

#### <40W LOAD

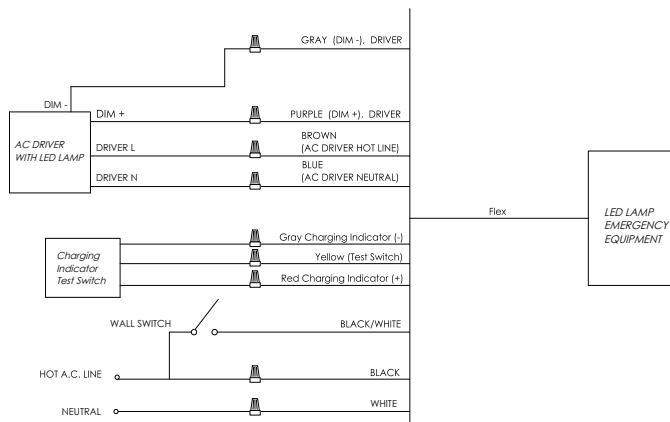

Input Voltage:	120-277VAC or 347VAC/60Hz
Output Voltage:	170VDC (120VAC Equivalent)
Wattage:	30W
Switching Time:	<1s
Charging Time:	24h
Operating Time:	90 minutes
Minimum Temperature:	0°C
Maximum Temperature:	50°C
Self-Diagnostic:	Yes

## PHOTOMETRY

### CRTR4LC25CW-B20-T35UE-D10 (2500lm, 30W, 20°, 3500K)

System Power: 30W  
Test Date: 10/2023  
Beam Angle 50%: 17.3°  
Field Angle 10%: 33.8°  
Color Temperature: 3486K  
CRI: 91.9  
Lumens Delivered: 2337  
CBCP: 11293  
Power Factor: 0.99

MULTIPLIERS	
REFLECTOR FINISH	
CW :	1.00
SS :	0.99
SW :	0.99
WW :	0.96
CCT	
2700K :	0.91
3000K :	0.97
3500K :	1.00
4000K :	1.04
Lumens	
1000lm :	0.45
1400lm :	0.56
1900lm :	0.78
2500lm :	1.00

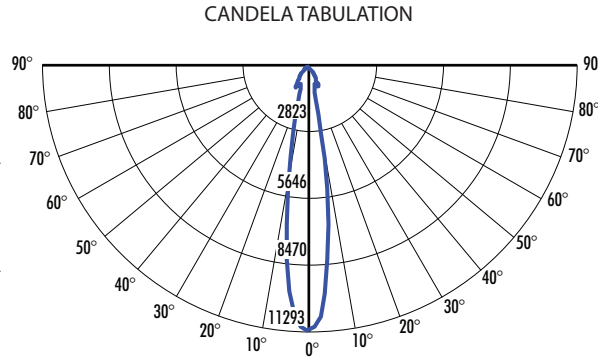

#### FOOTCANDLE DISTRIBUTION

Height	Beam Diameter	FC
8.0'	2.43'	176.45
10.0'	3.04'	112.93
12.0'	3.65'	78.42
14.0'	4.26'	57.62
16.0'	4.87'	44.11

### CRTR4LC25CW-B30-T35UE-D10 (2500lm, 30W, 30°, 3500K)

System Power: 30W  
Test Date: 10/2023  
Beam Angle 50%: 24.1°  
Field Angle 10%: 67.7°  
Color Temperature: 3456K  
CRI: 92.0  
Lumens Delivered: 2326  
CBCP: 7046  
Power Factor: 0.99

MULTIPLIERS	
REFLECTOR FINISH	
CW :	1.00
SS :	0.99
SW :	0.99
WW :	0.96
CCT	
2700K :	0.91
3000K :	0.97
3500K :	1.00
4000K :	1.04
Lumens	
1000lm :	0.45
1400lm :	0.58
1900lm :	0.78
2500lm :	1.00

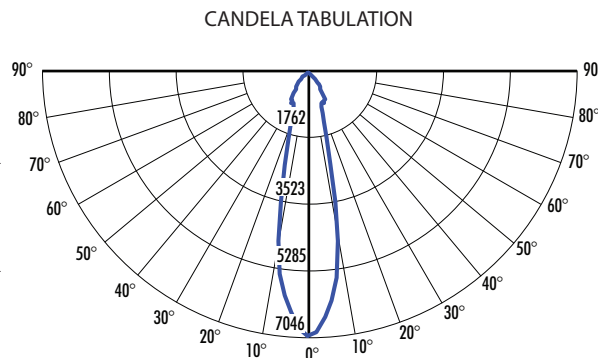

#### FOOTCANDLE DISTRIBUTION

Height	Beam Diameter	FC
8.0'	3.42'	110.10
10.0'	4.27'	70.46
12.0'	5.12'	48.93
14.0'	5.98'	35.95
16.0'	6.83'	27.53

### CRTR4LC25CW-B50-T35UE-D10 (2500lm, 30W, 50°, 3500K)

System Power: 30W  
Test Date: 10/2023  
Beam Angle 50%: 48.8°  
Field Angle 10%: 79.0°  
Color Temperature: 3446K  
CRI: 91.7  
Lumens Delivered: 2547  
CBCP: 3624  
Power Factor: 0.99

MULTIPLIERS	
REFLECTOR FINISH	
CW :	1.00
SS :	0.99
SW :	0.99
WW :	0.96
CCT	
2700K :	0.91
3000K :	0.97
3500K :	1.00
4000K :	1.04
Lumens	
1000lm :	0.42
1400lm :	0.56
1900lm :	0.77
2500lm :	1.00

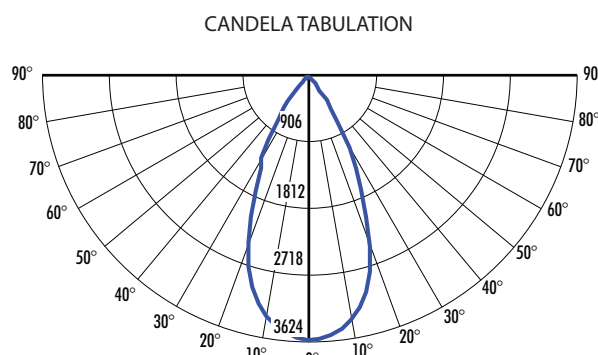

#### FOOTCANDLE DISTRIBUTION

Height	Beam Diameter	FC
8.0'	7.26'	56.62
10.0'	9.07'	36.24
12.0'	10.89'	25.17
14.0'	12.70'	18.49
16.0'	14.52'	14.16

### CRTR4LC25CW-B60-T35UE-D10 (2500lm, 30W, 60°, 3500K)

System Power: 30W  
Test Date: 10/2023  
Beam Angle 50%: 62.6°  
Field Angle 10%: 80.6°  
Color Temperature: 3454K  
CRI: 91.7  
Lumens Delivered: 2553  
CBCP: 2895  
Power Factor: 0.99

MULTIPLIERS	
REFLECTOR FINISH	
CW :	1.00
SS :	0.99
SW :	0.99
WW :	0.96
CCT	
2700K :	0.91
3000K :	0.97
3500K :	1.00
4000K :	1.04
Lumens	
1000lm :	0.42
1400lm :	0.56
1900lm :	0.77
2500lm :	1.00

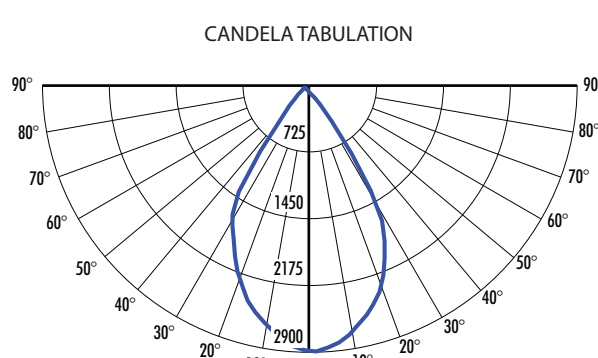

#### FOOTCANDLE DISTRIBUTION

Height	Beam Diameter	FC
8.0'	9.73'	45.19
10.0'	12.16'	28.92
12.0'	14.59'	20.09
14.0'	17.02'	11.30
16.0'	19.46'	8.93

2024.02.02

## PHOTOMETRY (Continued)

### CRTR4LC25WW-B70-T35UE-D10 (2500lm, 30W, 70°, 3500K)

System Power:	30W	MULTIPLIERS
Test Date:	10/2023	REFLECTOR FINISH
Beam Angle 50%:	63.2°	CW : 1.04
Field Angle 10%:	84.1°	SS : 1.03
Color Temperature:	3441K	SW : 1.03
CRI:	91.5	<b>WW : 1.00</b>
Lumens Delivered:	2058	CCT
CBCP:	1830.5	2700K : 0.91
Power Factor:	0.99	3000K : 0.97
		<b>3500K : 1.00</b>
		4000K : 1.04
		Lumens
		1000lm: 0.40
		1400lm: 0.55
		1900lm: 0.79
		<b>2500lm: 1.00</b>

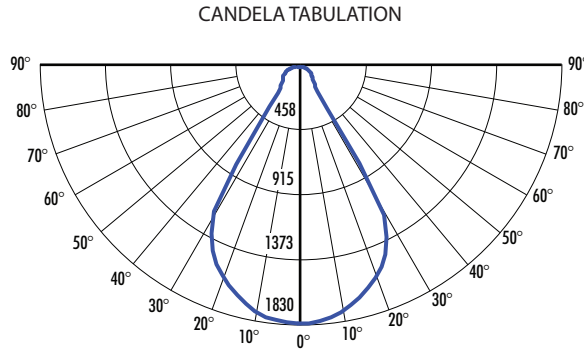

### FOOTCANDLE DISTRIBUTION

Height	Beam Diameter	FC
8.0'	9.84'	28.60
10.0'	12.30'	18.30
12.0'	14.76'	12.71
14.0'	17.23'	9.34
16.0'	19.69'	7.15