

DL36R2 : 6" ROUND VANDAL RESISTANT RECESSED DOWNLIGHT (IP65/IP67) 1000LM-2600LM (10W-30W)

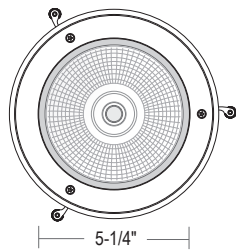
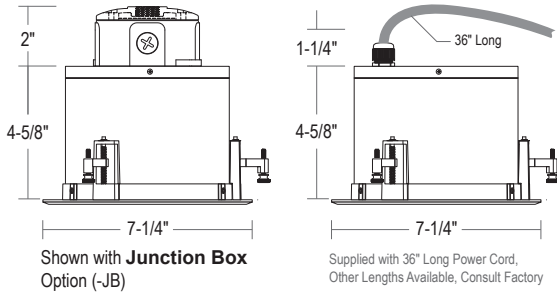

- Intertek
- 120V
- 277V
- 347V
- U.S. Assembled
- Outdoor
- Wet
- Damp Location
- Vandal Resistant
- Emergency Backup
- Cold Weather
- IC Rated
- Marine Grade
- Downlight

- Remote Emergency Available
- IP65 Standard, IP67 Rated Option
- Tamper Resistant Fasteners
- IK08 option available with Polycarbonate Lens
- Multiple Wireless Control Options
- Integral J-Box Option
- Anti-Ligature

ORDERING : DL36R2W-L15-B10-T27

Finish	Lumens	Beam Spread	Control	Color Temperature	Emergency Options	Options
Finish	Lumens	Beam Spread	Control	Color Temperature	Emergency Options	Options
White	DL36R2W		Non-Dimming (120V)	Blank	4000K (90 CRI)	Blank
Silver	DL36R2S²		UniDim (120V/277V)	UE-DUN	2700K (90 CRI)	Hex-Cell Louver -LVR
Bronze	DL36R2BZ²		0-10V (120V/277V)	UE-D10	2700K (97CRI)	Frosted Lens -FR
Black	DL36R2B		Incandescent (120V)	-DIN	3000K (90 CRI)	Cold Weather -CW³
Light Silver	DL36R2LS²		0-10V 1% (120V/277V)	UE-D10P1	3000K (97CRI)	Marine Grade Finish -MGD²
Dark Grey	DL36R2DG²		0-10V (347V)	347-D10⁵	3500K (90 CRI)	IK08 Impact Rated -IK08¹
Metallic Gold	DL36R2MG²		UniSense - Integral Motion/ Photosensor (120V)	SUN-INT^{1,6}	5000K (80 CRI)	Polycarbonate Lens
Metallic Black	DL36R2MB²		UniSense - Integral Motion/ Photosensor (120V/277V)	SUN-INT-1227^{1,6}	RGB+W Control (24VDC)	Integral Junction Box -JB
	Lumens		Casambi Wireless Dimming (120V/277V)	-DCSM¹	590nm Amber (Turtle Safe)	Surge Protector -SRG
	1000lm (10W)		BubblyNet Wireless System (120V/277V)	-DBNT¹	Emergency Inverter	72" Long Power Cord -CRD72
	1500lm (15W)		SimplySnap Wireless System (120V/277V)	-DSYN^{1,6}		IP67 Rated -IP67¹
	2200lm (22W)					
	2600lm (30W)					
	Beam Spread					
	Wide Flood	Blank				
	Narrow Spot	-B10				
	Spot	-B20				
	Flood	-B45				
	Wall Wash Optics	-BWW				
	Asymmetric (30° x 60°)	-B3060¹				

¹ Special order. Minimum Order, Extended lead time may apply. Consult Factory.
² Special Order Finish. Minimum order quantity (MOQ) applies. Orders less than MOQ are subject to a special paint set-up fee for the quantity ordered. Extended lead times may apply. Consult Factory.
³ Starting temperature for -CW option -40°C/-40°F; see pg. 7.
⁴ Remote Power Supplies and Control Gear Required, Available with Wireless Bluetooth or DMX Control. See pg. 4 or consult factory for details.
⁵ Not compatible with 1000lm selection; use with 1500lm and above.
⁶ Must be ordered with (-JB).
⁷ (-EMAC) is not compatible with (-CW) option.

Custom RAL Color: Please note that we appreciate custom finishes. Custom finishes are subject to a special paint setup fee for the quantity ordered. Extended lead times may apply. Consult Factory.

2025.11.19

SPECIFICATION

Application

Architectural-grade recessed LED downlight housing for medium to high ceilings combines energy efficiency with powerful lumen output. Perfect for atriums, churches, lobbies, and airports that have high ceilings.

Housing

Housing is constructed from a round one piece high grade aluminum extrusion. (Alloy 6061 <04% Cu). Faceplate (with a tempered glass lens) and top cap are of a robust die-cast aluminum alloy and seal the housing (top and bottom) using silicone gaskets

Mounting:

Housing suitable for existing or new construction installation. Supplied with screw down mounting clips, designed to secure the fixture to an existing flat surface. Mounting Pan with hanger bars are available. Consult Factory.

Finish:

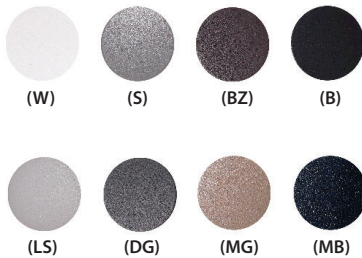

A 7-stage electrostatic, polymer process provides an outdoor textured powder coat finish that delivers outstanding durability, superior anti-aging, resistance to corrosion and UV-degradation. Consult factory for Custom Color. (More Information).

Standard Finishes:

White: RAL 9003 (W)
Silver: RAL 7037 (S)
Bronze: RAL 8019 (BZ)
Black: RAL 9005 (B)

Special Order Finishes:

Light Silver: RAL 7036 (LS)
Dark Gray: RAL 7015 (DG)
Metallic Gold: RAL 1001 (MG)
Metallic Black: RAL 7021 (MB)

Marine Grade:

The fixture features a marine-grade textured powder coat finish engineered to withstand extreme environmental conditions, including prolonged exposure to UV radiation, salt air, and moisture, which are prevalent in coastal and high-humidity environments.

A multi-stage surface preparation, finishing, and curing process ensures maximum adhesion, durability, and corrosion resistance. The coating system undergoes rigorous salt spray (ASTM B117) testing, overbake resistance verification, and pencil hardness testing to validate its robustness against degradation.

The marine-grade powder coat is applied as a 30–50 µm bottom layer, providing a strong anti-corrosion foundation. This is further enhanced by a surface coat using a standard architectural-grade powder application with a total thickness of 80–120 µm, ensuring superior resistance to wear, impact, and environmental stressors.

Certifications and Listings:



ETL / cETL Listed to UL1598 and UL8750 standards.

Suitable wet locations. (IP65 Standard, IP67 Option Available)

Assembled in USA.

IK08 rated for impact resistance..

SPECIFICATION (Continued)

Caution: LITON recommends use of surge protectors on the power entering light fixture.

Warranty

Covered by a 5-Year Warranty to be free of defects in materials and craftsmanship. Fixture should not be installed in applications with ambient temperature above 50°C/122°F. Doing so will result in reduced lamp life and voided warranty.

Optics

Multifaceted aluminum reflector produces low glare illumination with multiple light control options.

Standard Beam:

Used for maximum light output and visible field angle.

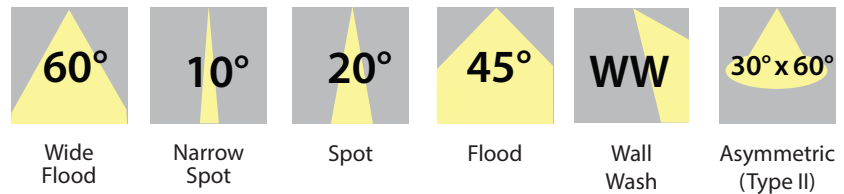

LED

COB (Chip on Board) singular LED light source provides for smooth, uniform light output, eliminating the imaging produced by multiple LED source optics.

Lumen Maintenance:

Lumen Maintenance is a minimum 50,000 hours L70 life based on ANSI TM-21 calculations from LM80 standardized test results.

Lumen Options (Nominal):

1000lm (10W) (Blank)	2200lm (22W) (-L20)
1500lm (15W) (-L15)	2600lm (30W) (-L26)

Color Temperature:

Binned with 4-step MacAdam ellipses as per ANSI Standard recommendation.

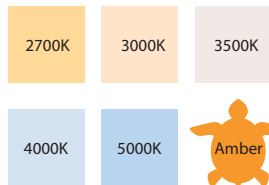

COLOR TEMP:	2700K	3000K	3500K	4000K	5000K
CRI:	90, 97	90, 97	90	90	80

Amber: 590nm (Turtle Safe)

SPECIFICATION (Continued)

RGB+W:



CASAMBI

15W RGBW LED Module Illuminates surfaces up to 10 feet away. Used for applications desiring a dynamic color changing effect. RGB+W design allows fine-tuned pastel colors and saturated hues without sacrificing illumination brightness. Can be set for static colors or dynamic shows. Multiple control options available with either CASAMBI Wireless Bluetooth control or DMX 512 remote mounted decoders.

On-site commissioning and programming available.

Consult Factory for Layout Assistance and Lead Times.

COLOR	CCT/WAVELENGTH	POWER
Red	640nm	3.1W
Green	520nm	3.1W
Blue	450nm	3.1W
White	2700K	3.1W

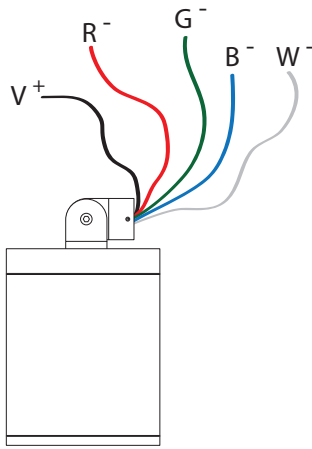

WIRED

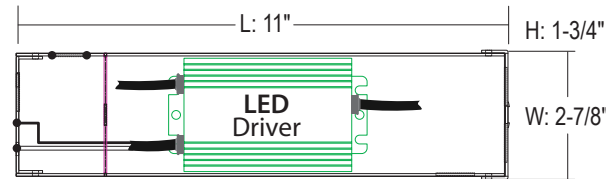

Junction Box Dimensions: 11" x 2-7/8" x 1-3/4" (LxWxH)

Remote Power Supply	Controls	Wattage
LD5-RGBW-RMTJBX	Remote Mounted Decoder -DMX512	15W -W15
	Wireless Bluetooth Control -CASAMBI	30W -W30
		60W -W60
		96W -W96

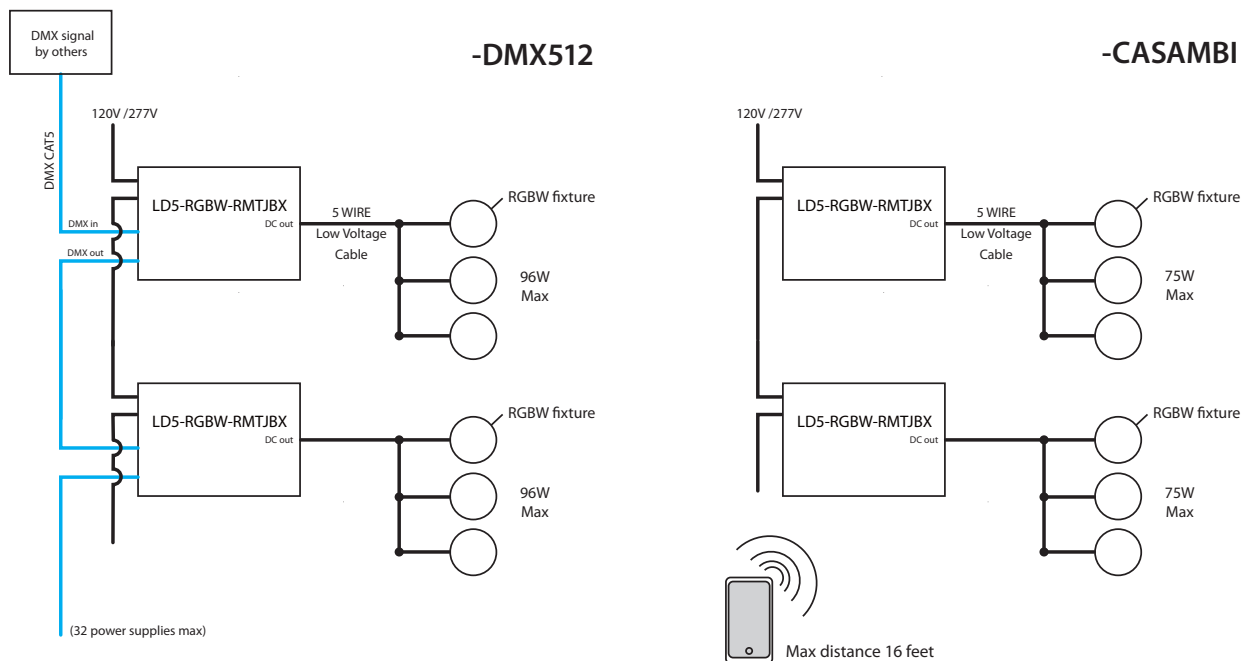

NOTE: Power supply must be placed in dry locations only. 100 feet max for 5 wire low voltage cable 18AWG.

SPECIFICATION (Continued)

Emergency Options

Emergency LED Battery Back-up available, remotely mounted adjacently by the installer. When AC power fails, the device immediately switches to the emergency mode, operating the LEDs for a minimum of 90 minutes. Remote test switch and plate cover included. Optional Generator Transfer Device switches the driver to auxiliary generator power during the loss of normal AC power, (recommended for applications requiring individual circuit switching).

FULL POWER EMERGENCY INVERTER (-EMAC: 10W - 30W)

- Must be installed in Dry Locations
- Wattage package will determine if 25W or 40W battery gets sent; corresponding wiring diagrams below
- 170 VDC output to AC DRIVER during EM mode

Not rated for outdoor mounting. Damp location rated.

-EMAC Lumen Data (Battery)

Fixture/Trim	DL36R2
Fixture Wattage:	10W
Fixture Lumens:	1000lm
EM Lumens:	1000lm

Fixture/Trim	DL36R2-L15
Fixture Wattage:	15W
Fixture Lumens:	1500lm
EM Lumens:	1500lm

Fixture/Trim	DL36R2-L20
Fixture Wattage:	20W
Fixture Lumens:	2200lm
EM Lumens:	2200lm

Fixture/Trim	DL36R2-L26
Fixture Wattage:	30W
Fixture Lumens:	2600lm
EM Lumens:	2600lm

<25W LOAD

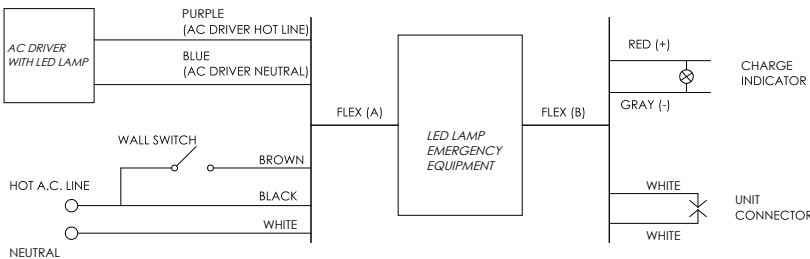

Input Voltage:	120-277VAC/60Hz
Output Voltage:	170VDC (120VAC Equivalent)
Wattage:	25W
Switching Time:	<1s
Charging Time:	24h
Operating Time:	90 minutes
Minimum Temperature:	0°C
Maximum Temperature:	50°C
Self-Diagnostic:	No

<40W LOAD

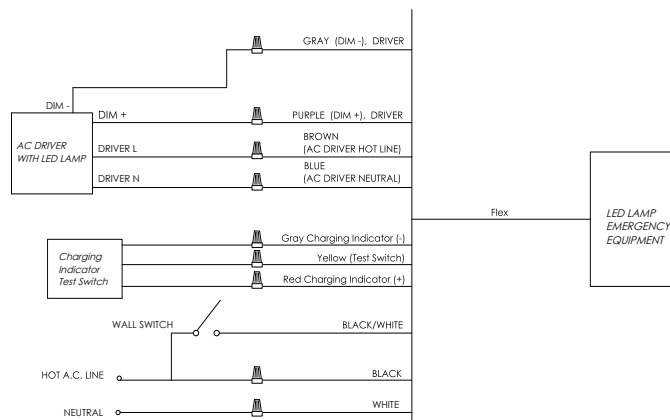

Input Voltage:	120-277VAC or 347VAC/60Hz
Output Voltage:	170VDC (120VAC Equivalent)
Wattage:	40W
Switching Time:	<1s
Charging Time:	24h
Operating Time:	90 minutes
Minimum Temperature:	0°C
Maximum Temperature:	50°C
Self-Diagnostic:	Yes

SPECIFICATION (Continued)

Additional Options

Optional J-Box (Direct Conduit Entry):

For use with mounting locations without a recessed junction box.
Factory installed outlet box with five (5) 1/2 NPSM trade conduit holes and plugs
(1 top, 4 sides) for 1/2 in. trade conduit and wire entry.

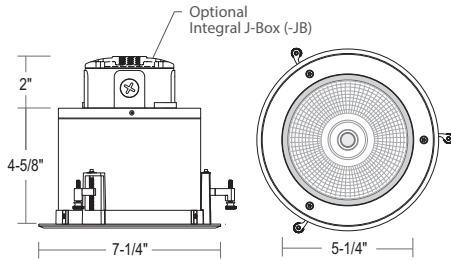

Configure as:

-JB: (5) conduit entry from left or
right looking at fixture

Surge Suppressor (/SRG):

Protects driver against surges in line voltage/current
(20KV, 1.2/50 μ S & 10KA, 8/20 μ S).

Provides a positive indication of end-of-life by opening voltage to the load.

Surge suppressor is a perishable device requiring periodic replacement.

Not a warranted item.



Electrical

LED Driver: AC 50/60Hz Electronic Direct Current Class 2 driver integrally mounted.
Power Factor > 0.90. See Dimming Section for voltage and wiring.

Minimum Operating Temperature:

Standard: -10°C/14°F

Cold Weather Option: (-CW) -40°C/-40°F

SPECIFICATION (Continued)

Control Options

ELV and TRIAC Driver 120V (-DIN):

Compatible with electronic low voltage, and 2-Wire incandescent dimmers. Also known as leading edge, Reverse Phase, Forward Phase dimming. Allows smooth dimming down to 5% depending upon the dimmer's limitations.

0-10V Driver 120V/277V (UE-D10):

Compatible with most existing 0-10V systems. Also known as fluorescent or 5-Wire dimming. Allows smooth dimming down to 5% depending upon the dimmer's limitations. Compatible with daylight harvesting controls.

UniDim™ Driver 120V/277V (UE-DUN):

All in one ELV and TRIAC phase dimming (120V only), and 0-10V dimming (120V/277V). Works with most 3-Wire ELV, 2-Wire incandescent and 120V/277V 5-Wire 0-10V fluorescent dimmers.

Incandescent/Phase Wiring
ELV

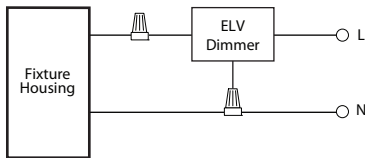

TRIAC

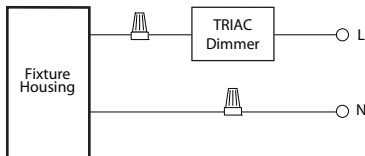

0 - 10V Wiring

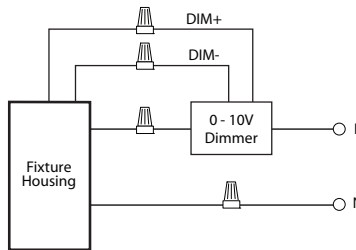

Incandescent/Phase Wiring
ELV

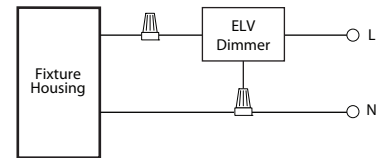

TRIAC

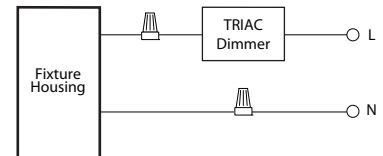

0 - 10V Wiring

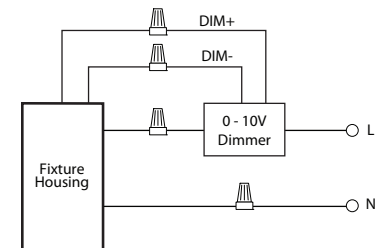

SPECIFICATION (Continued)

Unisense[™] PROGRAMMABLE MOTION + DAYLIGHT (-SUN-INT, -SUN-INT-1227)

- Microwave and PIR (Passive Infrared) sensors depending on option
- Daylight harvesting
- Dusk/dawn sensing capabilities
- Motion Sensor

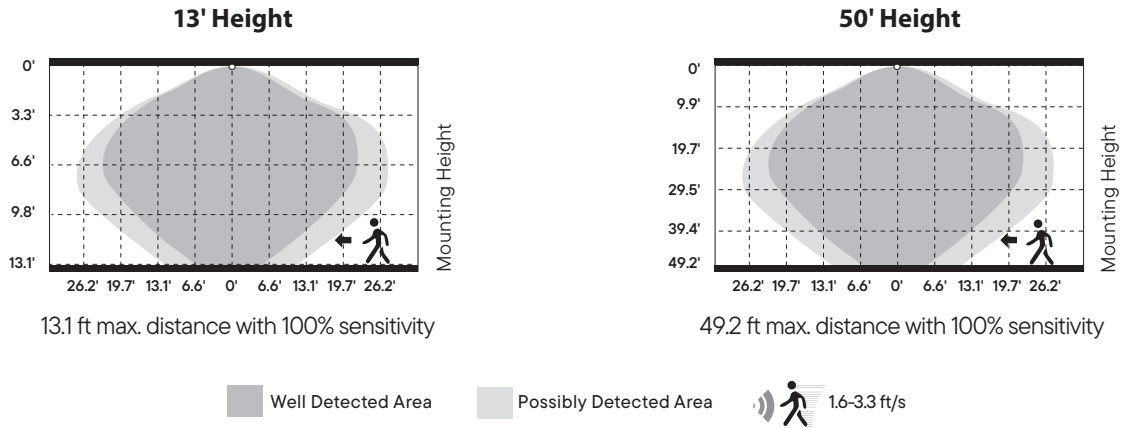

PHOTOMETRY – DL36R2 (L26)

Footcandle Distribution Cone Charts

STANDARD BEAM – WIDE FLOOD (Blank)

Height	Beam Diameter	Footcandle (FC)*
6.0'	10.0'	37.4
8.0'	13.3'	21.1
10.0'	16.6'	13.5
12.0'	19.9'	9.4
14.0'	23.2'	6.9

*at center of beam

STANDARD BEAM – NARROW SPOT (-B10)

Height	Beam Diameter	Footcandle (FC)*
6.0'	1.9'	245.2
10.0'	3.1'	88.3
14.0'	4.4'	45.0
18.0'	5.7'	27.2
20.0'	6.3'	22.1

*at center of beam

STANDARD BEAM – SPOT (-B20)

Height	Beam Diameter	Footcandle (FC)*
6.0'	2.0'	216.0
8.0'	2.6'	121.5
10.0'	3.3'	77.8
12.0'	3.9'	54.0
14.0'	4.6'	39.7

*at center of beam

STANDARD BEAM – FLOOD (-B45)

Height	Beam Diameter	Footcandle (FC)*
6.0'	3.8'	105.1
8.0'	5.1'	59.1
10.0'	6.3'	37.8
12.0'	7.6'	26.3
14.0'	8.9'	19.3

*at center of beam

Footcandles On Ground (2 - Fixture Overlap)

5.0 fc 2.0 fc 1.0 fc .5 fc

STANDARD BEAM – WIDE FLOOD (Blank)
8' Mounting

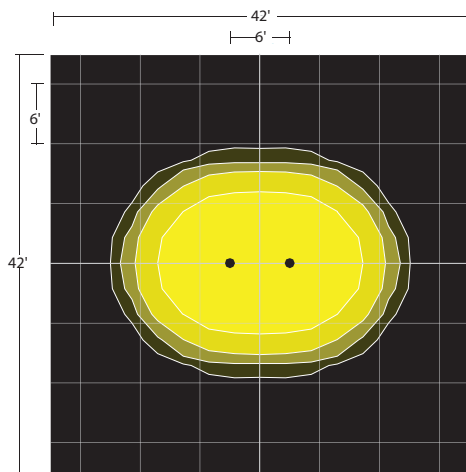

STANDARD BEAM – WIDE FLOOD
16' Mounting

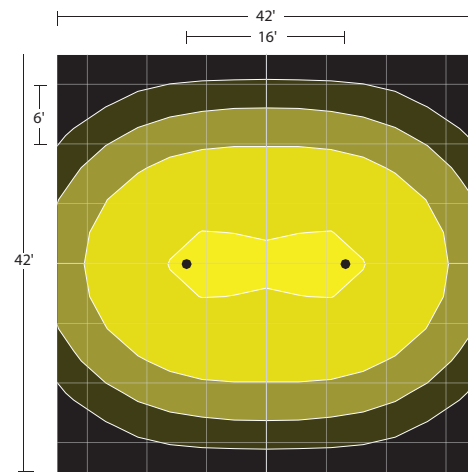

SPECIALTY BEAM – TYPE IV (-BIV)
8' Mounting

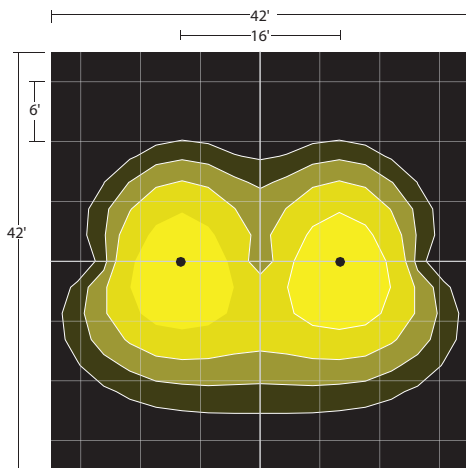

SPECIALTY BEAM – TYPE IV (-BIV)
16' Mounting

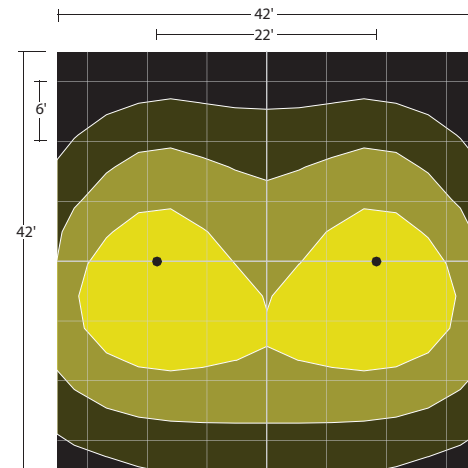

2023.07.17

PHOTOMETRY – DL36R2 (L26) (Cont.)

Footcandles On Ground (2 - Fixture Overlap)

5.0 fc 2.0 fc 1.0 fc .5 fc

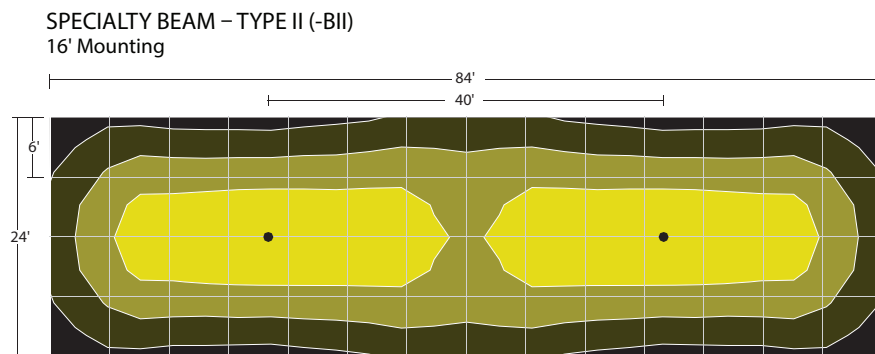
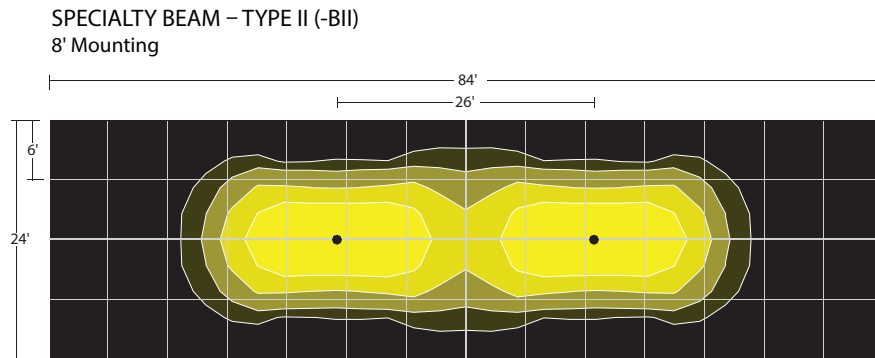

LUMEN OUTPUT / LPW /BUG RATING

LM	W	Beam Spread	-T27 (2700K, 90 CRI)					-T30 (3000K, 90 CRI)					-T35 (3500K, 90 CRI)					Blank (4000K, 90 CRI)					-T50 (5000K, 80 CRI)									
			LM	LPW	cd	B	U	G	LM	L/W	cd	B	U	G	LM	LPW	cd	B	U	G	LM	LPW	cd	B	U	G	LM	LPW	cd	B	U	G
1000 lm	14.3	Wide Flood	959	67	728	1	0	0	998	70	758	1	0	0	1012	71	769	1	0	0	1014	71	770	1	0	0	1208	84	918	1	0	0
		-B02	317	22	612	1	0	0	330	23	637	1	0	0	334	23	646	1	0	0	335	23	647	1	0	0	399	28	771	1	0	0
		-CB20	284	20	647	1	0	0	295	21	674	1	0	0	300	21	683	1	0	0	300	21	684	1	0	0	358	25	816	1	0	0
		-CB35	448	31	666	1	0	0	466	33	694	1	0	0	472	33	703	1	0	0	473	33	705	1	0	0	564	39	840	1	0	0
		-B10	1134	79	6116	2	0	0	1180	83	6367	2	0	0	1197	84	6456	2	0	0	1199	84	6468	2	0	0	1429	100	7708	2	0	0
		-B20	929	65	5788	2	0	0	968	68	6026	2	0	0	981	69	6110	2	0	0	983	69	6122	2	0	0	1171	82	7295	2	0	0
		-B45	968	68	2351	2	0	0	1008	70	2448	2	0	0	1022	71	2482	2	0	0	1024	72	2487	2	0	0	1220	85	2964	2	0	0
		-BII	951	67	927	1	0	0	990	69	966	1	0	0	1004	70	979	1	0	0	1006	70	981	1	0	0	1199	84	1169	1	0	0
		-BWW	834	58	653	1	0	0	868	61	680	1	0	0	880	62	689	1	0	0	882	62	691	1	0	0	1051	73	823	1	0	0
-BIV	834	58	653	1	0	1	868	61	680	1	0	1	880	62	689	1	0	1	882	62	691	1	0	1	1051	73	823	1	0	1		
-L15 (1500 lm)	13.9	Wide Flood	1296	93	576	1	0	0	1350	97	600	1	0	0	1368	98	608	1	0	0	1371	99	609	1	0	0	1634	118	726	1	0	0
		-B02	403	29	484	1	0	0	419	30	504	1	0	0	425	31	511	1	0	0	426	31	512	1	0	0	507	37	610	1	0	0
		-CB20	361	26	512	1	0	0	375	27	533	1	0	0	381	27	541	1	0	0	381	27	542	1	0	0	454	33	645	1	0	0
		-CB35	569	41	528	1	0	0	593	43	549	1	0	0	601	43	557	1	0	0	602	43	558	1	0	0	717	52	665	1	0	0
		-B10	1237	89	4157	2	0	0	1288	93	4328	2	0	0	1306	94	4389	2	0	0	1309	94	4397	2	0	0	1560	112	5240	2	0	0
		-B20	1316	95	4157	2	0	0	1370	99	4328	2	0	0	1389	100	4389	2	0	0	1392	100	4397	2	0	0	1659	119	5240	2	0	0
		-B45	1303	94	1912	2	0	0	1356	98	1990	2	0	0	1375	99	2018	2	0	0	1378	99	2022	2	0	0	1642	118	2410	2	0	0
		-BII	1241	89	754	1	0	0	1292	93	784	1	0	0	1310	94	795	1	0	0	1313	94	797	1	0	0	1564	113	950	1	0	0
		-BWW	1059	76	517	1	0	0	1103	79	538	1	0	0	1118	80	546	1	0	0	1121	81	547	1	0	0	1333	96	650	1	0	0
-BIV	1059	76	517	1	0	1	1103	79	538	1	0	1	1118	80	546	1	0	1	1121	81	547	1	0	1	1335	96	652	1	0	1		
-L20 (2000 lm)	19.5	Wide Flood	2135	109	816	1	0	0	2223	114	849	1	0	0	2254	116	861	1	0	0	2258	116	863	1	0	0	2691	138	1028	1	0	0
		-B02	654	34	667	1	0	0	681	35	694	1	0	0	690	35	704	1	0	0	691	35	705	1	0	0	824	42	840	1	0	0
		-CB20	585	30	705	1	0	0	609	31	734	1	0	0	618	32	744	1	0	0	619	32	746	1	0	0	738	38	888	1	0	0
		-CB35	923	47	726	1	0	0	961	49	755	1	0	0	975	50	766	1	0	0	976	50	768	1	0	0	1164	60	915	1	0	0
		-B10	2022	104	6490	2	0	0	2106	108	6756	2	0	0	2135	109	6851	2	0	0	2139	110	6864	2	0	0	2549	131	8180	2	0	0
		-B20	1759	90	5680	2	0	0	1831	94	5913	2	0	0	1857	95	5996	2	0	0	1860	95	6007	2	0	0	2217	114	7159	2	0	0
		-B45	1776	91	2665	2	0	0	1849	95	2775	2	0	0	1874	96	2814	2	0	0	1878	96	2819	2	0	0	2238	115	3360	2	0	0
		-BII	1998	102	1029	1	0	0	2080	107	1071	1	0	0	2109	108	1086	1	0	0	2113	108	1088	1	0	0	2518	129	1297	1	0	0
		-BWW	1768	91	731	1	0	0	1840	94	761	1	0	0	1866	96	772	1	0	0	1870	96	774	1	0	0	2228	114	922	1	0	0
-BIV	1768	91	731	1	0	1	1840	94	761	1	0	1	1866	96	772	1	0	1	1870	96	774	1	0	1	2228	114	922	1	0	1		
-L26 (2600 lm)	29.3	Wide Flood	2730	93	1087	1	0	0	2842	97	1132	1	0	0	2882	98	1148	1	0	0	2887	99	1150	1	0	0	3441	117	1370	1	0	0
		-B02	857	29	913	1	0	0	893	30	951	1	0	0	905	31	964	1	0	0	907	31	966	1	0	0	1081	37	1151	1	0	0
		-CB20	767	26	964	1	0	0	798	27	1004	1	0	0	810	28	1018	1	0	0	811	28	1020	1	0	0	967	33	1216	1	0	0
		-CB35	1212	41	995	1	0	0	1261	43	1036	1	0	0	1279	44	1050	1	0	0	1281	44	1052	1	0	0	1527	52	1254	1	0	0
		-B10	2494	85	8346	2	0	0	2597	89	8689	2	0	0	2633	90	8810	2	0	0	2638	90	8827	2	0	0	3144	107	10519	2	0	0
		-B20	2306	79	7351	2	0	0	2401	82	7653	2	0	0	2434	83	7760	2	0	0	2439	83	7775	2	0	0	2907	99	9266	2	0	0
		-B45	2315	79	3578	2	0	0	2410	82	3725	2	0	0	2443	83	3777	2	0	0	2448	84	3784	2	0	0	2917	100	4510	2	0	0
		-BII	2567	88	1380	1	0	0	2672	91	1437	1	0	0	2710	92	1457	1	0	0	2715	93	1460	1	0	0	3235	110	1740	1	0	0
		-BWW	2256	77	975	1	0	0	2349	80	1015	1	0	0	2381	81	1029	1	0	0	2386	81	1031	1	0	0	2838	97	1226	1	0	0
-BIV	2256	77	975	1	0	1	2349	80	1015	1	0	1	2381	81	1029	1	0	1	2386	81	1031	1	0	1	2843	97	1229	1	0	1		