

LCMPD-BVL-RP : 5" & 7" ROUND BEVEL LUMENPAD PENDANT

1000LM - 1400LM (11W - 14W)

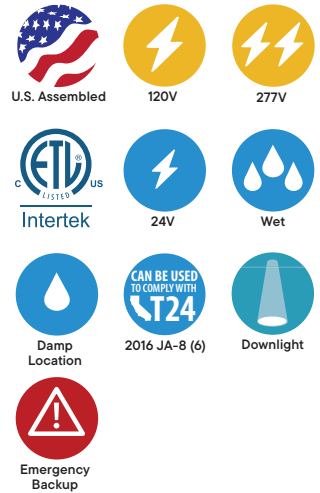
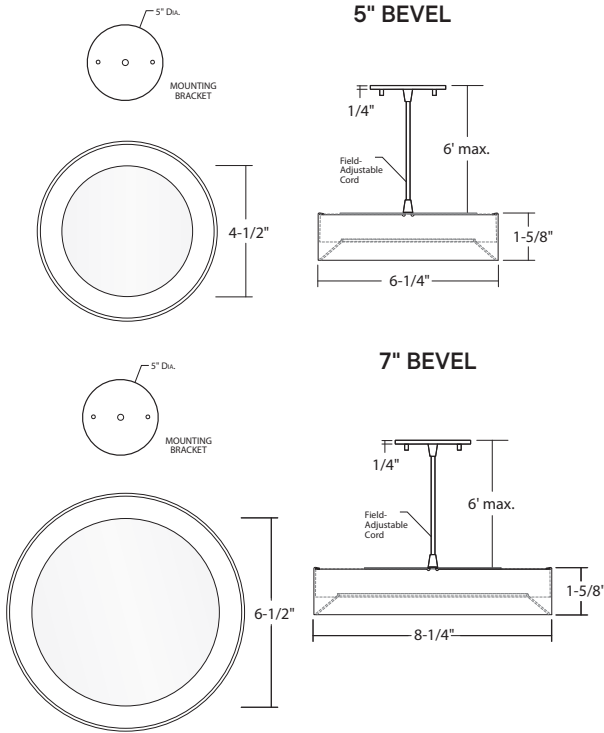

- New Bevel Trim Tapered Design
- Complements modern and architectural interiors
- Robust anodized color finishes
- WET LOCATION – For covered ceiling mount only
- Multiple Wireless Control Options
- Remote Emergency Available
- Various Color Temperatures and ColorSelect
- Low Glare

ORDERING : LCMPD-BVL-5RPW-TS27

Fixture	Finish	Control	Color Temperature	Emergency Options	Mounting
Fixture		Uplight	Color Temperature	Emergency Options	Emergency Options
5" Round Bevel LumenPad Pendant 1000lm (11W)	LCMPD-BVL-5RP	None 1000lm	Blank -LU10⁸	2700K (90 CRI) 3000K (90 CRI) 3500K (90 CRI) 4000K (90 CRI) 5000K (90 CRI)	-TS27 -TS30 -TS35 -TS40 -TS50
7" Round Bevel LumenPad Pendant 1400lm (14W)	LCMPD-BVL-7RP	Control TRIAC/ELV Dimming (120V) 0-10V Dimming (120V/277V) PWM Dimming (24VDC) Casambi Wireless Dimming (120V/277V) BubblyNet Wireless System (120V/277V) Athena Wireless Node (120V)	Blank² UE-D10⁶ -PWM -DCSM -DBNT -AWN	Color Select 2700K/3000K/3500K/4000K/5000K (90 CRI) RGB+W Color Changing Blue LED only Green LED only Red LED only	-TS2750 -RGBWV24⁵ -TBL⁵ -TGR⁵ -TRD⁵
Finish⁷					Mounting
White	W¹				Surface JBox Mount Blank
Black	B				1CCT/1INT Connector -1C1N
Silver	S¹				2CCT/2INT Connector -2C2N
Bronze	BZ				3CCT/1INT Connector -3C1N
Matte Gold	MG¹				

¹ Special Order Finish. Minimum order quantity (MOQ) applies. Orders less than MOQ are subject to a special paint set-up fee for the quantity ordered. Extended lead times may apply. Consult Factory.

² California Title 24/JA8 compliant with (Blank) TRIAC/ELV Dimming (120V) only.

³ Remote Location Emergency System only available for (UE-D10).

⁴ Check Wiring Diagram for Remote Emergency Backup.

⁵ (-RGBW24), (-TBL), (-GR), and (-TRD) must be ordered with (-PWM) controls and only available with LCMPD-BVL-7RP.

⁶ Requires 4" Octagon Electrical Box, 2-1/8" deep min. to install this luminaire.

⁷ Silver, Bronze, and Matt Gold finish comes standard with Black pendant mounting bracket and cord.

⁸ Uplight option -LU10 is (120V) input only.

SPECIFICATION

Application

The LumenPad Round LED Downlight Pendant Mount with Bevel Trim ring floats with elegance in contemporary architectural applications, a unique combination of innovative, elegantly minimalist design and high-quality LED performance. The luminaire is perfect for Retrofit, New Construction and Remodel Applications in low to medium height ceilings. Super thin profile is unobtrusive in design and has low glare. Lens is a Polycarbonate Frosted White Lens.

Housing

Bevel Ring is constructed from high strength 20Ga steel with durable anodized finish. Lens is a polycarbonate frosted white lens.

Mounting

Universal mounting hardware allows mounting to all standard octagonal electrical junction boxes. White pendant mounting bracket and white field adjustable cord for White finish. Black pendant mounting bracket and black field-adjustable cord for Black finish. Silver and Bronze finish come standard with Black pendant mounting bracket and black cord. Also available with the following Track Mounting: 1 & 2-Circuit/1-Neutral (-1C1N), 2-Circuit/2-Neutral (-2C2N), 3-Circuit/1-Neutral (-3C1N).

Finish

High quality anodized finish for maximum durability. Available in White, Black, Silver, Bronze and Matt Gold (custom).

Certifications and Listings

ETL/cETL listed. Assembled in USA.

Warranty

Covered by a 5-Year Warranty to be free of defects in materials and craftsmanship. Fixture should not be installed in applications with ambient temperature above 50°C/122°F. Doing so will result in reduced lamp life and voided warranty.

LED

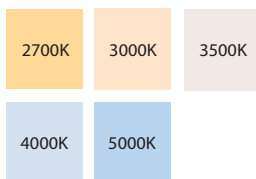

Available in 2700K, 3000K, 3500K, 4000K, 5000K, ColorSelect
2700K/3000K/3500K/4000K/5000K 90 CRI (Color Rendering Index).
LED's binned according to ANSI C78 377A for color temperature and chromaticity ranges.

SPECIFICATION (Continued)

FULL POWER EMERGENCY INVERTER (-EMAC or -EMAC347): 10W - 30W

- Must be installed in Dry Locations
- Wattage package will determine battery sent; corresponding wiring diagrams below
- 170 VDC output to AC DRIVER during EM mode

Not rated for outdoor mounting. Damp location rated.

-EMAC Lumen Data (Battery)

Fixture/Trim	LCMPD-BVL-5RP	Fixture/Trim	LCMPD-BVL-7RP	Fixture/Trim	LCMPD-BVL-7RPUE-D10
Fixture Wattage:	11W	Fixture Wattage:	14W	Fixture Wattage:	14W
Fixture Lumens:	1000	Fixture Lumens:	1100	Fixture Lumens:	1400
EM Lumens:	1000	EM Lumens:	1100	EM Lumens:	1400

<25W LOAD

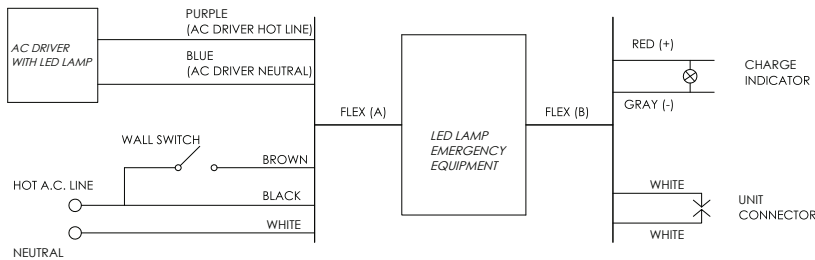

Input Voltage:	120-277VAC/60Hz
Output Voltage:	170VDC (120VAC Equivalent)
Wattage:	25W
Switching Time:	<1s
Charging Time:	24h
Operating Time:	90 minutes
Minimum Temperature:	0°C
Maximum Temperature:	50°C
Self-Diagnostic:	No

Control Options

ELV and TRIAC Driver 120V (-DIN):

Compatible with electronic low voltage, and 2-Wire incandescent dimmers. Also known as leading edge, Reverse Phase, Forward Phase dimming. Allows smooth dimming down to 5% depending upon the dimmer's limitations.

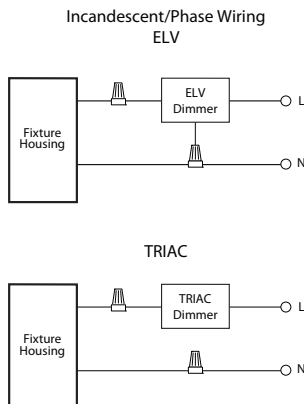

0-10V Driver 120V/277V (UE-D10):

Compatible with most existing 0-10V systems. Also known as fluorescent or 5-Wire dimming. Allows smooth dimming down to 5% depending upon the dimmer's limitations. Compatible with daylight harvesting controls.

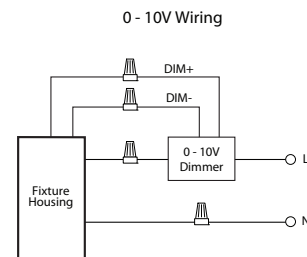

LCMPD-BVL-RP : 5" & 7" ROUND BEVEL LUMENPAD PENDANT 1000LM - 1400LM (11W - 14W)

PHOTOMETRY

LCMPD-BVL-5RPW-TS50 (1000lm, 11W, 5000K, CRI 90)

System Power:	11W	MULTIPLIERS	
Test Date:	04/2025	2700K	0.94
Beam Angle 50%:	117.2°	3000K	1.00
Field Angle 10%:	167.1°	3500K	0.99
Color Temperature:	5364K	4000K	0.99
CRI:	94.7	5000K	1.00
Lumens Delivered:	881		
CBCP:	287.9		
Power Factor:	0.92		

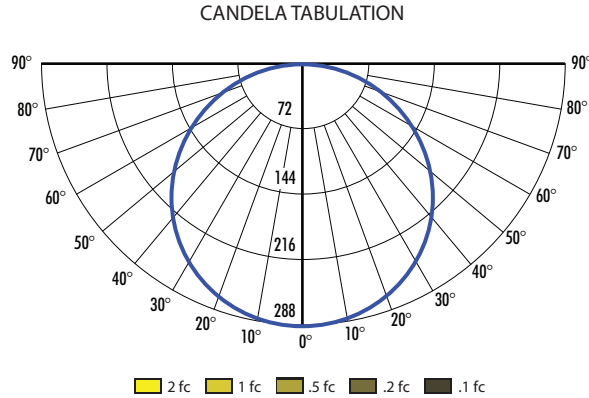

FOOTCANDLE DISTRIBUTION

Height	Beam Diameter	FC
8.0'	26.21'	4.50
9.0'	29.49'	3.55
10.0'	32.77'	2.88
11.0'	36.04'	2.38
12.0'	39.32'	2.00

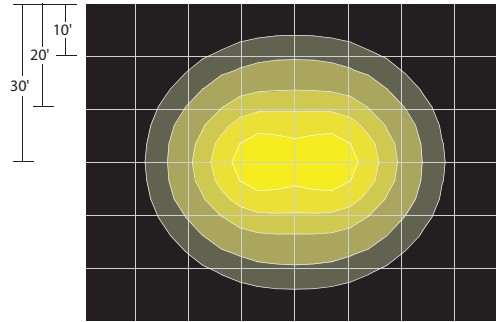

For 5", Achieve up to 14' Fixture Spacing at 10' Mounting Height while maintaining a min. of 2 fc at egress

LCMPD-BVL-5RPWUE-D10-TS40 (1000lm, 11W, 4000K, CRI 90)

System Power:	11W	MULTIPLIERS	
Test Date:	04/2025	3000K	0.96
Beam Angle 50%:	117.2°	3500K	1.03
Field Angle 10%:	167.2°	5000K	1.00
Color Temperature:	4254K		
CRI:	94.5		
Lumens Delivered:	919		
CBCP:	300		
Power Factor:	0.98		

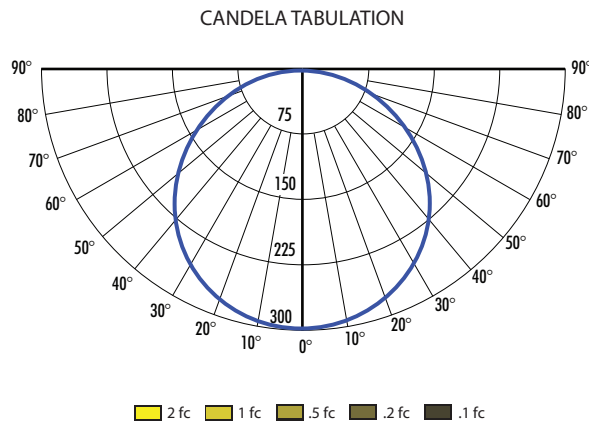

FOOTCANDLE DISTRIBUTION

Height	Beam Diameter	FC
8.0'	26.21'	4.69
9.0'	29.49'	3.70
10.0'	32.77'	3.00
11.0'	36.04'	2.48
12.0'	39.32'	2.08

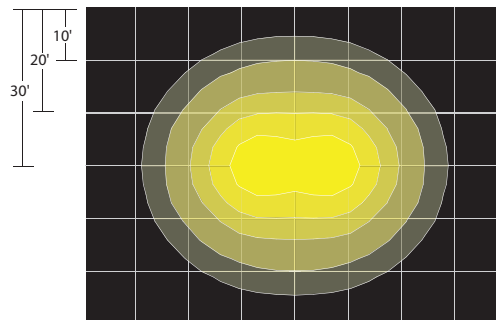

For 5", Achieve up to 14' Fixture Spacing at 10' Mounting Height while maintaining a min. of 2 fc at egress

2025.04.15

LCMPD-BVL-RP : 5" & 7" ROUND BEVEL LUMENPAD PENDANT 1000LM - 1400LM (11W - 14W)

PHOTOMETRY

LCMPD-BVL-7RPW-TS50 (1100lm, 14W, 4000K, CRI 90)

System Power:	15W	MULTIPLIERS	
Test Date:	04/2025	3000K	0.96
Beam Angle 50%:	120.5°	3500K	1.01
Field Angle 10%:	170.4°	4000K	1.00
Color Temperature:	3938K		
CRI:	95.0		
Lumens Delivered:	1132		
CBCP:	354.9		
Power Factor:	0.92		

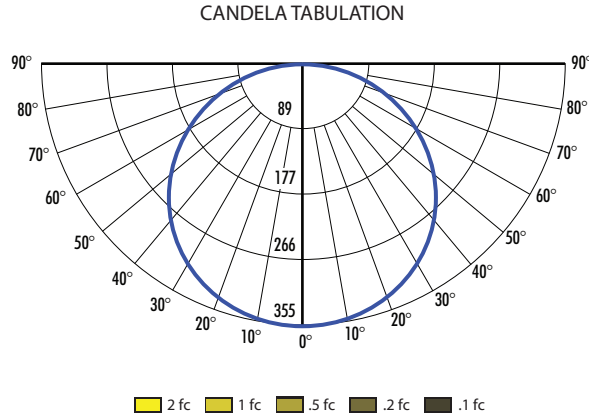

FOOTCANDLE DISTRIBUTION

Height	Beam Diameter	FC
6.0'	20.99'	9.86
8.0'	27.99'	5.54
10.0'	34.99'	3.55
12.0'	41.99'	2.46
14.0'	48.99'	1.81

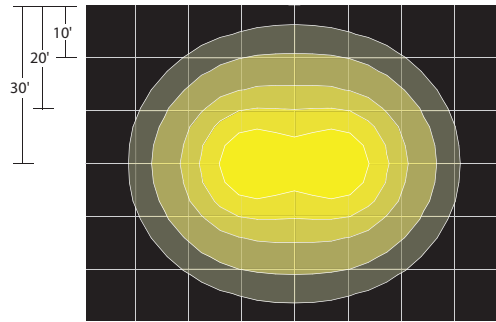

For 7", Achieve up to 18' Fixture Spacing at 10' Mounting Height while maintaining a min. of 2 fc at egress

LCMPD-BVL-7RPUE-D10-TS50 (1400lm, 14W, 5000K, CRI 90)

System Power:	14W	MULTIPLIERS	
Test Date:	04/2025	2700K	0.91
Beam Angle 50%:	116.7°	3000K	0.95
Field Angle 10%:	170.5°	3500K	1.00
Color Temperature:	5203K	4000K	1.02
CRI:	93.3	5000K	1.00
Lumens Delivered:	1461		
CBCP:	300		
Power Factor:	0.99		

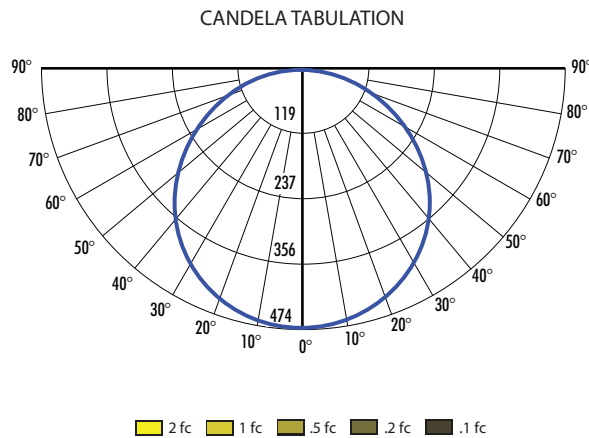

FOOTCANDLE DISTRIBUTION

Height	Beam Diameter	FC
6.0'	19.47'	13.18
8.0'	25.96'	7.41
10.0'	32.45'	4.74
12.0'	38.94'	3.29
14.0'	45.42'	2.42

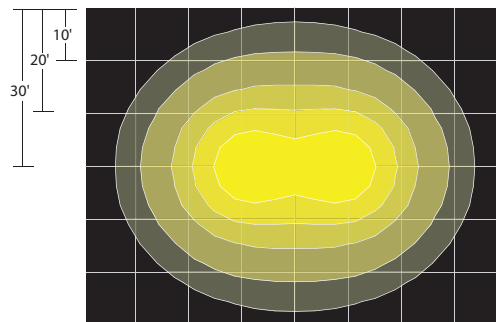

For 7", Achieve up to 18' Fixture Spacing at 10' Mounting Height while maintaining a min. of 2 fc at egress