

## LRLD15: 1.5" P-SERIES

MICRO RECESSED LED, ROUND APERTURE, 600LM/1000LM (8W/12W)

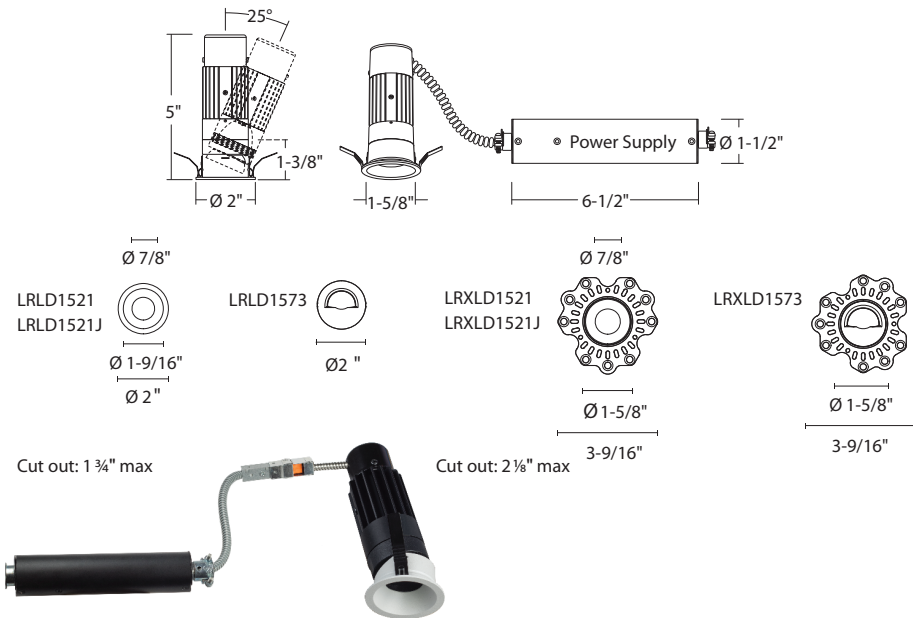

- 1.5" Micro-Aperture
- 1000lm (12W) option
- Dichroic Color Lens Options available
- Integral, Remote or Panel Box Power Supplies available
- Quick Ship Options available
- New Dim-to-Warm LED option available
- New Multiple Wireless Control Options available
- New Updated Pricing



Trim	Finish	Lumens	Beam	Color Temperature	Rating	Accessories	New Construction Frames
<b>Trim</b>	<b>Finish</b>	<b>Beam</b>	<b>Color Temperature</b>	<b>Accessories</b>			
<b>FLANGED</b>	Black	<b>B</b>	Wallwash only	<b>Blank</b>	2400K (90 CRI)	<b>-T24<sup>4</sup></b>	Clear Glass Lens <b>Blank</b>
Downlight <b>LRLD1521</b>	White	<b>W</b>	15° Beam	<b>-B15<sup>1</sup></b>	2700K (90 CRI)	<b>-T27</b>	Red Glass Lens <b>-RL-15</b>
Adjustable <b>LRLD1521J<sup>2</sup></b>	Matte Gold	<b>MG<sup>1</sup></b>	20° Beam	<b>-B20</b>	3000K (90 CRI)	<b>-T30</b>	Yellow Glass Lens <b>-YL-15<sup>1</sup></b>
Downlight	Custom Color	<b>CC<sup>1</sup></b>	40° Beam	<b>-B40</b>	3500K (90 CRI)	<b>-T35</b>	Blue Glass Lens <b>-BL-15</b>
Wallwash <b>LRLD1573<sup>5</sup></b>			50° Beam	<b>-B50</b>	4000K (90 CRI)	<b>-T40</b>	Green Glass Lens <b>-GL-15</b>
					3000K-1800K (90 CRI)	<b>-TWD<sup>1,4</sup></b>	Hex Cell Louver <b>-LVR</b>
							Soft Focus <b>-SFL<sup>1</sup></b>
							Micro Prismatic <b>-MPL<sup>1</sup></b>
<b>TRIMLESS</b>	<b>Lumens<sup>3</sup></b>				<b>Rating</b>		
Downlight <b>LRXLD1521</b>	600lm (8W)	<b>-L06</b>			None	<b>Blank</b>	
Adjustable <b>LRXLD1521J<sup>2</sup></b>	1000lm (12W)	<b>-L10</b>			Airtight Lensed	<b>-WL</b>	
Downlight					(Wet Location)		
Wallwash <b>LRXLD1573<sup>5</sup></b>							

Driver Setup	Lumens	Control	Emergency Options
<b>Driver Setup</b>		<b>Control</b>	<b>Control (Cont.)</b>
Integral Power Supply and Junction Box (1 Driver per Fixture)	<b>LD5INTJBX</b>	TRIAC/ELV (120V)	Blank
		0-10V (120V/277V)	<b>UE-D10</b>
		1%, 0-10V (120V/277V)	<b>UE-D10P1</b>
		UniDim™ 0-10V, TRIAC/ELV (120V/277V)	<b>UE-DUN</b>
<b>Lumens<sup>3</sup></b>		Unisen - Remotely Mounted Motion/Photosensor (120V)	<b>-SUN-RMT<sup>1,6</sup></b>
600lm (8W)	<b>-C020</b>		
1000lm (12W)	<b>-C030</b>		
			<b>-UNISENSE<sup>7</sup></b>
			<b>-DCSM<sup>7</sup></b>
			<b>-AWN<sup>1,6</sup></b>
			<b>-EMAC40<sup>8</sup></b>

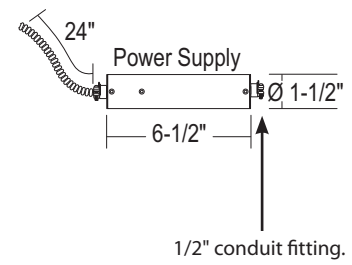

<sup>1</sup> Special order. Minimum order. Extended lead time may apply. Consult Factory.  
<sup>2</sup> Maximum ceiling thickness is 3/4" (to allow adjustability feature).  
<sup>3</sup> (-L06) must be ordered with Power Supply Lumen Option (-C020) and (-L10) must be ordered with Power Supply Lumen Option (-C030: 1000lm (12W)).  
<sup>4</sup> (-TWD) and (-T24) not available with (-B15) and only available with the Power Supply Lumen option of (-C030: 1000lm (12W)).  
<sup>5</sup> Beam Spread Options not available with Wallwash trims LRLD1573/LRXLD1573.  
<sup>6</sup> (-SUN-RMT) & (-AWN) sensors sent with mounting clips for existing ceiling applications. Consult Factory for Layout Assistance.  
<sup>7</sup> For power supply, LD5INTJBX, (-DCSM) only available for (-C030) option.  
<sup>8</sup> (-EMAC40) can be wired for loads (>40W) with 0-10V dimmable driver; see page 9.  
<sup>9</sup> Consult Factory for custom pre-wired connector lengths.  
<sup>10</sup> For LD5RMTJBX power supply: (-4QC, -5QC) only compatible with Blank: TRIAC/ELV Dimming.

2026.02.10

## DRIVER SETUP

### POWER SUPPLY: LD5RMTJBX

Driver Setup	Lumens	Control	Pre-Wired	Lengths	Emergency Options
<b>Driver Setup</b>		<b>Lumens<sup>3</sup></b>	<b>Control</b>		<b>Pre-Wired (Quick Connects)</b>
Remote Power Supply (1 Driver for Multiple Fixtures)	<b>LD5RMTJBX</b>	600lm (8W) <b>-C020</b> 1000lm (12W) <b>-C030</b>	TRIAC/ELV (120V) 0-10V (120V/277V) Unisense - Remotely Mounted Motion/Photosensor (120V) Unisense - Remotely Mounted Motion/Photosensor (120V/277V) Casambi Wireless Dimming (120V/277V) Bubblynet Wireless Dimming (120V/277V) Athena Wireless Node (120V)	<b>Blank<sup>10</sup></b> <b>UE-D10</b> <b>-SUN-RMT<sup>1,6</sup></b>  <b>-SUN-RMT-1227<sup>1,6</sup></b>  <b>-DCSM<sup>1</sup></b>  <b>-DBNT<sup>1</sup></b>  <b>-AWN<sup>1,6</sup></b>	2 pre-wired connectors <b>-2QC</b> 3 pre-wired connectors <b>-3QC</b> 4 pre-wired connectors <b>-4QC<sup>10</sup></b> 5 pre-wired connectors <b>-5QC<sup>10</sup></b>
					<b>Lengths (each QC)<sup>9</sup></b>
					None <b>Blank</b> 4' Total length <b>-L04</b> 6' Total length <b>-L06</b> 12' Total length <b>-L12</b>
					<b>Emergency Options</b>
					Remote Emergency Backup (40W) <b>-EMAC40<sup>8</sup></b>

### Remote Power Supply LD5RMTJBX:

- 1 Remote supply for 2-6 fixtures.
- 16 Ga aluminum junction box with 1/2" conduit knockouts.
- Pre-wired whips offered in standard 4ft, 6ft, and 12ft length.
- Consult factory for custom or extended whip lengths.
- Overall Dimensions (L x W x H): 11" x 2-7/8" x 1-3/4".

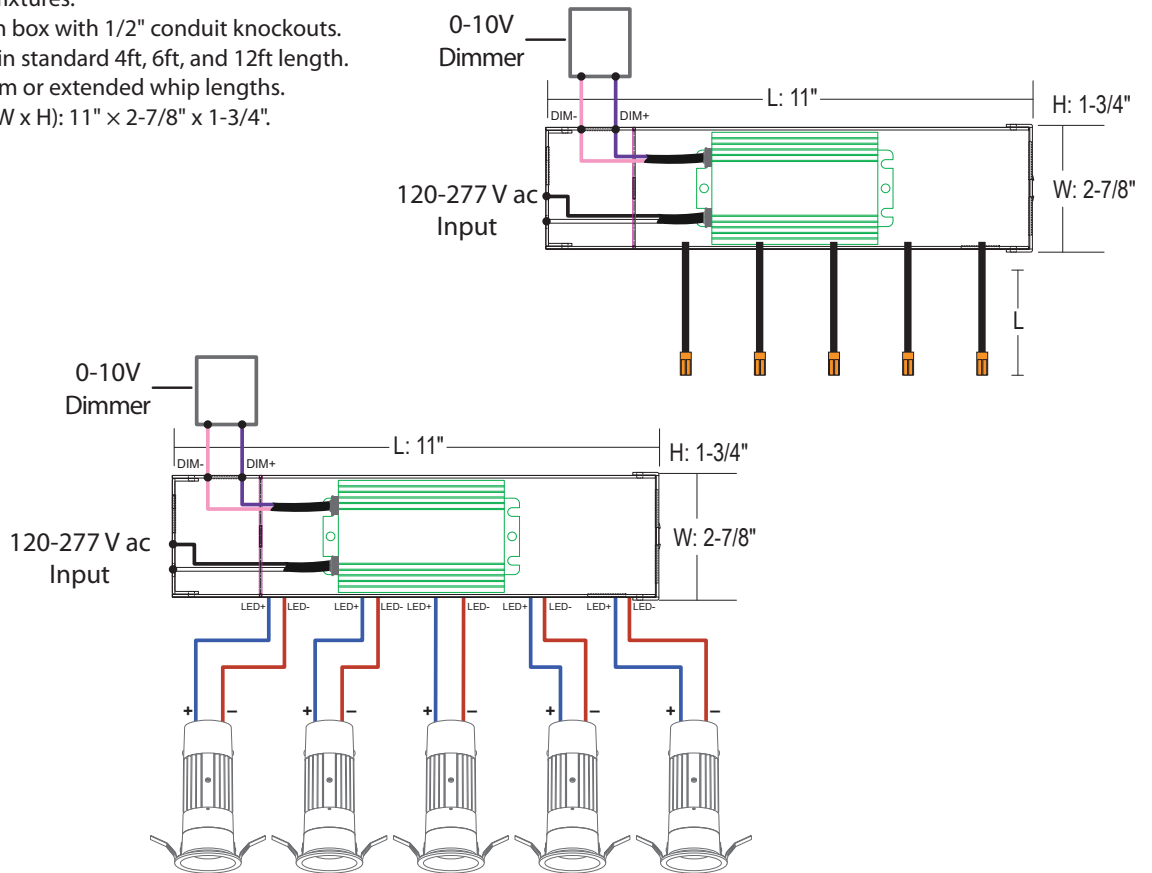

<sup>1</sup> Special order. Minimum order. Extended lead time may apply. Consult Factory.

<sup>2</sup> Maximum ceiling thickness is 3/4" (to allow adjustability feature).

<sup>3</sup> (-L06) must be ordered with Power Supply Lumen Option (-C020) and (-L10) must be ordered with Power Supply Lumen Option (-C030).

<sup>4</sup> (-TWD) and (-T24) not available with (-B15) and only available with the Power Supply Lumen option of (-C030: 1000lm (12W)).

<sup>5</sup> Beam Spread Options not available with Wallwash trims LRLD1573/LRXLD1573.

<sup>6</sup> (-SUN-RMT) & (-AWN) sensors sent with mounting clips for existing ceiling applications. Consult Factory for Layout Assistance.

<sup>7</sup> For power supply, LD5INTJBX, (-DCSM) only available for (-C030) option.

<sup>8</sup> (-EMAC40) can be wired for loads (>40W) with 0-10V dimmable driver; see page 9.

<sup>9</sup> Consult Factory for custom pre-wired connector lengths.

<sup>10</sup> For LD5RMTJBX power supply: (-4QC, -5QC) only compatible with Blank: TRIAC/ELV Dimming.

## DRIVER SETUP (Continued)

### POWER SUPPLY: LD5PNLJBX

Driver Setup	# of Drivers	Lumens	Control	Emergency Options		
<b>Driver Setup</b>	<b># of Drivers</b>	<b>Lumens<sup>3</sup></b>	<b>Control</b>	<b>Emergency Options</b>		
Remote Panel Box Up to 8 Drivers (1 Driver per Fixture)	<b>LD5PNLJBX</b>	1 Driver - <b>D01</b> 2 Drivers - <b>D02</b> 3 Drivers - <b>D03</b> 4 Drivers - <b>D04</b> 5 Drivers - <b>D05</b> 6 Drivers - <b>D06</b> 7 Drivers - <b>D07</b> 8 Drivers - <b>D08</b>	600lm (8W) - <b>C020</b> 1000lm (12W) - <b>C030</b>	TRIAC/ELV (120V) 0-10V (120V/277V) 1%, 0-10V (120V/277V) UniDim™ 0-10V, TRIAC/ELV (120V/277V) Casambi Wireless Dimming (120V/277V) BubblyNet Wireless System (120V/277V)	<b>Blank</b> <b>UE-D10</b> <b>UE-D10P1</b> <b>UE-DUN</b> <b>-DCSM<sup>1</sup></b> <b>-DBNT<sup>1</sup></b>	Remote Emergency Backup (40W) (Up to 4 fixtures) <b>-EMAC40<sup>8</sup></b>

### Remote Panel Box LD5PNLJBX:

- 1 remote panel box power supply for 1-8 fixtures.
- 16Ga Steel NEMA 1 enclosure with ANSI 61 gray powder coat finish.
- NEMA 1 enclosure can house up to (8) LED drivers.
- Box equipped with screw door and knockouts on all 4 sides for 1/2", 3/4" and 1" conduit feeds.
- Box is cULus listed with UNSPSC39121301.
- Drivers pre-wired with low-voltage LED output to DIN terminals for easy poke-in connections (12–28 AWG) and standard 0–10 V dimming.
- Multiple Boxes can be ordered for larger setups.
- Overall Dimensions (L x W x H): 15-1/8" x 12-1/8" x 4".

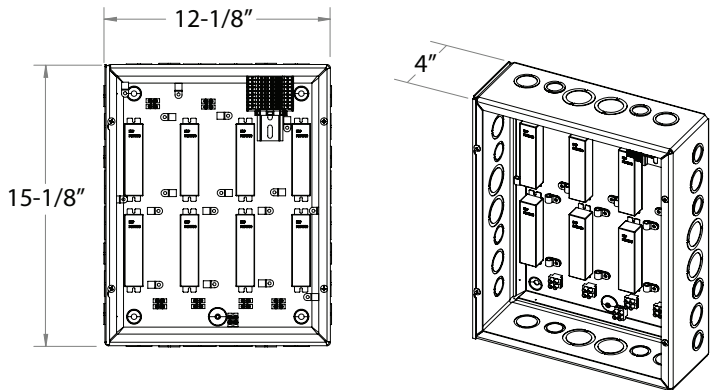

<sup>1</sup> Special order. Minimum order. Extended lead time may apply. Consult Factory.

<sup>2</sup> Maximum ceiling thickness is 3/4" (to allow adjustability feature).

<sup>3</sup> (-L06) must be ordered with Power Supply Lumen Option (-C020) and (-L10) must be ordered with Power Supply Lumen Option (-C030).

<sup>4</sup> (-TWD) and (-T24) not available with (-B15) and only available with the Power Supply Lumen option of (-C030: 1000lm (12W)).

<sup>5</sup> Beam Spread Options not available with Wallwash trims LRLD1573/LRXLD1573.

<sup>6</sup> (-SUN-RMT) & (-AWN) sensors sent with mounting clips for existing ceiling applications. Consult Factory for Layout Assistance.

<sup>7</sup> For power supply, LD5INTJBX, (-DCSM) only available for (-C030) option.

<sup>8</sup> (-EMAC40) can be wired for loads (>40W) with 0-10V dimmable driver; see page 9.

<sup>9</sup> Consult Factory for custom pre-wired connector lengths.

<sup>10</sup> For LD5RMTJBX power supply: (-5QC, -4QC) only compatible with Blank: TRIAC /ELV Dimming.

## NEW CONSTRUCTION FRAMES

### /LHLD15-FRM: Non-IC (Flanged)

<i>Fits the following</i>	
LRLD1521	LRLDQ1521
LRLD1521J	LRLDQ1521J
LRLD1573	LRLDQ1573

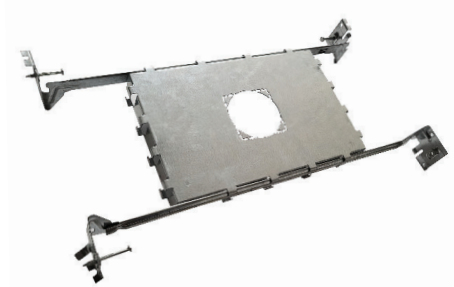
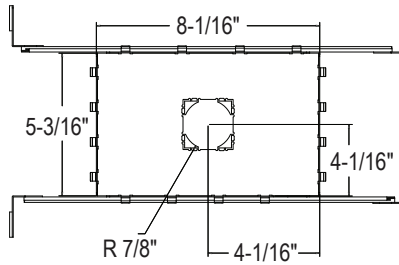

### /LHXL15-FRM: Non-IC (Trimless)

<i>Fits the following</i>	
LRXLD1521	LRXLDQ1521
LRXLD1521J	LRXLDQ1521J
LRXLD1573	LRXLDQ1573

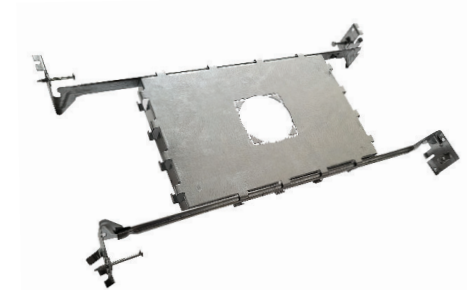
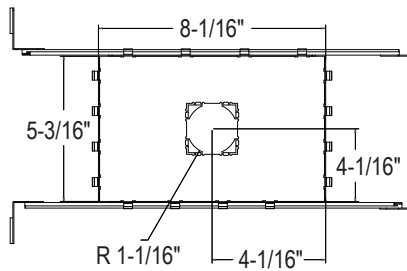
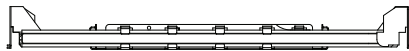

### /LHLD15IC-FRM & /LHXL15IC-FRM: Type IC (Flanged/Trimless)

<i>Fits the following</i>	
LRLD1521	LRXLD1521
LRLD1521J	LRXLD1521J
LRLD1573	LRXLD1573

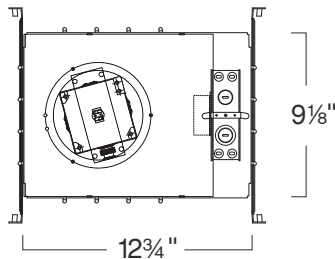
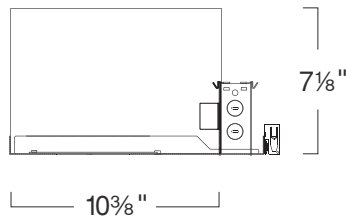

### /LHFR15: Fire-Rated Frame Type IC/1-Hour

<i>Fits the following</i>	
LRLD1521	LRXLD1521
LRLD1521J	LRXLD1521J
LRLD1573	LRXLD1573

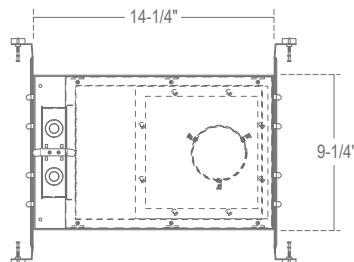
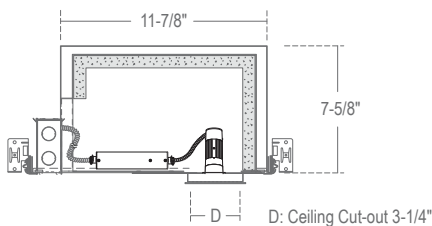

## SPECIFICATION

### Application

The 1.5" Micro Recessed LED Downlight's compact profile makes it perfect for low-ceiling and shallow-plenum environments in residential, hospitality, retail, and commercial spaces. Designed for precision lighting, it offers excellent beam control and low glare, making it well-suited for accent, task, or general lighting where visual comfort and architectural integration are paramount. Available in fixed, wallwash, and adjustable versions with up to 25° tilt for precise illumination and design flexibility.

### Housing

Housing supports multiple installation methods. Designed for remodel applications with sheetrock or panel ceiling systems. Optional new construction frame-in kits available. See options (LHLD15-FRM), (LHXL15-FRM), (LHLD15IC-FRM), (LHFRLD15).

### Mounting

FLANGED TRIM OPTIONS		TRIMLESS OPTIONS	
LRLD1521	Specified for integration with sheetrock, acoustic tile, and other panelized ceiling systems, providing a secure and flush-mounted interface via lateral spring clips.	LRXLD1521	Specified for integration with sheetrock ceilings with a mud-in finish.
LRLD1521J		LRXLD1521J	
LRLD1573		LRXLD1573	
Min Ceiling Thickness = 1/2".		Max Ceiling Thickness = 3".	
Max Ceiling Thickness = 3".			

### Thermal Management:

Integrated cast-aluminum heat sink ensures efficient thermal dissipation, maximizing heat rejection to enhance LED performance and extend lifespan.

### Junction Box

LD5INTJBX: Cylindrical Aluminum Junction Box with 1/2" conduit fitting.  
 LD5RMTJBX: 16Ga Aluminum Junction Box with x4 1/2" conduit knockouts.  
 LD5PNLJBX: 16Ga Steel NEMA enclosure; 4 sides with 1/2", 3/4" and 1" conduit knockouts and a screw door.

### Trim Ring

#### Flanged:

Spring clips securely fasten the round trim and LED light engine to the sheetrock ceiling or housing frame.

#### Flangeless:

Drywall screws fasten the reflector and die-cast aluminum trim to the sheetrock ceiling or housing frame by securing them to the trim ring.

### Finishes:

Standard options are White (W) and Black (B). Matte Gold (MG) available as special order. Consult Factory for Custom Color RAL finishes. (Charges may Apply).

**SPECIFICATION (Continued)**

**Minimum Mounting Centers**

Mud in mounting flanges interlock with each other for perfect alignment when tight spacing is required.

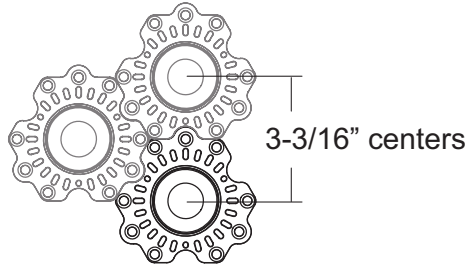

**Reflector Optics**

Field-changeable multifaceted TIR reflector securely locks onto the LED light engine for precise optical alignment.

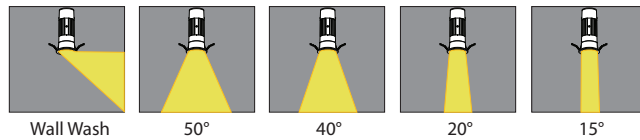

**Lens:**

1. Includes clear lens as standard.
2. Black Hexcell Louver option available for glare control.
3. Soft Focus Lens option available for beam smoothing.
4. Microprismatic Lens options available for uniforming light distribution.

**Filter Lenses:**

Dichroic Glass, Red Lens (-RL-15), Green Lens (-GL-15), and Blue Lens (-BL-15) shown below in 2700K, 3500K and 4000K color temperatures.

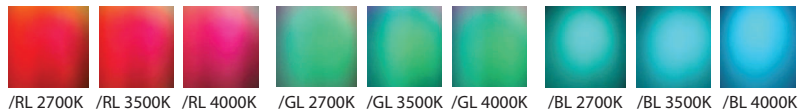

**LED**

**Light Engine:**

COB (Chip on Board) LED is field replaceable via quick disconnect terminals. Meets CA Title 24 Requirements and other standards restricting the use of Medium Base and Bi-Pin sockets.

**Lumen Maintenance:**

Minimum 50,000 hours L70 life based on ANSI TM-21 calculation from LM80 standardized test results.

## SPECIFICATION (Continued)

### Color Temperature:

COLOR TEMP:	2400K	2700K	3000K	3500K	4000K	1800K-3000K
CRI:	90	90	90	90	90	90

Consult factory for availability of other color temperatures.

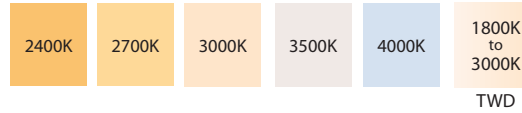

### Binning:

3 SDCM binning is standard, with 2 SDCM available upon request. Consult Factory.

## Control Options

Triac dimming to 5%, 120V Only

0-10V to 5%, 120V/277V (UE-D10)

0-10V to 1%, 120V/277V (UE-D10P1)

0-10V to 5%, 120V/277V, ELV, and Triac (UE-DUN)

### ELV and TRIAC Driver 120V (-DIN):

Compatible with electronic low voltage, and 2-Wire incandescent dimmers. Also known as leading edge, Reverse Phase, Forward Phase dimming. Allows smooth dimming down to 5% depending upon the dimmer's limitations.

### 0-10V Driver 120V/277V (UE-D10):

Compatible with most existing 0-10V systems. Also known as fluorescent or 5-Wire dimming. Allows smooth dimming down to 5% depending upon the dimmer's limitations. Compatible with daylight harvesting controls.

### UniDim™ Driver 120V/277V (UE-DUN):

All in one ELV and TRIAC phase dimming (120V only), and 0-10V dimming (120V/277V). Works with most 3-Wire ELV, 2-Wire incandescent and 120V/277V 5-Wire 0-10V fluorescent dimmers.

Incandescent/Phase Wiring  
ELV

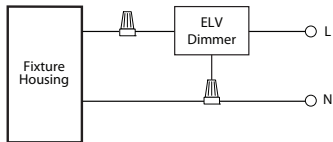

TRIAC

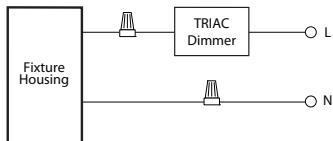

0 - 10V Wiring

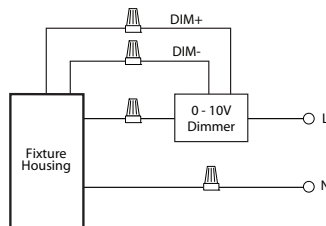

Incandescent/Phase Wiring  
ELV

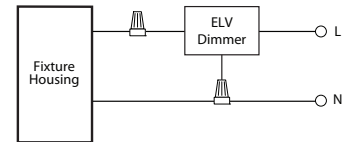

TRIAC

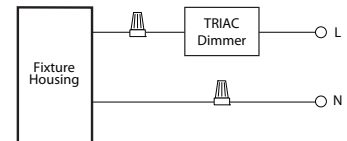

0 - 10V Wiring

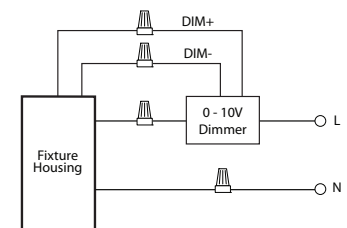

## SPECIFICATION (Continued)

### FULL POWER EMERGENCY INVERTER (-EMAC40)

- Must be installed in Dry Locations
- Wattage package will determine battery sent; corresponding wiring diagrams below
- 170 VDC output to AC DRIVER during EM mode

**Not rated for outdoor mounting. Damp location rated.**

#### -EMAC Lumen Data (Battery)

Fixture/Trim	LRLD1521 with C020	Fixture/Trim	LRLD1521 with C030
Fixture Wattage:	8W	Fixture Wattage:	12W
Fixture Lumens:	600	Fixture Lumens:	1000
EM Lumens:	600	EM Lumens:	1000

#### <40W LOAD

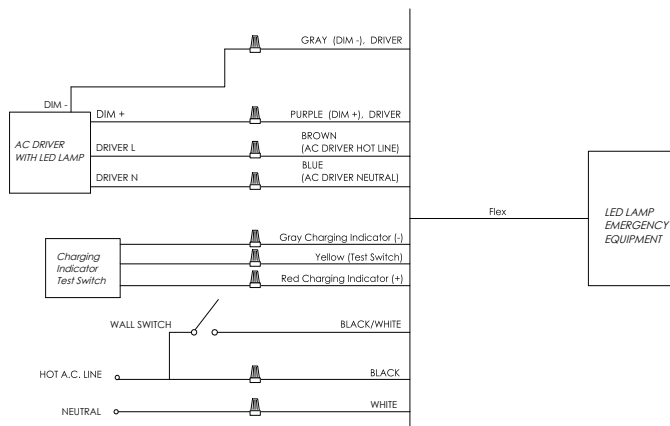

Input Voltage:	120-277VAC or 347VAC/60Hz
Output Voltage:	170VDC (120VAC Equivalent)
Wattage:	30W
Switching Time:	<1s
Charging Time:	24h
Operating Time:	90 minutes
Minimum Temperature:	0°C
Maximum Temperature:	50°C
Self-Diagnostic:	Yes

#### >40W LOAD

- 0-10V dimmable driver required

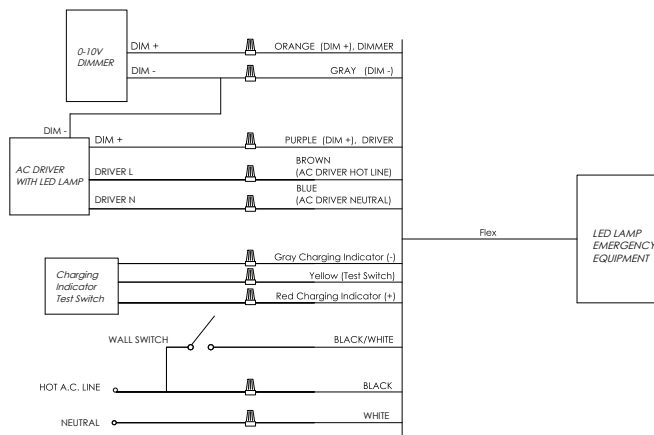

Input Voltage:	120-277VAC or 347VAC/60Hz
Output Voltage:	170VDC (120VAC Equivalent)
Wattage:	44W
Switching Time:	<1s
Charging Time:	24h
Operating Time:	90 minutes
Minimum Temperature:	0°C
Maximum Temperature:	50°C
Self-Diagnostic:	Yes

## SPECIFICATION (Continued)

### Electrical Data

UL Class P rated, Programmable Constant Current Drivers  
 Input Voltage – 120V & 277V, 50-60 HZ  
 Input Current – 0.5A @ 120V, 0.23A @ 277V  
 Power Factor – > 0.9  
 Inrush Current – Meets NEMA-410 Requirements  
 Efficiency – 90%

### Certifications and Listings

PETL/cETL listing to UL1598 and UL8750 standards  
 Title 24/JA8 Compliant.

### Title 24/JA8 Compliant

LRLD1521_-B_-T27	LRLD1521J_-B_-T27	LRLD1573_-B_-T27
LRLD1521_-B_-T30	LRLD1521J_-B_-T30	LRLD1573_-B_-T30
LRLD1521_-B_-T35	LRLD1521J_-B_-T35	LRLD1573_-B_-T35
LRLD1521_-B_-T40	LRLD1521J_-B_-T40	LRLD1573_-B_-T40
LRXLD1521_-B_-T27	LRXLD1521J_-B_-T27	LRXLD1573_-B_-T27
LRXLD1521_-B_-T30	LRXLD1521J_-B_-T30	LRXLD1573_-B_-T30
LRXLD1521_-B_-T35	LRXLD1521J_-B_-T35	LRXLD1573_-B_-T35
LRXLD1521_-B_-T40	LRXLD1521J_-B_-T40	LRXLD1573_-B_-T40

### Quick Ship Items

LRLD1521W-L06-B20-Txx	LRLD1521JW-L06-B20-Txx	LRXLD1521W-L06-B20-Txx	LRXLD1521JW-L06-B20-Txx
LRLD1521W-L06-B40-Txx	LRLD1521JW-L06-B40-Txx	LRXLD1521W-L06-B40-Txx	LRXLD1521JW-L06-B40-Txx
LRLD1521W-L06-B50-Txx	LRLD1521JW-L06-B50-Txx	LRXLD1521W-L06-B50-Txx	LRXLD1521JW-L06-B50-Txx

### Caution

LITON recommends use of surge protectors on the power entering LED Housings. Surge damage is not covered by warranty. (+1KV). Fixtures must be grounded in accordance with national, state and/or local electrical codes. Failure to do so may result in serious personal injury.

### Warranty

Covered by a 5-Year Warranty to be free of defects in materials and craftsmanship. Recommended for applications where ambient temperatures do not exceed 35°C. Installations exceeding this temperature will result in reduced LED lamp life and a voided warranty.

## PHOTOMETRY - DOWNLIGHT & ADJUSTABLE (Data also applies for LRLD1521J, LRXLD1521, LRXLD1521J)

### LRLD1521W-B15-T40 (15°, 4000K)

System Power:	12.4W
Test Date:	07/2025
Beam Angle 50%:	14.7°
Field Angle 10%:	26.1°
Color Temperature:	3941K
CRI:	93.8
Lumens Delivered:	457
CBCP:	5780
Power Factor:	0.99

MULTIPLIERS	
TRIM FINISH	
Matte Gold :	0.99
Black :	0.99
<b>White :</b>	<b>1.00</b>
LUMENS	
-C020 :	0.74
<b>-C030 :</b>	<b>1.00</b>
CCT	
1800K-3000K :	0.62
2700K :	0.91
3000K :	0.94
3500K :	0.97
<b>4000K :</b>	<b>1.00</b>
LENSES	
-LVR :	0.71
-SFL :	0.88
-MPL :	0.80
-RL-15 :	0.13
-GL-15 :	0.20
-BL-15 :	0.36

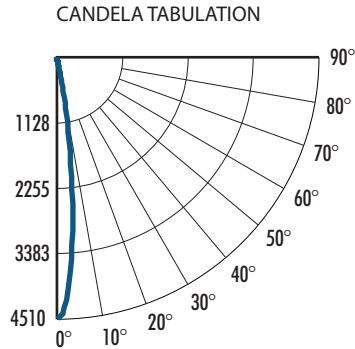

FOOTCANDLE DISTRIBUTION

Height	Beam Diameter	FC
10.0'	2.49'	44.99
15.0'	3.74'	20.00
20.0'	4.98'	11.25
25.0'	6.23'	7.20
30.0'	7.47'	5.00
35.0'	8.72'	3.67

### LRLD1521W-B20-T40 (20°, 4000K)

System Power:	12.4W
Test Date:	07/2025
Beam Angle 50%:	21.6°
Field Angle 10%:	40.3°
Color Temperature:	3941K
CRI:	93.8
Lumens Delivered:	867
CBCP:	5130
Power Factor:	0.99

MULTIPLIERS	
TRIM FINISH	
Matte Gold :	0.99
Black :	0.99
<b>White :</b>	<b>1.00</b>
LUMENS	
-C020 :	0.74
<b>-C030 :</b>	<b>1.00</b>
CCT	
1800K-3000K :	0.62
2700K :	0.91
3000K :	0.94
3500K :	0.97
<b>4000K :</b>	<b>1.00</b>
LENSES	
-LVR :	0.71
-SFL :	0.88
-MPL :	0.80
-RL-15 :	0.13
-GL-15 :	0.20
-BL-15 :	0.36

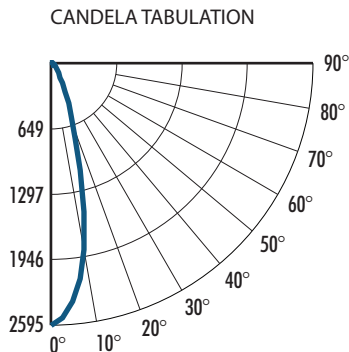

FOOTCANDLE DISTRIBUTION

Height	Beam Diameter	FC
10.0'	10.46'	25.95
15.0'	7.37'	11.53
20.0'	9.82'	6.49
25.0'	12.28'	4.15
30.0'	14.74'	2.88
35.0'	17.19'	2.12

2025.07.07

## PHOTOMETRY - DOWNLIGHT & ADJUSTABLE (Data also applies for LRLD1521J, LRXLD1521, LRXLD1521J)

### LRLD1521W-B40-T40 (40°, 4000K)

System Power:	12.4W
Test Date:	07/2025
Beam Angle 50%:	41.3°
Field Angle 10%:	64.2°
Color Temperature:	3941K
CRI:	93.8
Lumens Delivered:	1021
CBCP:	2100
Power Factor:	0.99

MULTIPLIERS	
TRIM FINISH	
Matte Gold :	0.99
Black :	0.99
<b>White :</b>	<b>1.00</b>
LUMENS	
-C020 :	0.74
<b>-C030 :</b>	<b>1.00</b>
CCT	
1800K-3000K :	0.62
2700K :	0.91
3000K :	0.94
3500K :	0.97
<b>4000K :</b>	<b>1.00</b>
LENSES	
-LVR :	0.71
-SFL :	0.88
-MPL :	0.80
-RL-15 :	0.13
-GL-15 :	0.20
-BL-15 :	0.36

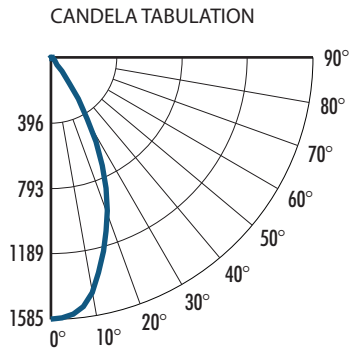

FOOTCANDLE DISTRIBUTION		
Height	Beam Diameter	FC
10.0'	8.80'	15.85
12.0'	10.56'	11.01
15.0'	13.20'	7.05
20.0'	17.60'	3.96
25.0'	22.00'	2.54

### LRLD1521W-B50-T40 (50°, 4000K)

System Power:	12.4W
Test Date:	07/2025
Beam Angle 50%:	50.5°
Field Angle 10%:	73.0°
Color Temperature:	3941K
CRI:	93.8
Lumens Delivered:	1048
CBCP:	1430
Power Factor:	0.99

MULTIPLIERS	
TRIM FINISH	
Matte Gold :	0.99
Black :	0.99
<b>White :</b>	<b>1.00</b>
LUMENS	
-C020 :	0.74
<b>-C030 :</b>	<b>1.00</b>
CCT	
1800K-3000K :	0.62
2700K :	0.91
3000K :	0.94
3500K :	0.97
<b>4000K :</b>	<b>1.00</b>
LENSES	
-LVR :	0.71
-SFL :	0.88
-MPL :	0.80
-RL-15 :	0.13
-GL-15 :	0.20
-BL-15 :	0.36

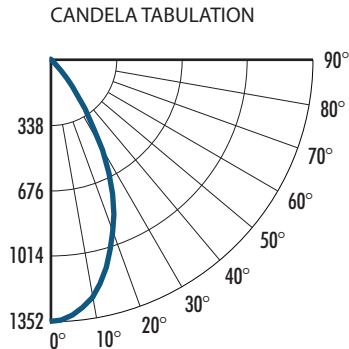

FOOTCANDLE DISTRIBUTION		
Height	Beam Diameter	FC
10.0'	10.23'	13.52
12.0'	12.28'	9.39
15.0'	15.35'	6.01
20.0'	20.47'	3.38
25.0'	25.59'	2.16

## PHOTOMETRY - WALL WASH (Data also applies for LRXLD1573B)

### LRLD1573B-T40 (Wall Wash, 4000K)

System Power: 12.4W  
 Test Date: 07/2025  
 Color Temperature: 3941K  
 CRI: 93.8  
 Lumens Delivered: 560  
 CBCP: 846  
 Power Factor: 0.99

MULTIPLIERS	
TRIM FINISH	
Matte Gold :	0.99
Black :	0.99
<b>White :</b>	<b>1.00</b>
LUMENS	
-C020 :	0.74
<b>-C030 :</b>	<b>1.00</b>
CCT	
1800K-3000K :	0.62
2700K :	0.91
3000K :	0.94
3500K :	0.97
<b>4000K :</b>	<b>1.00</b>

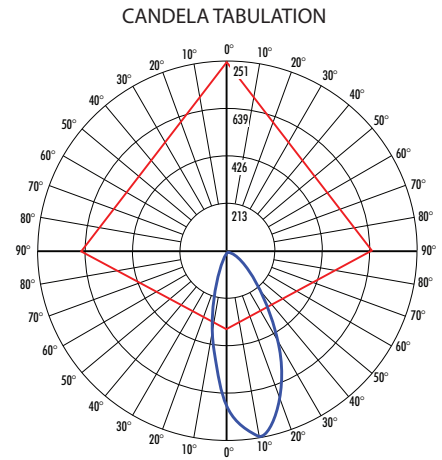

## PERFORMANCE DATA

### LUMINAIRE SPACED 2.5' FROM WALL

#### Footcandles On Wall

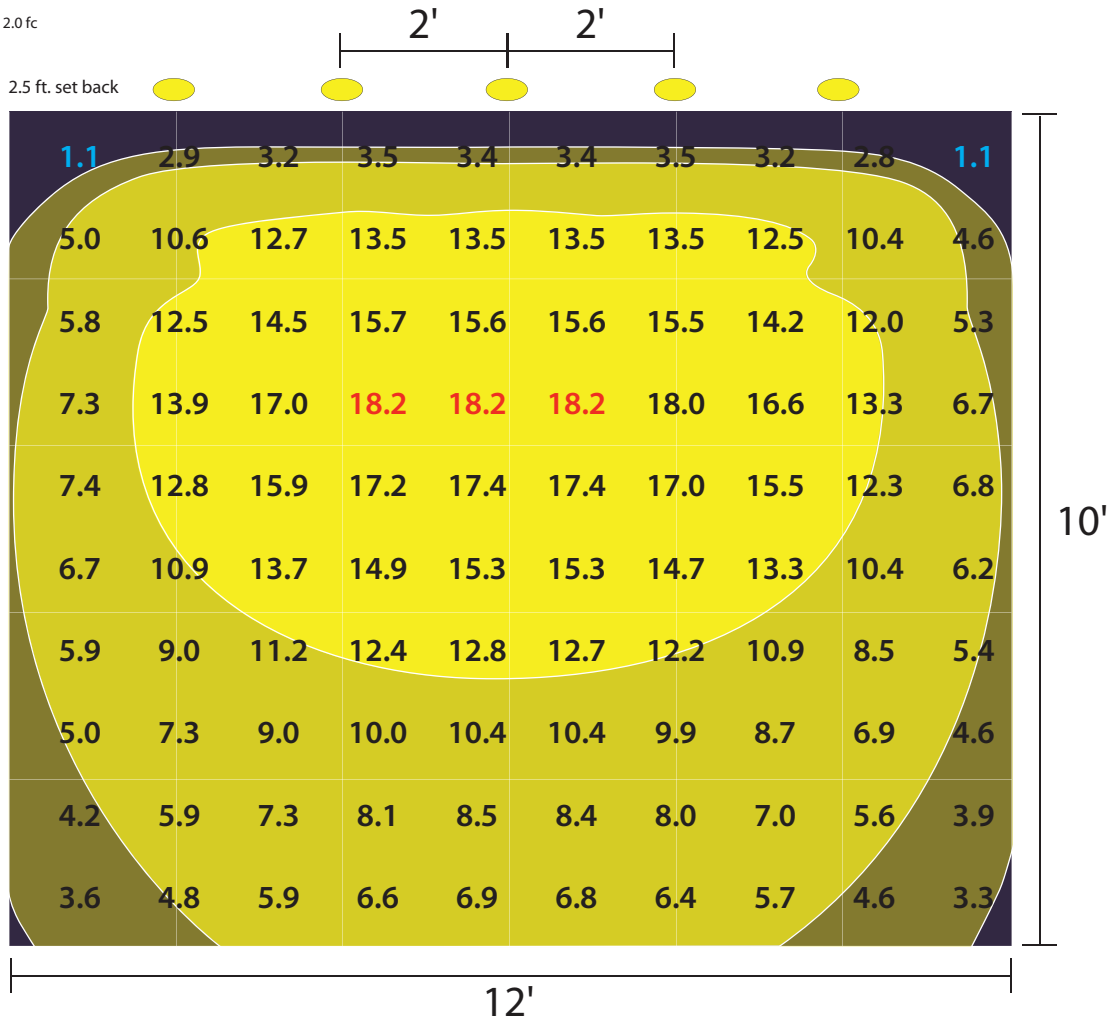

2023.10.15