

## LRLDQ26: 2.5" GEN2 P·SERIES

SQUARE APERTURE FLANGED 1000LM-2400LM (15W/22W/30W)

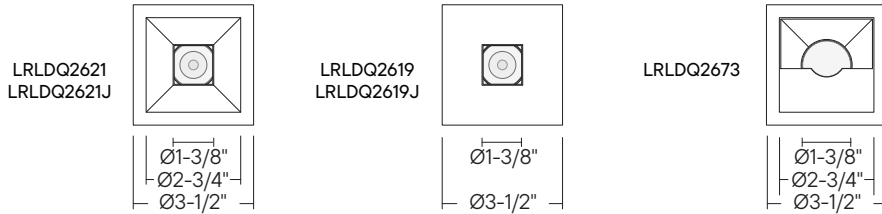

- Up to 30W, 2400lm
- Multiple Beam Spreads and Color Temperatures including Dim to Warm
- One Piece Die-Cast Construction
- Larger Aperture for Easy Installation
- Airtight Lens Wet Location Option
- Type IC Option Available
- Multiple Wireless Control Options

Trim	Trim Finish	Lumens	Beam Spread	Color Temperature	Control	Rating	Accessories
<b>Trim Style</b>	<b>FLANGED</b>	<b>Beam Spread</b>	<b>Blank<sup>4</sup></b>	<b>Control</b>	<b>Rating</b>		
Downlight Bevel	<b>LRLDQ2621</b>	25° Beam	<b>-B25</b>	Non-Dimming (120V)	<b>Blank</b>	None	<b>Blank</b>
Adjustable Bevel	<b>LRLDQ2621J</b>	35° Beam	<b>-B35</b>	PWM Dimming (24VDC)	<b>-PWM</b>	Airtight Lensed (Wet Location)	<b>-WL</b>
Downlight Pinhole	<b>LRLDQ2619</b>	45° Beam	<b>-B54</b>	TRIAC/ELV Dimming (120V)	<b>-DIN</b>	4" J-Box (Chicago Plenum)	<b>-JB-CHP</b>
Adjustable Pinhole	<b>LRLDQ2619J</b>	55° Beam	<b>-B55</b>	0-10V Dimming (120V/277V)	<b>UE-D10</b>		
Wall Wash	<b>LRLDQ2673</b>			1%, 0-10V Dimming (120V/277V)	<b>UE-D10P1</b>		
				UniDim™ 0-10V, TRIAC/ELV Dimming (120V/277V)	<b>UE-DUN</b>		
<b>Trim Finish</b>		<b>Color Temperature</b>		<b>Lutron EcoSystem</b>	<b>DEC<sup>1</sup></b>	<b>Accessories</b>	
All Black	<b>B</b>	2400K (90 CRI)	<b>-T24</b>	Dali Dimming	<b>-DLI<sup>1</sup></b>	None	<b>Blank</b>
All White	<b>W</b>	2700K (97 CRI)	<b>-T27</b>	Athena Wireless Node (120V)	<b>-AWN</b>	Black Hex-Cell Louver	<b>-LVR</b>
Custom Color	<b>CC</b>	2700K (97 CRI)	<b>-T27-C97</b>	UniSense (120V)	<b>-SUN-RMT<sup>3</sup></b>	Red Lens	<b>/L39<sup>7</sup></b>
		3000K (90 CRI)	<b>-T30</b>	UniSense (120V/277V)	<b>-SUN-RMT-1227<sup>3</sup></b>	Yellow Lens	<b>/L40<sup>7</sup></b>
<b>Lumens</b>		3000K (97 CRI)	<b>-T30-C97</b>	Casambi Wireless Dimming (120V/277V)	<b>-DCSM<sup>1</sup></b>	BlueRed Lens	<b>/L41<sup>7</sup></b>
1000lm (15W)	<b>-L09</b>	3500K (90 CRI)	<b>-T35</b>	BubblyNet Wireless System (120V/277V)	<b>-DBNT<sup>1</sup></b>	Amber Lens	<b>/L42<sup>7</sup></b>
1400lm (22W)	<b>-L14</b>	4000K (90 CRI)	<b>-T40</b>			Green Lens	<b>/L43<sup>7</sup></b>
2400lm (30W)	<b>-L24<sup>1</sup></b>	Dim-to-Warm 1800K-3000K	<b>-TWD<sup>2</sup></b>			Daylight Blue Lens	<b>/L44<sup>7</sup></b>
		RGB+W Control (24VDC)	<b>-RGBWV24<sup>1,5,6</sup></b>			Violet Blue Lens	<b>/L46<sup>7</sup></b>
						Frosted Soft Focus	<b>/L49<sup>7</sup></b>
						Ultra Violet Filter	<b>/L50UV<sup>7</sup></b>
						Micro Prismatic Spread Lens	<b>/L53<sup>7</sup></b>
						Linear Spread Lens	<b>/L55<sup>7</sup></b>

<sup>1</sup> Special order, minimum order. Extended lead time may apply. Consult Factory.  
<sup>2</sup> (-TWD) is only compatible with (-L09) 1000lm (15W).  
<sup>3</sup> (-SUN-RMT) sensor sent with mounting clips for existing ceiling applications.  
<sup>4</sup> Must be selected for Wallwash Trim Style (LRLDQ2673).  
<sup>5</sup> Remote Power Supplies and Control Gear required. Consult Factory for details.  
<sup>6</sup> (-RGBWV24) only available with (-L14) and must be ordered with control option (-PWM).  
<sup>7</sup> Not available with Wall Wash Trim (LRLDQ2673).

Consult factory for emergency battery options.

## SPECIFICATION

### Application

---

Perfect for ambient and task downlighting in low to medium height ceilings and High-End Residential and Commercial applications. Also available in bevel and pinhole options as downlight or with adjustable tilt up to 30° and wall wash.

### Housing

---

Suitable for remodel or new construction installations. Designed to secure to existing sheet rock or panel ceilings up to 1-1/4" thick. For added support in weak ceilings, LHLD26 Frames can be used.

### Thermal Management:

Effective thermal dissipation facilitated by integral cast-aluminum, heat sink design for maximum heat rejection to provide long LED life.

### Junction Box

---

18 gauge pre-wired aluminum Junction Box. 7 cubic-inch for a maximum of (4) #12 AWG wires. (2) 1/2" knock-outs. Remove covers for easy access and ground wire.  
For 1/2" Pipe or Flex-Conduit (LITON# PCT031) Fitting Adaptor should be used.  
Consult Factory.

### Trim Ring

---

Torsion springs hold Square trim and LED Light Engine secure to sheet rock ceiling or Housing Frame.

### Reflector

---

Multifaceted TIR reflector locks into place on LED Light Engine.

### Optics

---

LED Light Engine:

COB (Chip on Board) LED is replaceable via quick disconnect terminal.

Color Temperature:

COLOR TEMP:	2400K	2700K	3000K	3500K	4000K
CRI:	90	90,97	90,97	90	90

Consult factory for availability of other color temperatures.  
3 SDCM Standard. Consult Factory for availability and lead time for 2 SDCM.

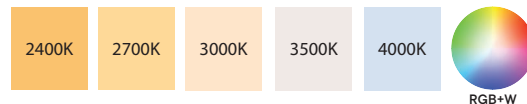

## SPECIFICATION (Continued)

Beam Spread:	Available in 15° (-B15), 24° (-B24), 36° (-B36), 50° (-B50) for Bevel and Pinhole only.
Lumen Maintenance:	Minimum 50,000 hours L70 life based on ANSI TM-21 calculations from LM80 standardized test results.

### Control Options

Remote Driver options available. Consult Factory.

Triac dimming to 7 %, 120V Only

0-10V to 5%, 120V/277V (UE-D10)

0-10V to 1%, 120V/277V (UE-D10P1)

0-10V to 5%, 120V/277V, ELV, and Triac (UE-DUN)

#### ELV and TRIAC Driver 120V (-DIN):

Compatible with electronic low voltage, and 2-Wire incandescent dimmers. Also known as leading edge, Reverse Phase, Forward Phase dimming. Allows smooth dimming down to 5% depending upon the dimmer's limitations.

#### 0-10V Driver 120V/277V (UE-D10):

Compatible with most existing 0-10V systems. Also known as fluorescent or 5-Wire dimming. Allows smooth dimming down to 5% depending upon the dimmer's limitations. Compatible with daylight harvesting controls.

#### UniDim™ Driver 120V/277V (UE-DUN):

All in one ELV and TRIAC phase dimming (120V only), and 0-10V dimming (120V/277V). Works with most 3-Wire ELV, 2-Wire incandescent and 120V/277V 5-Wire 0-10V fluorescent dimmers.

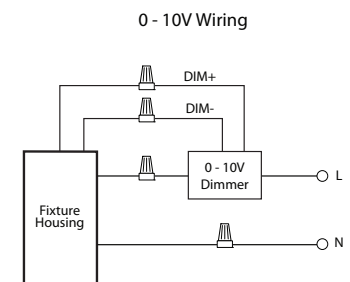
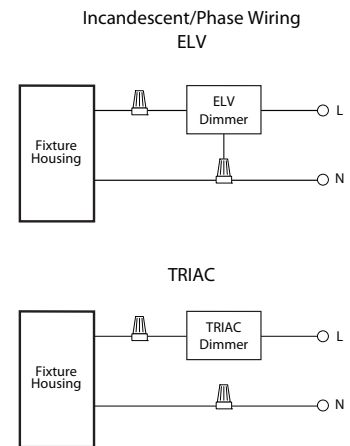
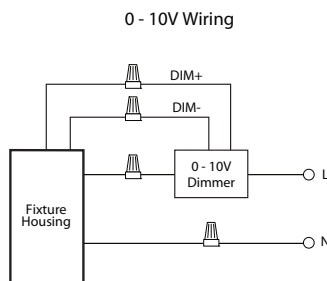
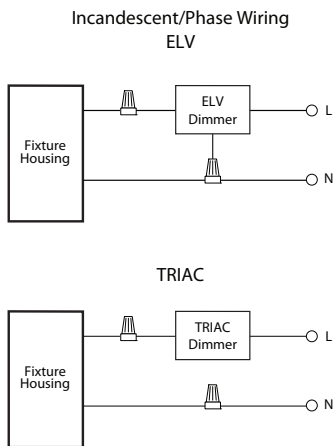

## SPECIFICATION (Continued)

### Housing

**LHLD26-FRM**  
New Construction

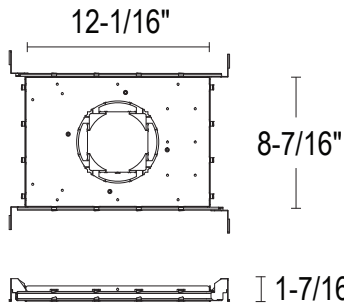

**LHLD26IC-FRM**  
IC Box

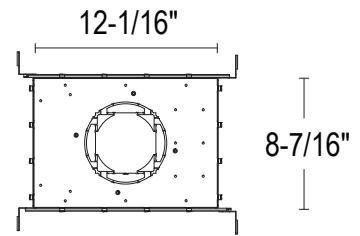

**LHFRLD26**  
Fire-Rated Housing

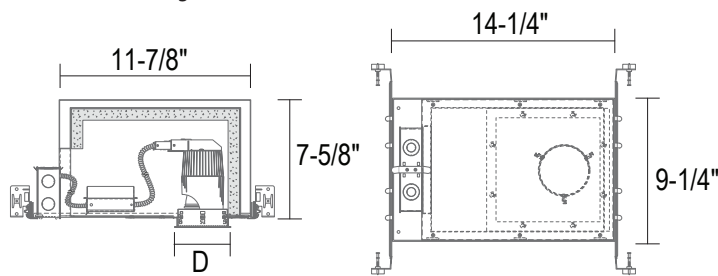

D: Ceiling Cut-out 3" Max

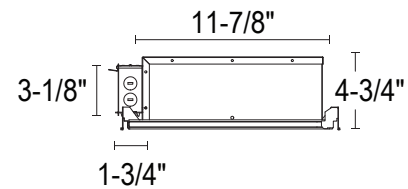
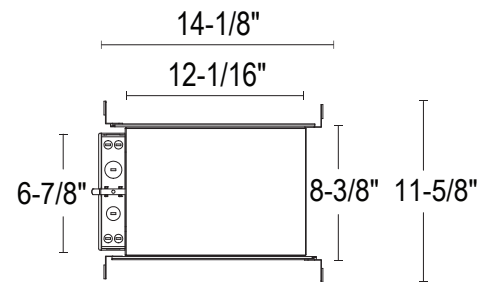

## Unisense<sup>™</sup> PROGRAMMABLE MOTION + DAYLIGHT (-SUN-INT)

- Microwave and PIR (Passive Infrared) sensors depending on option
- Daylight harvesting
- Dusk/dawn sensing capabilities
- Motion Sensor

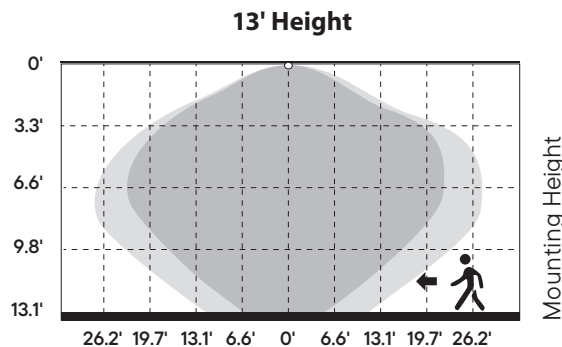

13.1 ft max. distance with 100% sensitivity

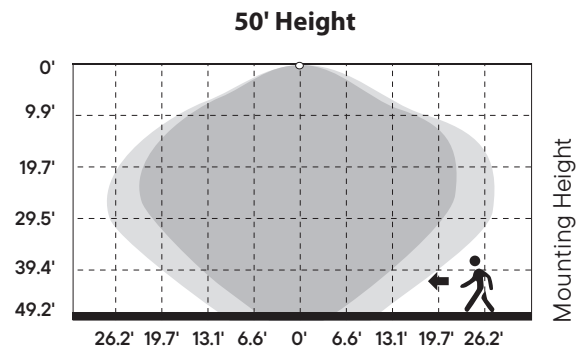

49.2 ft max. distance with 100% sensitivity

Well Detected Area

Possibly Detected Area



## SPECIFICATION (Continued)

### Finishes

---

Reflectors and trim rings are available in powder coated all Black (B) or all White (W) in a die-cast one piece design. Consult Factory for Custom Color RAL finishes. (Charges may apply).

### Certifications and Listings

---

ETL/cETL listed to UL1598 and UL8750. Suitable for damp and wet locations. NYC approved: Calendar #41937. CCEA (City of Chicago Environmental Air) Certified: Conforms to CCEA-200 with Section 18-27-300.22 and special requirements Section 14-20-210C-4.

### Caution

---

LITON recommends use of surge protectors on the power entering LED Housings. Surge damage is not covered by warranty. (+1KV). Fixtures must be grounded in accordance with national, state and/or local electrical codes. Failure to do so may result in serious personal injury.

### Warranty

---

Covered by a 5-Year Warranty to be free of defects in materials and craftsmanship. Recommended for applications where ambient temperatures do not exceed 35°C (95°F). Installations exceeding this temperature will result in reduced LED lamp life and a voided warranty.

### Optional Frames & Accessories

---

**LHLD26-FRM** - New Construction Frame. Suitable for new construction and remodel installations. Adjusts up to 1" ceiling thickness. Supplied with (2) 24" adjustable hanger bars with nail-less install 3/4" serrated barbed studs for mounting in wood joists.

**LHLD26IC-FRM** - New Construction IC Frame. Rated for direct contact with low to medium density loosefill blown and rolled insulation. Adjusts up to 1" ceiling thickness. Supplied with (2) 24" adjustable hanger bars with nail-less install 3/4" serrated barbed studs for mounting in wood joists.

**LHFRLD26** - Suitable for new construction. Adjusts up to 1" ceiling thickness. Supplied with (2) 24" adjustable hanger bars with nail-less install 3/4" serrated barbed studs for mounting in wood joists. Stops the progress of an active fire. Meets the fire-stop capabilities of a typical 5/8" gypsum board (drywall) barrier. Eliminates the requirement to specify more expensive fire-rated materials or the use of manually constructed drywall enclosures. Patented dual-layer housing is constructed of 20-gauge aluminum designed to maintain the continuity of fire-rated ceiling assemblies, subject to UL classified L500 series fire rated assemblies rated for 1 hour.

### Quick Ship Items

---

LRLDQ2621B-L09-B25-T30-DIN	LRLDQ2621W-L09-B25-T30-DIN	LRLDQ2621JB-L09-B25-T30-DIN	LRLDQ2621JW-L09-B25-T30-DIN
LRLDQ2621B-L09-B35-T30-DIN	LRLDQ2621W-L09-B35-T30-DIN	LRLDQ2621JB-L09-B35-T30-DIN	LRLDQ2621JW-L09-B35-T30-DIN
LRLDQ2621B-L09-B45-T30-DIN	LRLDQ2621W-L09-B45-T30-DIN	LRLDQ2621JB-L09-B45-T30-DIN	LRLDQ2621JW-L09-B45-T30-DIN
LRLDQ2621B-L09-B55-T30-DIN	LRLDQ2621W-L09-B55-T30-DIN	LRLDQ2621JB-L09-B55-T30-DIN	LRLDQ2621JW-L09-B55-T30-DIN

PHOTOMETRY - DOWNLIGHT & ADJUSTABLE (Data also applies for LRLDQ2621J, LRXLDQ2621, LRXLDQ2621J)

**LRLDQ2621W-L24-B25-T30UE-D10** (2400lm, 30W, 25°, 3000K)

System Power: 30.3W  
 Test Date: 03/2025  
 Beam Angle 50%: 25.9°  
 Field Angle 10%: 44.5°  
 Color Temperature: 3000K  
 CRI: 90  
 Lumens Delivered: 3534.5  
 CBCP: 11065.6  
 Power Factor: >0.90

MULTIPLIERS	
LUMEN OUTPUT	
1000lm (-L09):	0.38
1400lm (-L14):	0.58
<b>2400lm (-L24):</b>	<b>1.00</b>
COLOR TEMPERATURE	
2700K:	0.79
<b>3000K:</b>	<b>1.00</b>
3500K:	1.02
4000K:	1.03
CRI	
<b>90 CRI:</b>	<b>1.00</b>
97 CRI:	0.90

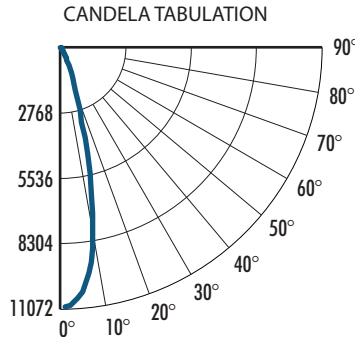

FOOTCANDLE DISTRIBUTION		
Height	Beam Diameter	FC
10.0'	4.60'	110.66
20.0'	9.20'	27.66
30.0'	13.80'	12.30
50.0'	22.99'	4.43
73.0'	33.57'	2.08

**LRLDQ2621W-L24-B35-T30UE-D10** (2400lm, 30W, 35°, 3000K)

System Power: 30.3W  
 Test Date: 03/2025  
 Beam Angle 50%: 33.3°  
 Field Angle 10%: 51.2°  
 Color Temperature: 3000K  
 CRI: 90  
 Lumens Delivered: 3534.5  
 CBCP: 9560.7  
 Power Factor: >0.90

MULTIPLIERS	
LUMEN OUTPUT	
1000lm (-L09):	0.38
1400lm (-L14):	0.58
<b>2400lm (-L24):</b>	<b>1.00</b>
COLOR TEMPERATURE	
2700K:	0.79
<b>3000K:</b>	<b>1.00</b>
3500K:	1.02
4000K:	1.03
CRI	
<b>90 CRI:</b>	<b>1.00</b>
97 CRI:	0.90

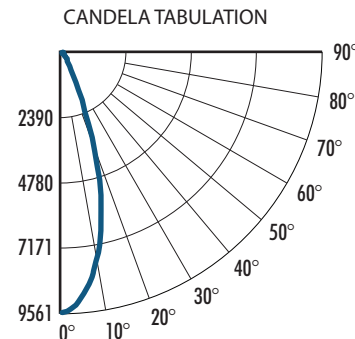

FOOTCANDLE DISTRIBUTION		
Height	Beam Diameter	FC
10.0'	5.98'	95.49
20.0'	11.96'	23.87
30.0'	17.94'	10.61
50.0'	29.91'	3.82
68.0'	40.67'	2.07

**LRLDQ2621W-L24-B45-T30UE-D10** (2400lm, 30W, 45°, 3000K)

System Power: 30.3W  
 Test Date: 03/2025  
 Beam Angle 50%: 45.9°  
 Field Angle 10%: 64.3°  
 Color Temperature: 3000K  
 CRI: 90  
 Lumens Delivered: 3534.5  
 CBCP: 5761.1  
 Power Factor: >0.90

MULTIPLIERS	
LUMEN OUTPUT	
1000lm (-L09):	0.38
1400lm (-L14):	0.58
<b>2400lm (-L24):</b>	<b>1.00</b>
COLOR TEMPERATURE	
2700K:	0.79
<b>3000K:</b>	<b>1.00</b>
3500K:	1.02
4000K:	1.03
CRI	
<b>90 CRI:</b>	<b>1.00</b>
97 CRI:	0.90

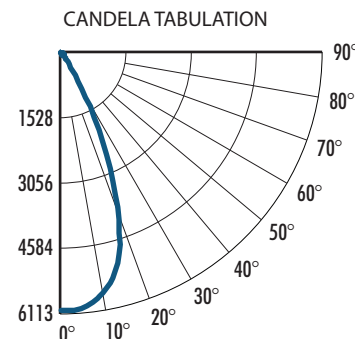

FOOTCANDLE DISTRIBUTION		
Height	Beam Diameter	FC
10.0'	8.47'	57.58
20.0'	16.94'	14.40
30.0'	25.41'	6.40
40.0'	33.88'	3.60
53.0'	44.89'	2.05

**LRLDQ2621W-L24-B55-T30UE-D10** (2400lm, 30W, 55°, 3000K)

System Power: 30.3W  
 Test Date: 03/2025  
 Beam Angle 50%: 53.3°  
 Field Angle 10%: 73.5°  
 Color Temperature: 3000K  
 CRI: 90  
 Lumens Delivered: 3534.5  
 CBCP: 4148.8  
 Power Factor: >0.90

MULTIPLIERS	
LUMEN OUTPUT	
1000lm (-L09):	0.38
1400lm (-L14):	0.58
<b>2400lm (-L24):</b>	<b>1.00</b>
COLOR TEMPERATURE	
2700K:	0.79
<b>3000K:</b>	<b>1.00</b>
3500K:	1.02
4000K:	1.03
CRI	
<b>90 CRI:</b>	<b>1.00</b>
97 CRI:	0.90

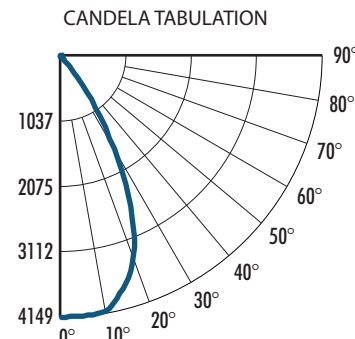

FOOTCANDLE DISTRIBUTION		
Height	Beam Diameter	FC
10.0'	10.04'	41.27
20.0'	20.07'	10.32
30.0'	30.11'	4.59
40.0'	40.15'	2.58
45.0'	45.17'	2.04

2025.06.02

PHOTOMETRY - DOWNLIGHT & ADJUSTABLE (Data also applies for LRLDQ2619J, LRXLDQ2619, LRXLDQ2619J)

**LRLDQ2619W-L24-B25-T30UE-D10** (2400lm, 30W, 25°, 3000K)

System Power:	30.3W
Test Date:	03/2025
Beam Angle 50%:	25.8°
Field Angle 10%:	43.9°
Color Temperature:	3000K
CRI:	90
Lumens Delivered:	3534.5
CBCP:	11260.6
Power Factor:	>0.90

MULTIPLIERS	
LUMEN OUTPUT	
1000lm (-L09) :	0.38
1400lm (-L14) :	0.58
<b>2400lm (-L24) :</b>	<b>1.00</b>
COLOR TEMPERATURE	
2700K :	0.79
<b>3000K :</b>	<b>1.00</b>
3500K :	1.02
4000K :	1.03
CRI	
<b>90 CRI :</b>	<b>1.00</b>
97 CRI :	0.90

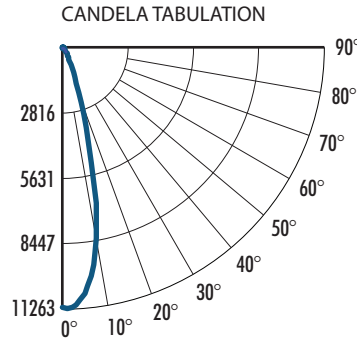

FOOTCANDLE DISTRIBUTION		
Height	Beam Diameter	FC
10.0'	4.58'	112.31
20.0'	9.16'	28.08
30.0'	13.74'	12.48
50.0'	22.90'	4.49
74.0'	33.90'	2.05

**LRLDQ2619W-L24-B35-T30UE-D10** (2400lm, 30W, 35°, 3000K)

System Power:	30.3W
Test Date:	03/2025
Beam Angle 50%:	33.2°
Field Angle 10%:	50.9°
Color Temperature:	3000K
CRI:	90
Lumens Delivered:	3534.5
CBCP:	9571.9
Power Factor:	>0.90

MULTIPLIERS	
LUMEN OUTPUT	
1000lm (-L09) :	0.38
1400lm (-L14) :	0.58
<b>2400lm (-L24) :</b>	<b>1.00</b>
COLOR TEMPERATURE	
2700K :	0.79
<b>3000K :</b>	<b>1.00</b>
3500K :	1.02
4000K :	1.03
CRI	
<b>90 CRI :</b>	<b>1.00</b>
97 CRI :	0.90

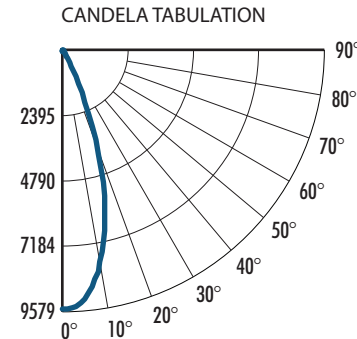

FOOTCANDLE DISTRIBUTION		
Height	Beam Diameter	FC
10.0'	5.96'	95.56
20.0'	11.92'	23.89
30.0'	17.89'	10.62
50.0'	29.81'	3.82
68.0'	40.54'	2.07

**LRLDQ2619W-L24-B45-T30UE-D10** (2400lm, 30W, 45°, 3000K)

System Power:	30.3W
Test Date:	03/2025
Beam Angle 50%:	45.8°
Field Angle 10%:	64.0°
Color Temperature:	3000K
CRI:	90
Lumens Delivered:	3534.5
CBCP:	5787.2
Power Factor:	>0.90

MULTIPLIERS	
LUMEN OUTPUT	
1000lm (-L09) :	0.38
1400lm (-L14) :	0.58
<b>2400lm (-L24) :</b>	<b>1.00</b>
COLOR TEMPERATURE	
2700K :	0.79
<b>3000K :</b>	<b>1.00</b>
3500K :	1.02
4000K :	1.03
CRI	
<b>90 CRI :</b>	<b>1.00</b>
97 CRI :	0.90

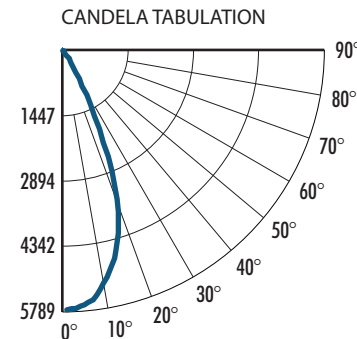

FOOTCANDLE DISTRIBUTION		
Height	Beam Diameter	FC
10.0'	8.45'	57.80
20.0'	16.90'	14.45
30.0'	25.34'	6.42
40.0'	33.79'	3.61
53.0'	44.78'	2.06

**LRLDQ2619W-L24-B55-T30UE-D10** (2400lm, 30W, 55°, 3000K)

System Power:	30.3W
Test Date:	03/2025
Beam Angle 50%:	53.3°
Field Angle 10%:	74.2°
Color Temperature:	3000K
CRI:	90
Lumens Delivered:	3534.5
CBCP:	4214.7
Power Factor:	>0.90

MULTIPLIERS	
LUMEN OUTPUT	
1000lm (-L09) :	0.38
1400lm (-L14) :	0.58
<b>2400lm (-L24) :</b>	<b>1.00</b>
COLOR TEMPERATURE	
2700K :	0.79
<b>3000K :</b>	<b>1.00</b>
3500K :	1.02
4000K :	1.03
CRI	
<b>90 CRI :</b>	<b>1.00</b>
97 CRI :	0.90

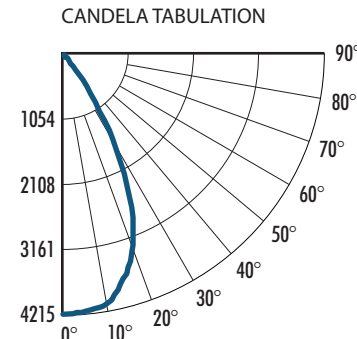

FOOTCANDLE DISTRIBUTION		
Height	Beam Diameter	FC
10.0'	10.04'	42.02
20.0'	20.07'	10.51
30.0'	30.11'	4.67
40.0'	40.15'	2.63
45.0'	45.17'	2.08

2025.06.02

## PHOTOMETRY - WALL WASH (Data also applies for LRLDQ2673)

### LRLDQ2673W-L24-T30UE-D10 (2400lm, 30W, Wall Wash, 3000K)

System Power: 30.3W  
 Test Date: 03/2025  
 Color Temperature: 3000K  
 CRI: 90  
 Lumens Delivered: 3847.1  
 CBCP: 2652.5  
 Power Factor: >0.90

MULTIPLIERS	
LUMEN OUTPUT	
1000lm (-L09) :	0.38
1400lm (-L14) :	0.58
<b>2400lm (-L24) :</b>	<b>1.00</b>
COLOR TEMPERATURE	
2700K :	0.79
<b>3000K :</b>	<b>1.00</b>
3500K :	1.02
4000K :	1.03
CRI	
<b>90 CRI :</b>	<b>1.00</b>
97 CRI :	0.90

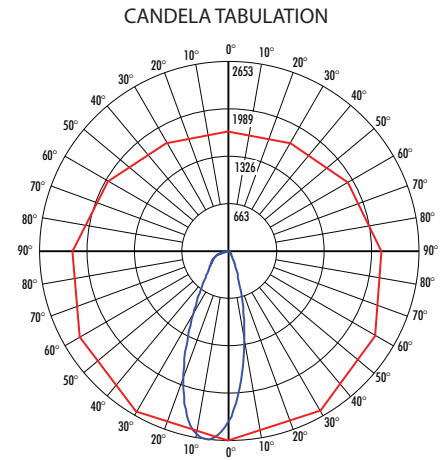

## PERFORMANCE DATA

### LUMINAIRE SPACED 3.5' FROM WALL

#### Footcandles On Wall

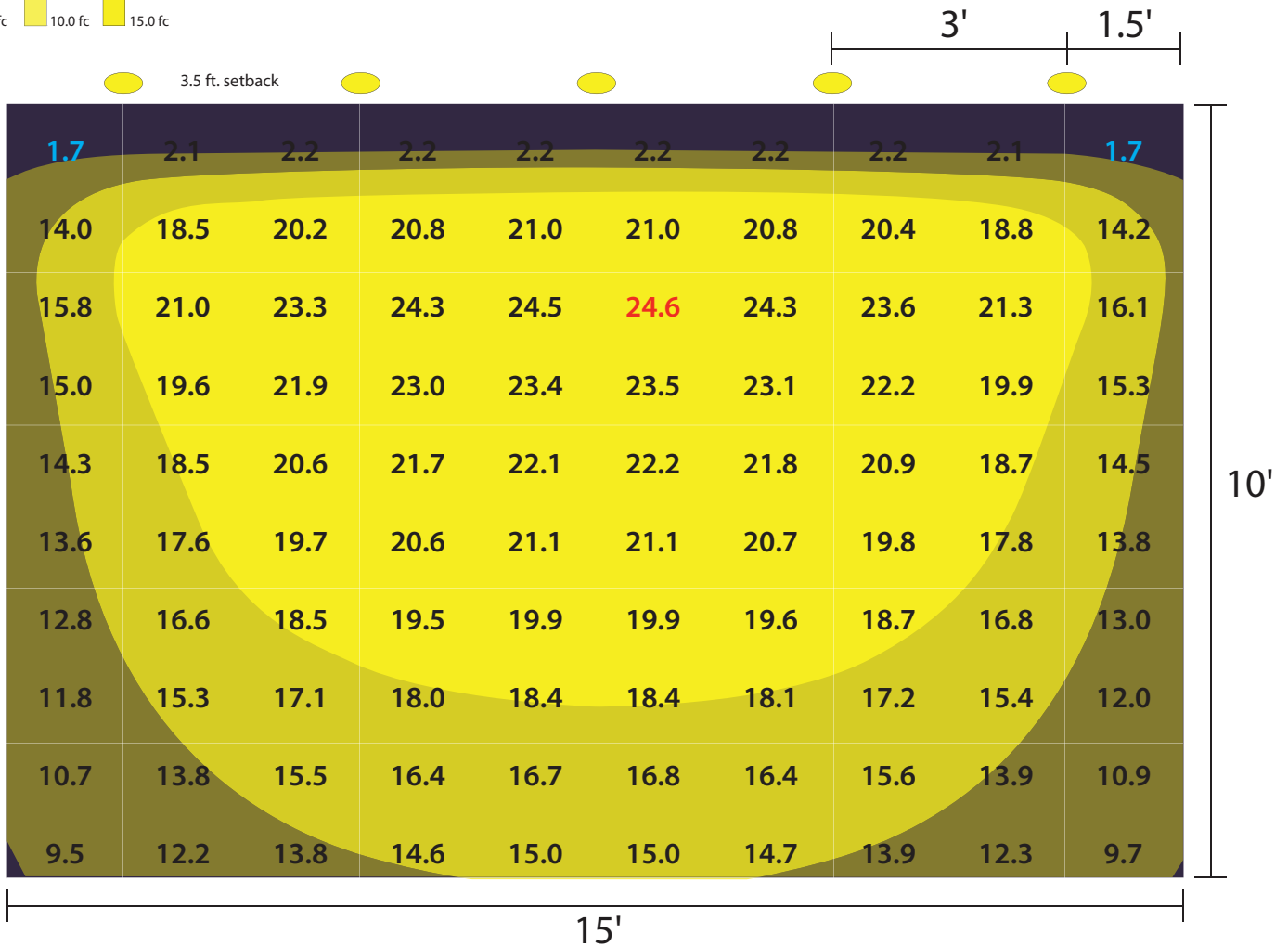

2025.06.02