

LRS14 - FROSTED DOME W/ REFLECTOR

6" LINE VOLTAGE TRIMS

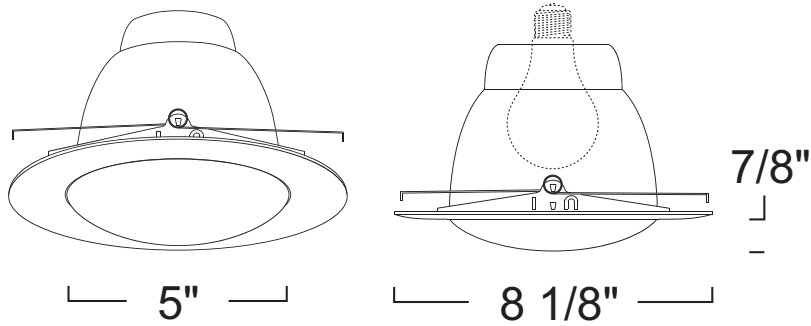

SPECIFICATION

120V/CFL 60W Max A19/PAR20 MED E26

Application: The Reflector Lensed trim optimizes lumen output, ensuring that all stray light is directed downward. Each shower trim has a clear reflector mounted inside the trim to create a more intense and focused light.









Mounting: Steel pressure springs mounted on trim to ensure positive retention inside housing.

Inner Reflector: Comes standard in a spun specular inner reflector. Only available in Clear.

Ring Finish: Die-Formed Aluminum Trim Ring Available in White (Plastic), Chrome, Natural, Copper and Mocha.

Label: UL Listed, cETL Listed

COMPATIBILITY

 LH27 STANDARD SHALLOW E26 HOUSING	 LH7 STANDARD E26 HOUSING	 LH7R REMODEL E26 HOUSING
 LH7IC 100W IC E26 HOUSING	 LH276IC IC CFL HOUSING 1-LAMP	 LH276RICA REMODEL IC AIRTIGHT CFL HOUSING
 LH276R REMODEL CFL HOUSING (ELECTRONIC)	 LH27R REMODEL SHALLOW E2 HOUSING	

Note: Wattage limitations on compatible items must be met.

2016.8.26

FEATURE:



ORDERING EXAMPLE : LRS14MC-WL

LRS14	INNER REFLECTOR	RING FINISH	RATING
LRS14	Blank :Clear	PW :White (Plastic) MC :Chrome MN :Natural MCO :Copper MO :Mocha	Blank :Damp Location -WL :Wet Location

ID#: 43