

LRXLD26: 2.5" GEN2 P-SERIES

ROUND APERTURE TRIMLESS 600LM-2400LM (10W/15W/22W/30W)

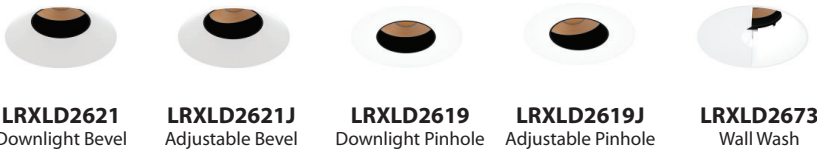
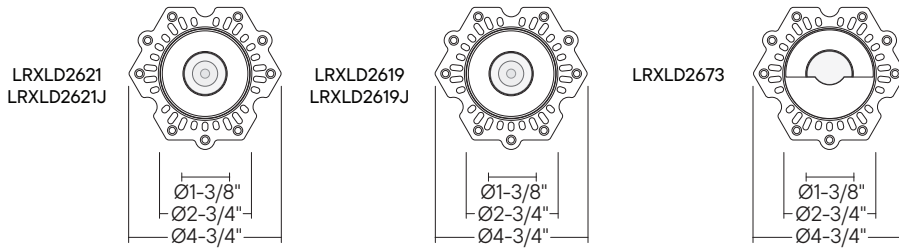
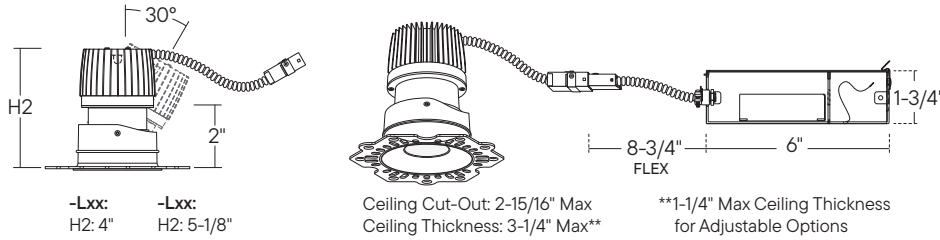

- Up to 30W, 2400lm
- Multiple Beam Spreads and Color Temperatures including Dim to Warm
- One Piece Die-Cast Construction
- Larger Aperture for Easy Installation
- Airtight Lens Wet Location Option
- Type IC Option Available
- Multiple Wireless Control Options
- Wood Installation Available

| Trim | Reflector Insert Finish | Lumens | Beam Spread | Color Temperature | Control | Rating | Accessories |
|--------------------------------------|--------------------------------|---------------------------------|--|----------------------------|--------------------------------|-------------------|-------------|
| Trim Style | Beam Spread | Color Temperature | Control | Rating | Accessories | | |
| TRIMLESS | Wall Wash only | Blank ⁴ | Non-Dimming (120V) | Blank | None | Blank | |
| Downlight Bevel LRXLD2621 | 25° Beam | -B25 | PWM Dimming (24VDC) | -PWM | Airtight Lensed (Wet Location) | -WL | |
| Adjustable Bevel LRXLD2621J | 35° Beam | -B35 | TRIAC/ELV Dimming (120V) | -DIN | Wood Installation | -WD ⁷ | |
| Downlight Pinhole LRXLD2619 | 45° Beam | -B54 | 0-10V Dimming (120V/277V) | UE-D10 | 4" J-Box (Chicago Plenum) | -JB-CHP | |
| Adjustable Pinhole LRXLD2619J | 55° Beam | -B55 | 1%, 0-10V Dimming (120V/277V) | UE-D10P1 | | | |
| Wall Wash LRXLD2673 | | | UniDim™ 0-10V, TRIAC/ELV Dimming (120V/277V) | UE-DUN | | | |
| Reflector Insert Finish | Color Temperature | | Lutron EcoSystem | DEC ¹ | Accessories | | |
| All Black B | 2400K (90 CRI) -T24 | | Dali Dimming | -DLI ¹ | None | Blank | |
| All White W | 2700K (97 CRI) -T27 | | Athena Wireless Node (120V) | -AWN | Black Hex-Cell Louver | -LVR | |
| Custom Color CC | 2700K (97 CRI) -T27-C97 | | UniSense (120V) | -SUN-RMT ³ | Red Lens | /L39 ⁸ | |
| Lumens | 3000K (90 CRI) -T30 | | UniSense (120V/277V) | -SUN-RMT-1227 ³ | Yellow Lens | /L40 ⁸ | |
| 1000lm (15W) -L09 | 3000K (97 CRI) -T30-C97 | | Casambi Wireless Dimming (120V/277V) | -DCSM ¹ | BlueRed Lens | /L41 ⁸ | |
| 1400lm (22W) -L14 | 3500K (90 CRI) -T35 | | BubblyNet Wireless System (120V/277V) | -DBNT ¹ | Amber Lens | /L42 ⁸ | |
| 2400lm (30W) -L24¹ | 4000K (90 CRI) -T40 | | | | Green Lens | /L43 ⁸ | |
| | Dim-to-Warm 1800K-3000K | -TWD² | | | Daylight Blue Lens | /L44 ⁸ | |
| | RGB+W Control (24VDC) | -RGBWV24^{1,5,6} | | | Violet Blue Lens | /L46 ⁸ | |

¹ Special order, minimum order. Extended lead time may apply. Consult Factory.
² (-TWD) is only compatible with (-L09) 1000lm (15W).
³ (-SUN-RMT) sensor sent with mounting clips for existing ceiling applications.
⁴ Must be selected for Wallwash Trim Style.
⁵ Remote Power Supplies and Control Gear required. Consult Factory for details.
⁶ (-RGBWV24) only available with (-L14) and must be ordered with control option (-PWM).
⁷ Wood Ceiling Installation requires above-ceiling access.
⁸ Not available with Wall Wash Trim (LRXLDQ2673).

Consult factory for emergency battery options.

SPECIFICATION

Application

Perfect for ambient and task downlighting in low to medium height ceilings and High-End Residential and Commercial applications. Also available in bevel and pinhole options as downlight or with adjustable tilt up to 30° and wall wash.

Housing

Suitable for remodel or new construction installations. Designed to secure to existing sheet rock or panel ceilings up to 1-1/4" thick. For added support in weak ceilings, LHLD26 Frames can be used.

Thermal Management:

Effective thermal dissipation facilitated by integral cast-aluminum, heat sink design for maximum heat rejection to provide long LED life.

Junction Box

18 gauge pre-wired aluminum Junction Box. 7 cubic-inch for a maximum of (4) #12 AWG wires. (2) 1/2" knock-outs. Remove covers for easy access and ground wire. For 1/2" Pipe or Flex-Conduit (LITON# PCT031) Fitting Adaptor should be used. Consult Factory.

Trim Ring

Reflector and die-cast aluminum trim secure to sheet rock ceiling or Housing Frame with drywall screws secured to trim ring.

Reflector

Multifaceted TIR reflector locks into place on LED Light Engine.

Optics

LED Light Engine: COB (Chip on Board) LED is replaceable via quick disconnect terminal.

Color Temperature: COLOR TEMP: 2400K 2700K 3000K 3500K 4000K
CRI: 90 90,97 90,97 90 90

Consult factory for availability of other color temperatures.
3 SDCM Standard. Consult Factory for availability and lead time for 2 SDCM.

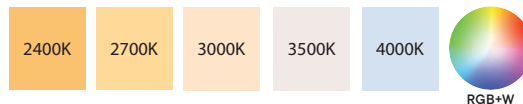

SPECIFICATION (Continued)

| | |
|--------------------|---|
| Beam Spread: | Available in 15° (-B15), 24° (-B24), 36° (-B36), 50° (-B50) for Bevel and Pinhole only. |
| Lumen Maintenance: | Minimum 50,000 hours L70 life based on ANSI TM-21 calculations from LM80 standardized test results. |

Control Options

Remote Driver options available. Consult Factory.

Triac dimming to 7 %, 120V Only

0-10V to 5%, 120V/277V (UE-D10)

0-10V to 1%, 120V/277V (UE-D10P1)

0-10V to 5%, 120V/277V, ELV, and Triac (UE-DUN)

ELV and TRIAC Driver 120V (-DIN):

Compatible with electronic low voltage, and 2-Wire incandescent dimmers. Also known as leading edge, Reverse Phase, Forward Phase dimming. Allows smooth dimming down to 5% depending upon the dimmer's limitations.

0-10V Driver 120V/277V (UE-D10):

Compatible with most existing 0-10V systems. Also known as fluorescent or 5-Wire dimming. Allows smooth dimming down to 5% depending upon the dimmer's limitations. Compatible with daylight harvesting controls.

UniDim™ Driver 120V/277V (UE-DUN):

All in one ELV and TRIAC phase dimming (120V only), and 0-10V dimming (120V/277V). Works with most 3-Wire ELV, 2-Wire incandescent and 120V/277V 5-Wire 0-10V fluorescent dimmers.

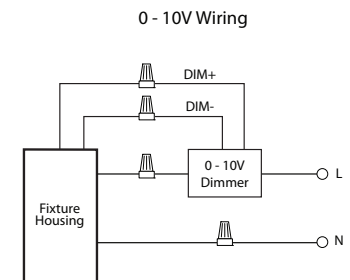
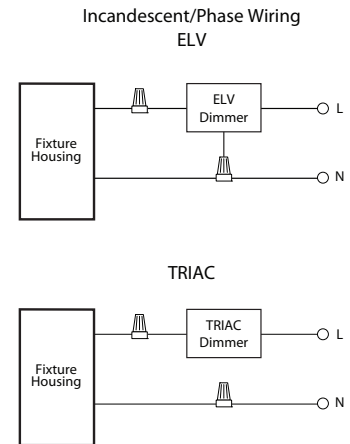
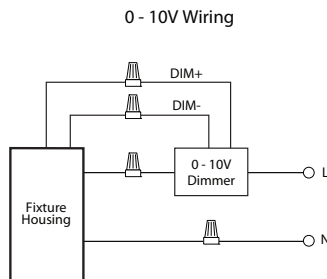
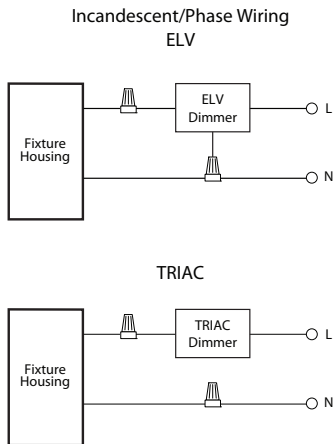

SPECIFICATION (Continued)

Housing

LHLD26-FRM
New Construction

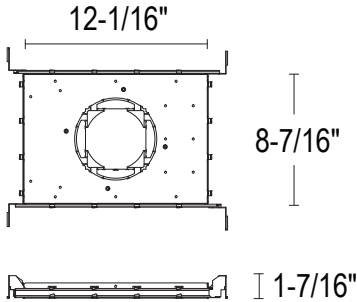

LHLD26IC-FRM
IC Box

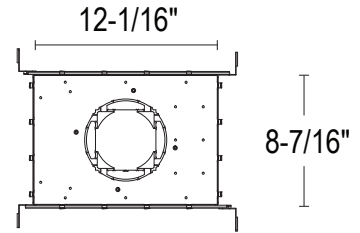

LHFRLD26
Fire-Rated Housing

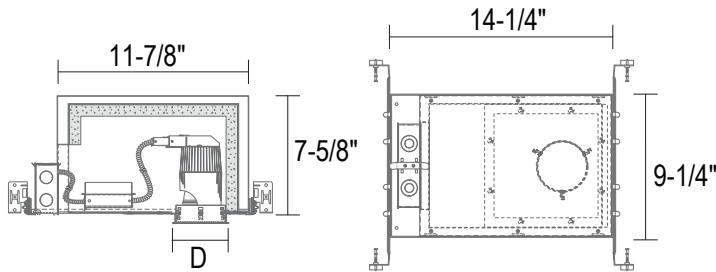

D: Ceiling Cut-out 3" Max

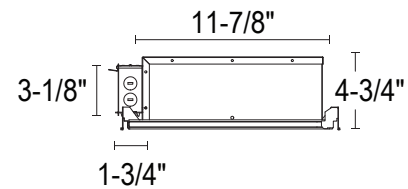
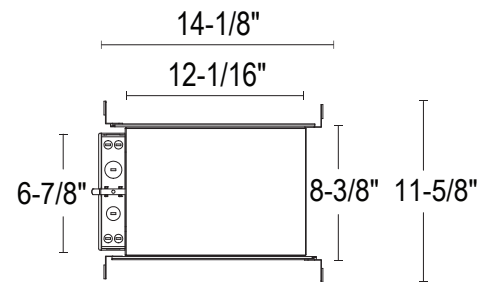

Unisense[™] PROGRAMMABLE MOTION + DAYLIGHT (-SUN-INT)

- Microwave and PIR (Passive Infrared) sensors depending on option
- Daylight harvesting
- Dusk/dawn sensing capabilities
- Motion Sensor

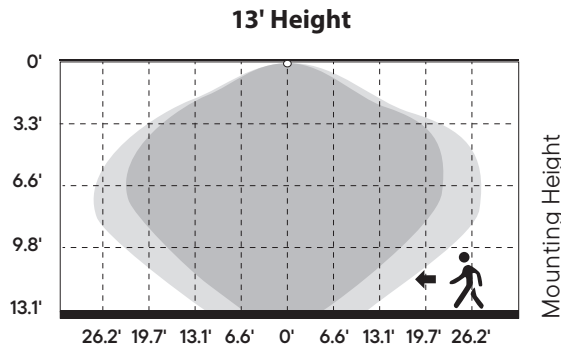

13.1 ft max. distance with 100% sensitivity

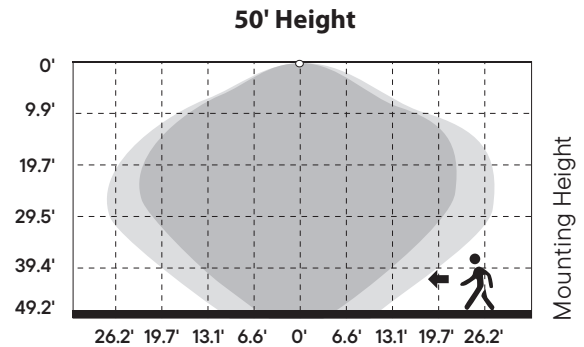

49.2 ft max. distance with 100% sensitivity

Well Detected Area

Possibly Detected Area



SPECIFICATION (Continued)

Finishes

Reflectors and trim rings are available in powder coated all Black (B) or all White (W) in a die-cast one piece design. Consult Factory for Custom Color RAL finishes. (Charges may apply).

Certifications and Listings

ETL/cETL listed to UL1598 and UL8750. Suitable for damp and wet locations. NYC approved: Calendar #41937. CCEA (City of Chicago Environmental Air) Certified: Conforms to CCEA-200 with Section 18-27-300.22 and special requirements Section 14-20-210C-4.

Caution

LITON recommends use of surge protectors on the power entering LED Housings. Surge damage is not covered by warranty. (+1KV). Fixtures must be grounded in accordance with national, state and/or local electrical codes. Failure to do so may result in serious personal injury.

Warranty

Covered by a 5-Year Warranty to be free of defects in materials and craftsmanship. Recommended for applications where ambient temperatures do not exceed 35°C (95°F). Installations exceeding this temperature will result in reduced LED lamp life and a voided warranty.

Optional Frames & Accessories

LHLD26-FRM - New Construction Frame. Suitable for new construction and remodel installations. Adjusts up to 1" ceiling thickness. Supplied with (2) 24" adjustable hanger bars with nail-less install 3/4" serrated barbed studs for mounting in wood joists.

LHLD26IC-FRM - New Construction IC Frame. Rated for direct contact with low to medium density loosefill blown and rolled insulation. Adjusts up to 1" ceiling thickness. Supplied with (2) 24" adjustable hanger bars with nail-less install 3/4" serrated barbed studs for mounting in wood joists.

LHFRLD26 - Suitable for new construction. Adjusts up to 1" ceiling thickness. Supplied with (2) 24" adjustable hanger bars with nail-less install 3/4" serrated barbed studs for mounting in wood joists. Stops the progress of an active fire. Meets the fire-stop capabilities of a typical 5/8" gypsum board (drywall) barrier. Eliminates the requirement to specify more expensive fire-rated materials or the use of manually constructed drywall enclosures. Patented dual-layer housing is constructed of 20-gauge aluminum designed to maintain the continuity of fire-rated ceiling assemblies, subject to UL classified L500 series fire rated assemblies rated for 1 hour.

Quick Ship Items

| | | | |
|----------------------------|----------------------------|-----------------------------|-----------------------------|
| LRXLD2621B-L09-B25-T30-DIN | LRXLD2621W-L09-B25-T30-DIN | LRXLD2621JB-L09-B25-T30-DIN | LRXLD2621JW-L09-B25-T30-DIN |
| LRXLD2621B-L09-B35-T30-DIN | LRXLD2621W-L09-B35-T30-DIN | LRXLD2621JB-L09-B35-T30-DIN | LRXLD2621JW-L09-B35-T30-DIN |
| LRXLD2621B-L09-B45-T30-DIN | LRXLD2621W-L09-B45-T30-DIN | LRXLD2621JB-L09-B45-T30-DIN | LRXLD2621JW-L09-B45-T30-DIN |
| LRXLD2621B-L09-B55-T30-DIN | LRXLD2621W-L09-B55-T30-DIN | LRXLD2621JB-L09-B55-T30-DIN | LRXLD2621JW-L09-B55-T30-DIN |

PHOTOMETRY - DOWNLIGHT & ADJUSTABLE (Data also applies for LRXLD2621J, LRLD2621, LRLD2621J)

LRXLD2621W-L24-B25-T30UE-D10 (2400lm, 30W, 25°, 3000K)

| | |
|--------------------|---------|
| System Power: | 30.3W |
| Test Date: | 03/2025 |
| Beam Angle 50%: | 26.2° |
| Field Angle 10%: | 45.8° |
| Color Temperature: | 3000K |
| CRI: | 90 |
| Lumens Delivered: | 3410.2 |
| CBCP: | 12188.4 |
| Power Factor: | >0.90 |

| MULTIPLIERS | |
|------------------------|-------------|
| LUMEN OUTPUT | |
| 1000lm (-L09) : | 0.38 |
| 1400lm (-L14) : | 0.58 |
| 2400lm (-L24) : | 1.00 |
| COLOR TEMPERATURE | |
| 2700K : | 0.79 |
| 3000K : | 1.00 |
| 3500K : | 1.02 |
| 4000K : | 1.03 |
| CRI | |
| 90 CRI : | 1.00 |
| 97 CRI : | 0.90 |

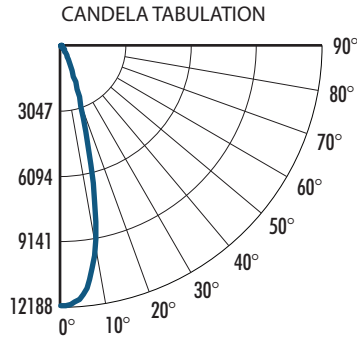

| FOOTCANDLE DISTRIBUTION | | |
|-------------------------|---------------|--------|
| Height | Beam Diameter | FC |
| 10.0' | 4.65' | 121.88 |
| 20.0' | 9.31' | 30.47 |
| 30.0' | 13.96' | 13.54 |
| 50.0' | 23.27' | 4.88 |
| 78.0' | 36.30' | 2.00 |

LRXLD2621W-L24-B35-T30UE-D10 (2400lm, 30W, 35°, 3000K)

| | |
|--------------------|---------|
| System Power: | 30.3W |
| Test Date: | 03/2025 |
| Beam Angle 50%: | 32.8° |
| Field Angle 10%: | 50.2° |
| Color Temperature: | 3000K |
| CRI: | 90 |
| Lumens Delivered: | 2797 |
| CBCP: | 10304.0 |
| Power Factor: | >0.90 |

| MULTIPLIERS | |
|------------------------|-------------|
| LUMEN OUTPUT | |
| 1000lm (-L09) : | 0.38 |
| 1400lm (-L14) : | 0.58 |
| 2400lm (-L24) : | 1.00 |
| COLOR TEMPERATURE | |
| 2700K : | 0.79 |
| 3000K : | 1.00 |
| 3500K : | 1.02 |
| 4000K : | 1.03 |
| CRI | |
| 90 CRI : | 1.00 |
| 97 CRI : | 0.90 |

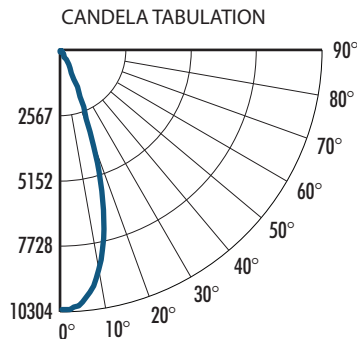

| FOOTCANDLE DISTRIBUTION | | |
|-------------------------|---------------|--------|
| Height | Beam Diameter | FC |
| 10.0' | 5.89' | 102.84 |
| 20.0' | 11.77' | 25.71 |
| 30.0' | 17.66' | 11.43 |
| 50.0' | 29.43' | 4.11 |
| 71.0' | 41.79' | 2.04 |

LRXLD2621W-L24-B45-T30UE-D10 (2400lm, 30W, 45°, 3000K)

| | |
|--------------------|---------|
| System Power: | 30.3W |
| Test Date: | 03/2025 |
| Beam Angle 50%: | 44.3° |
| Field Angle 10%: | 64.7° |
| Color Temperature: | 3000K |
| CRI: | 90 |
| Lumens Delivered: | 3205 |
| CBCP: | 6112.6 |
| Power Factor: | >0.90 |

| MULTIPLIERS | |
|------------------------|-------------|
| LUMEN OUTPUT | |
| 1000lm (-L09) : | 0.38 |
| 1400lm (-L14) : | 0.58 |
| 2400lm (-L24) : | 1.00 |
| COLOR TEMPERATURE | |
| 2700K : | 0.79 |
| 3000K : | 1.00 |
| 3500K : | 1.02 |
| 4000K : | 1.03 |
| CRI | |
| 90 CRI : | 1.00 |
| 97 CRI : | 0.90 |

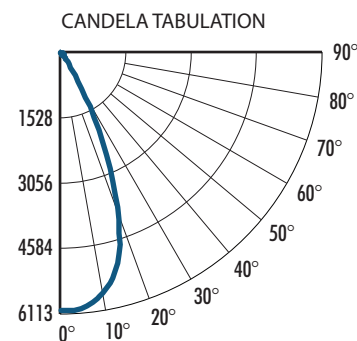

| FOOTCANDLE DISTRIBUTION | | |
|-------------------------|---------------|-------|
| Height | Beam Diameter | FC |
| 10.0' | 8.14' | 61.05 |
| 20.0' | 16.28' | 15.26 |
| 30.0' | 24.42' | 6.78 |
| 40.0' | 32.57' | 3.82 |
| 55.0' | 44.78' | 2.02 |

LRLXD2621W-L24-B55-T30UE-D10 (2400lm, 30W, 55°, 3000K)

| | |
|--------------------|---------|
| System Power: | 30.3W |
| Test Date: | 03/2025 |
| Beam Angle 50%: | 54.0° |
| Field Angle 10%: | 74.4° |
| Color Temperature: | 3000K |
| CRI: | 90 |
| Lumens Delivered: | 2797 |
| CBCP: | 4221.6 |
| Power Factor: | >0.90 |

| MULTIPLIERS | |
|------------------------|-------------|
| LUMEN OUTPUT | |
| 1000lm (-L09) : | 0.38 |
| 1400lm (-L14) : | 0.58 |
| 2400lm (-L24) : | 1.00 |
| COLOR TEMPERATURE | |
| 2700K : | 0.79 |
| 3000K : | 1.00 |
| 3500K : | 1.02 |
| 4000K : | 1.03 |
| CRI | |
| 90 CRI : | 1.00 |
| 97 CRI : | 0.90 |

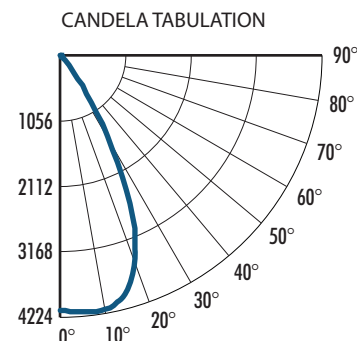

| FOOTCANDLE DISTRIBUTION | | |
|-------------------------|---------------|-------|
| Height | Beam Diameter | FC |
| 10.0' | 10.19' | 41.50 |
| 20.0' | 20.38' | 10.40 |
| 30.0' | 30.57' | 4.62 |
| 40.0' | 40.76' | 2.60 |
| 45.0' | 22.93' | 2.05 |

2025.06.02

PHOTOMETRY - DOWNLIGHT & ADJUSTABLE (Data also applies for LRXLD2619J, LRLD2619, LRLD2619J)

LRLD2619W-L24-B25-T30UE-D10 (2400lm, 30W, 25°, 3000K)

| | |
|--------------------|---------|
| System Power: | 30.3W |
| Test Date: | 03/2025 |
| Beam Angle 50%: | 24.5° |
| Field Angle 10%: | 42.8° |
| Color Temperature: | 3000K |
| CRI: | 90 |
| Lumens Delivered: | 3660.3 |
| CBCP: | 10014.6 |
| Power Factor: | >0.90 |

| MULTIPLIERS | |
|------------------------|-------------|
| LUMEN OUTPUT | |
| 1000lm (-L09) : | 0.38 |
| 1400lm (-L14) : | 0.58 |
| 2400lm (-L24) : | 1.00 |
| COLOR TEMPERATURE | |
| 2700K : | 0.79 |
| 3000K : | 1.00 |
| 3500K : | 1.02 |
| 4000K : | 1.03 |
| CRI | |
| 90 CRI : | 1.00 |
| 97 CRI : | 0.90 |

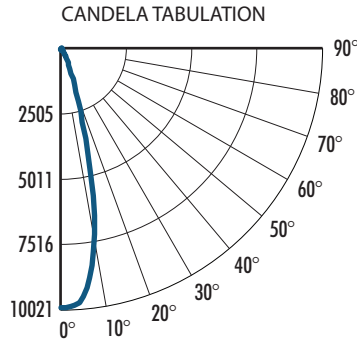

| FOOTCANDLE DISTRIBUTION | | |
|-------------------------|---------------|--------|
| Height | Beam Diameter | FC |
| 10.0' | 4.34' | 100.07 |
| 20.0' | 8.68' | 25.02 |
| 30.0' | 13.03' | 11.12 |
| 50.0' | 21.71' | 4.00 |
| 70.0' | 30.40' | 2.04 |

LRLD2619W-L24-B35-T30UE-D10 (2400lm, 30W, 35°, 3000K)

| | |
|--------------------|---------|
| System Power: | 30.3W |
| Test Date: | 03/2025 |
| Beam Angle 50%: | 31.6° |
| Field Angle 10%: | 49.2° |
| Color Temperature: | 3000K |
| CRI: | 90 |
| Lumens Delivered: | 3660.3 |
| CBCP: | 8159.2 |
| Power Factor: | >0.90 |

| MULTIPLIERS | |
|------------------------|-------------|
| LUMEN OUTPUT | |
| 1000lm (-L09) : | 0.38 |
| 1400lm (-L14) : | 0.58 |
| 2400lm (-L24) : | 1.00 |
| COLOR TEMPERATURE | |
| 2700K : | 0.79 |
| 3000K : | 1.00 |
| 3500K : | 1.02 |
| 4000K : | 1.03 |
| CRI | |
| 90 CRI : | 1.00 |
| 97 CRI : | 0.90 |

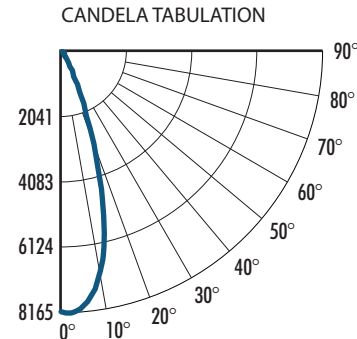

| FOOTCANDLE DISTRIBUTION | | |
|-------------------------|---------------|-------|
| Height | Beam Diameter | FC |
| 10.0' | 5.66' | 87.41 |
| 20.0' | 11.32' | 20.35 |
| 30.0' | 16.98' | 9.05 |
| 50.0' | 28.30' | 3.26 |
| 63.0' | 35.65' | 2.05 |

LRLD2619W-L24-B45-T30UE-D10 (2400lm, 30W, 45°, 3000K)

| | |
|--------------------|----------|
| System Power: | 30.3W |
| Test Date: | 03/2025 |
| Beam Angle 50%: | 43.0° |
| Field Angle 10%: | 63.2° |
| Color Temperature: | 3000K |
| CRI: | 90 |
| Lumens Delivered: | 3660.3 |
| CBCP: | 4872.6++ |
| Power Factor: | >0.90 |

| MULTIPLIERS | |
|------------------------|-------------|
| LUMEN OUTPUT | |
| 1000lm (-L09) : | 0.38 |
| 1400lm (-L14) : | 0.58 |
| 2400lm (-L24) : | 1.00 |
| COLOR TEMPERATURE | |
| 2700K : | 0.79 |
| 3000K : | 1.00 |
| 3500K : | 1.02 |
| 4000K : | 1.03 |
| CRI | |
| 90 CRI : | 1.00 |
| 97 CRI : | 0.90 |

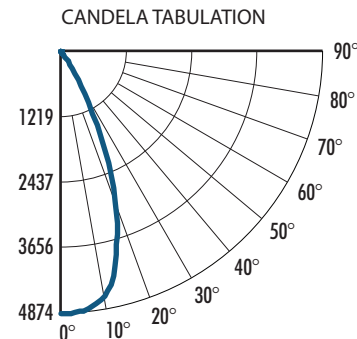

| FOOTCANDLE DISTRIBUTION | | |
|-------------------------|---------------|-------|
| Height | Beam Diameter | FC |
| 10.0' | 7.88' | 48.70 |
| 20.0' | 15.76' | 12.18 |
| 30.0' | 23.63' | 5.41 |
| 40.0' | 31.51' | 3.04 |
| 49.0' | 38.60' | 2.03 |

LRLD2619W-L24-B55-T30UE-D10 (2400lm, 30W, 55°, 3000K)

| | |
|--------------------|---------|
| System Power: | 30.3W |
| Test Date: | 03/2025 |
| Beam Angle 50%: | 53.3° |
| Field Angle 10%: | 72.8° |
| Color Temperature: | 3000K |
| CRI: | 90 |
| Lumens Delivered: | 3660.3 |
| CBCP: | 3302.1 |
| Power Factor: | >0.90 |

| MULTIPLIERS | |
|------------------------|-------------|
| LUMEN OUTPUT | |
| 1000lm (-L09) : | 0.38 |
| 1400lm (-L14) : | 0.58 |
| 2400lm (-L24) : | 1.00 |
| COLOR TEMPERATURE | |
| 2700K : | 0.79 |
| 3000K : | 1.00 |
| 3500K : | 1.02 |
| 4000K : | 1.03 |
| CRI | |
| 90 CRI : | 1.00 |
| 97 CRI : | 0.90 |

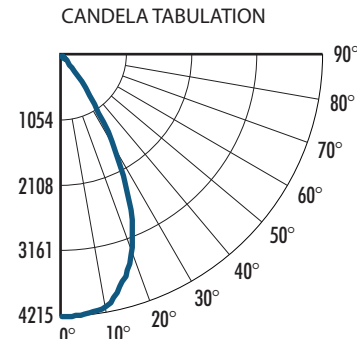

| FOOTCANDLE DISTRIBUTION | | |
|-------------------------|---------------|-------|
| Height | Beam Diameter | FC |
| 10.0' | 10.04' | 32.84 |
| 20.0' | 20.07' | 8.21 |
| 30.0' | 30.11' | 3.65 |
| 35.0' | 35.13' | 2.68 |
| 40.0' | 40.15' | 2.05 |

2025.06.02

PHOTOMETRY - WALL WASH (Data also applies for LRLD2673)

LRXLD2673W-L24-T30UE-D10 (2400lm, 30W, Wall Wash, 3000K)

System Power: 30.3W
 Test Date: 03/2025
 Color Temperature: 3000K
 CRI: 90
 Lumens Delivered: 3847.1
 CBCP: 2619.4
 Power Factor: >0.90

| MULTIPLIERS | |
|-----------------------|-------------|
| LUMEN OUTPUT | |
| 1000lm (-L09): | 0.38 |
| 1400lm (-L14): | 0.58 |
| 2400lm (-L24): | 1.00 |
| COLOR TEMPERATURE | |
| 2700K: | 0.79 |
| 3000K: | 1.00 |
| 3500K: | 1.02 |
| 4000K: | 1.03 |
| CRI | |
| 90 CRI: | 1.00 |
| 97 CRI: | 0.90 |

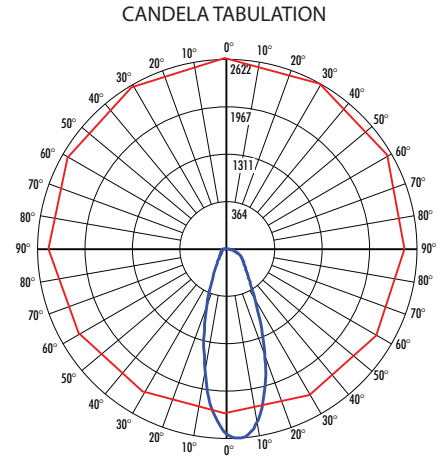

PERFORMANCE DATA

LUMINAIRE SPACED 3.5' FROM WALL

Footcandles On Wall

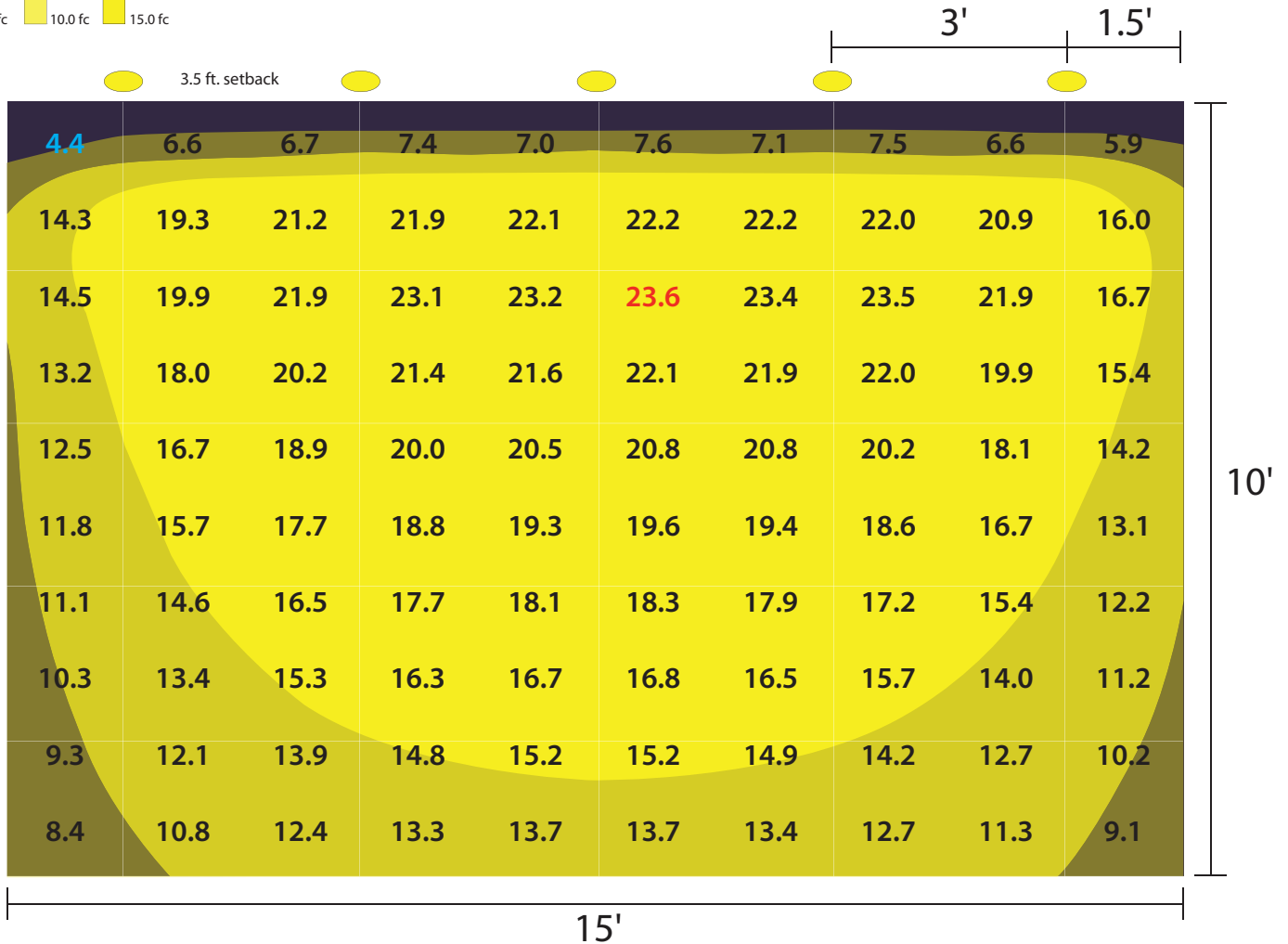

2025.06.02