

# ColorFlood - Wall Grazing SS2-RGBW-8R-15

15-LED Adjustable RGBW Round  
Flood/Spot DMX Light

CAT. NO.: \_\_\_\_\_  
TYPE: \_\_\_\_\_  
PROJECT: \_\_\_\_\_



## APPLICATION





For use as linear, direct flood and/or accent lighting, installed as an above grade fixture. Perfect for applications desiring a dynamic color changing effect. Recommended for retail, modern residential, hospitality and entertainment installations. RGBW design allows fine-tuned pastel colors and saturated hues without sacrificing illumination brightness. DMX control option allows the use of DMX512 Control Systems to individually control and change colors, set looks, and add lighting effects which can affect moods, feelings and atmosphere.

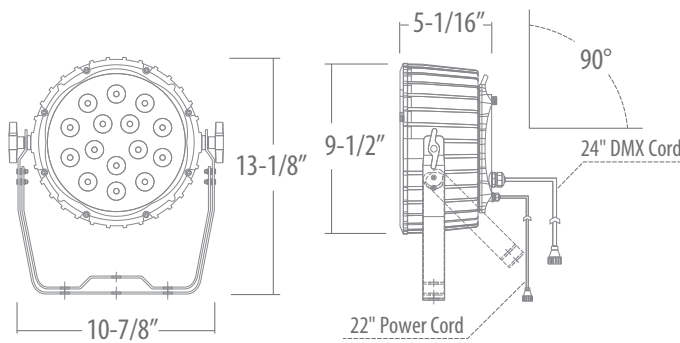



- 80W (15-LED) 4,425Max. Lumen
- DMX direct via LCD display, Proprietary quick connectors included
- IP65
- 25° beam spread
- LED Die Colors: RGBW
- Using proprietary technology, colors are efficiently blended together through an internal mixing chamber. The one-color output reduces unsightly views of isolated rainbow like striations.
- Smooth and flicker-free dimming of all colors down to 1%
- 5-Year Warranty

## DIMENSIONS



## ACCESSORIES

Glare Shield Visor To direct the light & reduce glare; if ordered, the VSR will arrive installed on fixture.	C-P-SS2-8R-15-VSR 
60" Plug-In Cord (in addition to cord included with unit) For connecting mains power to unit. Terminated in a 15A male Edison connector.	C-SWR-PWR-WL-60-PI 
80" Power Jumper For daisy chaining power from powered unit to unpowered unit. No more than 9 units max from mains power feed.	C-SWR-PWR-WL-80 
300" (25') Data Cable Interconnect For daisy chaining DMX from one fixture to another. Maximum 32 fixtures may be connected on any DMX run (for bare-end at one end, please specify -HW).	C-SWR-DMX-WL-300 

80" DMX/Data Jumper For daisy chaining DMX from one fixture to another. Maximum 32 fixtures may be connected on any DMX run (for bare-end at one end, please specify -HW).	C-SWR-DMX-WL-80 
Wet Location Power End Caps (in addition to the set included with unit) Protective cover for use in wet location environments for capping power connector cable.	C-PCL008-WL-PWR 
Wet Location DMX End Caps (in addition to the set included with unit) Protective cover for use in wet location environments to cap DMX cables. Not a DMX terminator.	C-PCL008-WL-DMX 
120 ohm DMX Terminator (4-pin)	C-PCL002-WL-DMX 

# ColorFlood - Wall Grazing SS2-RGBW-8R-15

15-LED Adjustable RGBW Round  
Flood/Spot DMX Light



## SPECIFICATIONS

### OUTPUT

Beam Angle: 25°

Lumens: 4,425 Max. Lumen

Efficacy (lm/W): 55 lm/W

LED Channels: Red/Green/Blue/White

Color Mixing: Using proprietary technology, colors are efficiently blended together through an internal mixing chamber. The one-color output reduces unsightly views of isolated Red, Green and Blue Diodes for a seamless rainbow-free appearance.

### ELECTRICAL

Input Voltage: Direct 120V to 277V input comes standard. 50/60 Hz

Power Consumption: 80W

### CONTROL

Interface: DMX direct via LCD display

Control System: DirectDMX Color Control. Color controlled with USITT DMX512A Standard Protocol to work with Coloronix or 3rd Party DMX Systems. On board LCD display inside the Data Enabler allow selecting of DMX addresses between 1-512 in a given DMX universe. DMX Data fed to housing via proprietary 4-wire data cable. Data Input/Output ports allow daisy-chaining of DMX Signal.

LED Die Colors: Red (620-635nm), Green (520-535nm), Blue (450-465nm) and Neutral White (4000K)

Dimming: Smooth and flicker-free dimming of all colors down to 1%

Stand Alone Control: Pre-Programmed static and dynamic scenes, as well as specific colors, can be user activated by the integral Data Enabler's computer eliminating the need for an external data source. On board OLED display inside the Data Enabler allows selection of over 30 static and dynamic color sequences. Display encased behind temperproof UV protected glass to reduce deterioration after long exposure to outdoor environments.

### LUMEN MAINTENANCE

L70 Life: 75,000 Hours for ambient temperatures under 100°F.

### PHYSICAL

Dimensions (Height x Width x Length): 13-1/8" x 5-1/16" x 10-7/8"

Housing Material: Die-cast aluminum to protect light emitting diodes, other electronics and preserve optical alignment. Painted black to maximize color mixing and eliminate stray light leaks. Integral split yoke allows for 90° tilt.

Weight: 9.6 lbs. (4.38kg)

Lens: PMMA Impact Resistant

Mounting: Split yoke provided for pipe, truss or surface mounting. Pre-drilled mounting holes on yoke.

Temperature Range: -4°F - 122°F / -20°F - 50°F Ambient

### ENVIRONMENT

IP65

### CERTIFICATION

cETL Listed



### WARRANTY

5-Year Warranty

## PHOTOMETRY

### FOOTCANDLE CALCULATION: SS2-RGBW-8R-15

Height	FC	Ø @ 50% of beam	Ø @ 90% of beam
11'	100	18'	38'
12'	87	20'	40'
15'	56	25'	50'
18'	39	30'	60'
20'	32	35'	73'

