

# WD1340-USA: 4" ROUND

1-DIRECTION WALL MOUNT (IP65) 1000LM/1500LM (10W/15W)

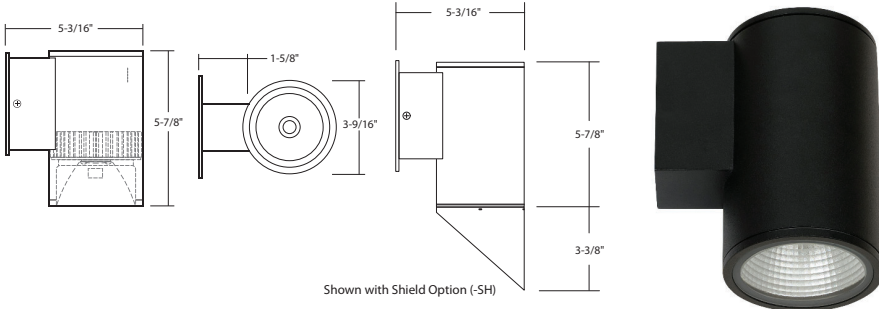

### • Produced in USA

- Uniform, low glare illumination
- Singular COB light source
- New integral emergency option
- 13' mtg. ht., 22' o.c. spacing (1000 lumen package)
- 25' mtg. ht., 22' o.c. spacing (1500 lumen package)
- 5-year limited warranty
- UniSense available
- Available with Type IV/Forward Throw Optics
- IK08 Rated
- New Die-Cast Mounting Plate (-WPDC4)

## ORDERING : WD1340-USAB-L15-CB35UE-D10-EMAC-T30

### WD1340-USA

Fixture	Finish	Lumen	Optics	Control	Emergency Options	LED	Options
<b>Finish</b>		<b>Optics</b>		<b>Control<sup>3</sup></b>		<b>LED</b>	
White (RAL 9003) <b>W</b>		<i>Standard Beams</i>		Non-Dimming (120V)	<b>Blank</b>	2700K (90 CRI)	<b>-T27</b>
Silver (RAL 7037) <b>S</b>		Wide Flood	<b>Blank</b>	0-10V Dimming (120V/277V)	<b>UE-D10</b>	3000K (90 CRI)	<b>-T30</b>
Bronze (RAL 8019) <b>BZ</b>		Narrow Spot	<b>-B10</b>	<b>Emergency Options</b>		3500K (90 CRI)	<b>-T35</b>
Black (RAL 9005) <b>B</b>		Spot	<b>-B20</b>			4000K (90 CRI)	<b>-T40</b>
Light Silver (RAL 7036) <b>LS<sup>1</sup></b>		Flood	<b>-B45</b>	None	<b>Blank</b>	5000K (80 CRI)	<b>-T50</b>
Dark Grey (RAL 7015) <b>DG<sup>1</sup></b>		<i>CleanBeam™ Option</i>		Remote Emergency	<b>-EMAC</b>	<b>Options</b>	
Metallic Gold (RAL 1001) <b>MG<sup>1</sup></b>		10° Pencil Beam	<b>-CB10</b>	BackPack (Side Mount)	<b>-EMB-SD<sup>6</sup></b>	None	<b>Blank</b>
Metallic Black (RAL 7021) <b>MB<sup>1</sup></b>		20° Clean Beam	<b>-CB20</b>	BackPack (Face Mount)	<b>-EMB-FC<sup>6</sup></b>	Hex-Cell Louver	<b>-LVR<sup>8</sup></b>
<b>Lumen</b>		35° Clean Beam	<b>-CB35</b>	BackPack (Empty, Side Mount)	<b>-EMB-BLANK-SD<sup>5</sup></b>	Photocell Sensor	<b>-SDL</b>
1000lm (10W)	<b>Blank</b>	<i>Specialty Beams</i>		BackPack (Empty, Face Mount)	<b>-EMB-BLANK-FC<sup>5</sup></b>	Surge Protector	<b>-SRG</b>
1500lm (15W)	<b>-L15</b>	Wall Wash	<b>-BWW</b>			Cold Weather	<b>-CW<sup>4,6</sup></b>
		Forward Throw (Type IV)	<b>-BIV</b>			Glare Shield	<b>-SH</b>
		Type II (30° x 60°)	<b>-BII<sup>2</sup></b>			Marine Grade Finish	<b>-MGD<sup>1</sup></b>
						Die-Cast Oversized Mounting Plate	<b>-WPDC4</b>

<sup>1</sup>Special Order Finish. Minimum order quantity (MOQ) applies. Orders less than MOQ are subject to a special paint set-up fee for the quantity ordered. Extended lead times may apply. Consult Factory.

<sup>2</sup>Special Order. Minimum order quantity (MOQ), extended lead time may apply. Consult Factory.

<sup>3</sup>Standard driver minimum starting temperature is -10°C / 14°F.

<sup>4</sup>Cold Weather Start (-CW) Starting Temperature -30°C / -22°F.

<sup>5</sup>Blank EM enclosure available for non-EM units to provide a seamless design aesthetic when EM enabled products are installed.

<sup>6</sup>(-EMB-SD) and (-EMB-FC) are not compatible with (-CW) option.

<sup>8</sup>(-LVR) Hex-Cell Louver is not compatible with CleanBeam Options (-CB10), (-CB20), (-CB35).

347 Input with 0-10V available. Consult Factory for details and lead time.

Energy Efficient Chip-On-Board (COB) Singular LED Light source provides for smooth uniform light output, eliminating the multiple shadow effect seen by multiple LED source products.

Binned with 3-Step MacAdam Ellipses as recommended by Ansi Standard. Available in 2700K, 3000K, 3500K, 4000K, and 5000K.

Custom RAL Color: Please note that we appreciate custom finishes. Custom finishes are subject to a special paint setup fee for the quantity ordered. Extended lead times may apply. Consult Factory.

## SPECIFICATION

### Application

This WD1 series single direction wall mount luminaire can be used for both interior and outdoor locations. The single reflector design can be used for direct illumination downward or indirect illumination upward for new construction or retrofit installations. Typical locations are in residential, commercial, and architectural facades and retail spaces that contain walls and/or columns.

### Housing/Arm

Housing is constructed from a round one piece high grade aluminum extrusion with a rectangular extrusion arm. Extrusions are 6061 alloy; <04% Cu. Faceplate (with a tempered, flush mounted, glass lens) and end caps are of a robust die cast aluminum alloy. The lens seals with a silicone O-ring and the Faceplate threads into Housing. An aluminum alloy mounting plate with a U-bracket installs onto an electrical junction box and secures into the arm with two (2) flat head countersunk phillips head stainless steel screws.

### Mounting:

The standard mounting plate is a square 4-1/4" plate with a U-Bracket that installs directly onto 3-1/2" or 4" octagonal electrical junction box. (-WPDC4) is a die-cast oversized 4-5/8" plate with a flat bracket designed to mount directly onto a 4" square junction box or a 3-1/2" or 4" octagonal electrical box.

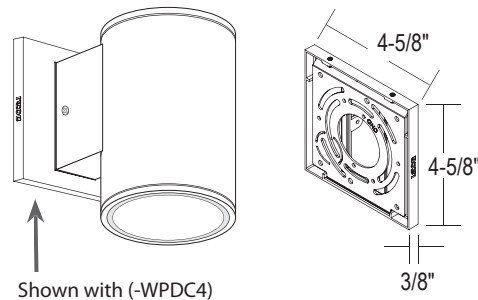

### Finish:

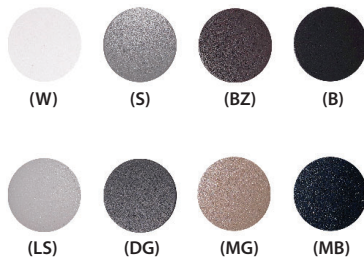

A 7- stage electrostatic, polymer process provides an outdoor textured powder coat finish that delivers outstanding durability, superior anti-aging, resistance to corrosion and UV-degradation. Consult factory for Custom Color. (More Information)

#### Standard Finishes:

White: RAL 9003 (W)  
 Silver: RAL 7037 (S)  
 Bronze: RAL 8019 (BZ)  
 Black: RAL 9005 (B)

#### Special Order Finishes:

Light Silver: RAL 7036 (LS)  
 Dark Gray: RAL 7015 (DG)  
 Metallic Gold: RAL 1001 (MG)  
 Metallic Black: RAL 7021 (MB)

## SPECIFICATION (Continued)

### Certifications and Listings:



ETL / cETL Listed to UL1598 and UL8750 standards.

Suitable wet locations. (IP65)

Assembled in USA.

IK08 rated for impact resistance.

### Caution:

LITON recommends use of surge protectors on the power entering LED Housings.  
Surge damage is not covered by warranty.

### Warranty

Covered by a 5-Year Warranty to be free of defects in materials and craftsmanship. Fixture should not be installed in applications with ambient temperature above 50°C/122°F. Doing so will result in reduced lamp life and voided warranty.

### Optics

Multifaceted aluminum reflector produces low glare illumination with multiple light control options.

### Standard Beam:

Used for maximum light output and visible field angle.

### CleanBeam™:

Used for a direct uniform light output with minimized field angle and to enhance building aesthetics.

### LED

COB (Chip on Board) singular LED light source provides for smooth, uniform light output, eliminating the imaging produced by multiple LED source optics.

### Lumen Maintenance:

Lumen Maintenance is minimum 50,000 hours L70 life based on ANSI TM-21 calculations from LM80 standardized test results.

### Lumen Options (Nominal):

1000lm (10W)  
1500lm (15W) (-L15)

### Color Temperature:

Binned with 4-step MacAdam ellipses as per ANSI Standard recommendation.

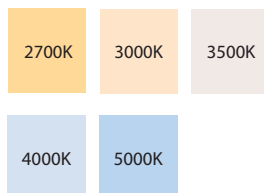

COLOR TEMP:	2700K	3000K	3500K	4000K	5000K
CRI:	90	90	90	90	80

## SPECIFICATION (Continued)

### Electrical

LED Driver: AC 50/60Hz Electronic Direct Current Class 2 driver integrally mounted.  
Power Factor > 0.90. See Dimming Section for voltage and wiring.

Minimum Operating Temperature:

Standard: -10°C/14°F

Cold Weather Option: (-CW) -30°C/-22°F

### Control Options

#### 0-10V Driver 120V/277V (UE-D10):

Compatible with most existing 0-10V systems. Also known as fluorescent or 5-Wire dimming. Allows smooth dimming down to 5% depending upon the dimmer's limitations. Compatible with daylight harvesting controls.

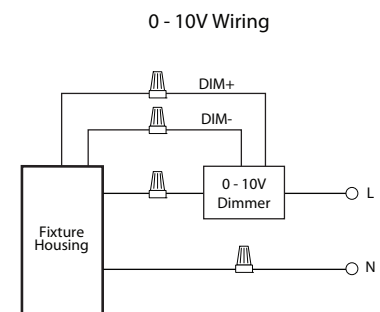

### Marine Grade

The fixture features a marine-grade textured powder coat finish engineered to withstand extreme environmental conditions, including prolonged exposure to UV radiation, salt air, and moisture, which are prevalent in coastal and high-humidity environments.

A multi-stage surface preparation, finishing, and curing process ensures maximum adhesion, durability, and corrosion resistance. The coating system undergoes rigorous salt spray (ASTM B117) testing, overbake resistance verification, and pencil hardness testing to validate its robustness against degradation.

The marine-grade powder coat is applied as a 30–50 µm bottom layer, providing a strong anti-corrosion foundation. This is further enhanced by a surface coat using a standard architectural-grade powder application with a total thickness of 80–120 µm, ensuring superior resistance to wear, impact, and environmental stressors.

## SPECIFICATION (Continued)

### REMOTE LOCATION EMERGENCY INVERTER (-EMAC): 25W and 40W

For installation away from the surface of the building in remote hidden location.

- Hidden Emergency Equipment
- Must be installed in Dry Locations
- Wattage package will determine if 25W or 40W battery gets sent; corresponding wiring diagrams below
- 170 VDC output to AC DRIVER during EM mode

**Not rated for outdoor mounting. Damp location rated.**

#### <25W LOAD

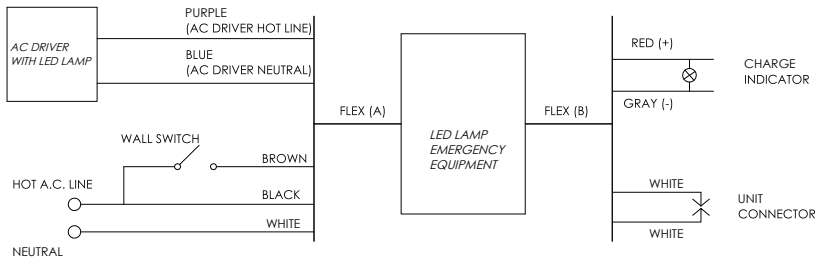

Input Voltage:	120-277VAC/60Hz
Output Voltage:	170VDC (120VAC Equivalent)
Wattage:	25W
Switching Time:	<1s
Charging Time:	24h
Operating Time:	90 minutes
Minimum Temperature:	0°C
Maximum Temperature:	50°C
Maximum Lumens:	2200lm
Self-Diagnostic:	No

#### <40W LOAD

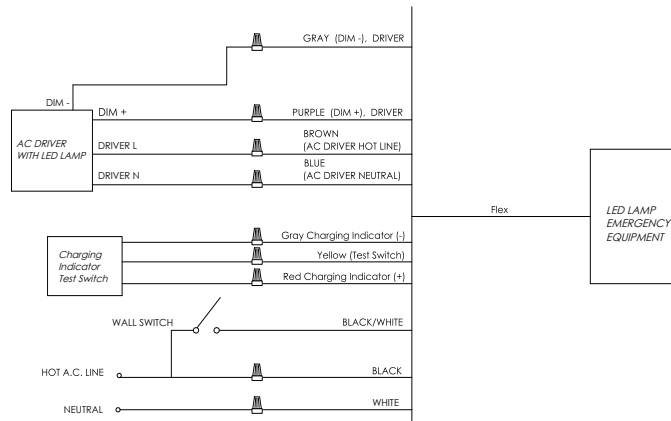

Input Voltage:	120-277VAC/60Hz
Output Voltage:	170VDC (120VAC Equivalent)
Wattage:	40W
Switching Time:	<1s
Charging Time:	24h
Operating Time:	90 minutes
Minimum Temperature:	0°C
Maximum Temperature:	50°C
Maximum Lumens:	3500lm
Self-Diagnostic:	Yes

#### >40W LOAD

- 0-10V dimmable driver required

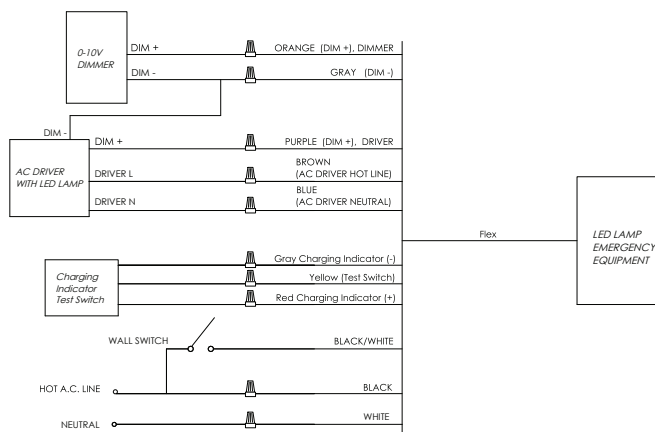

## SPECIFICATION (Continued)

### BackPack Side Mount (-EMB-SD/FC):

Eliminates need for long runs back to remote emergency battery location. Installs directly on building surface. Ideal for locations wanting same mounting aesthetics for Emergency and Non-Emergency fixtures without the use of remote Emergency power. Can be fed from recessed wall mounted junction box from the back of fixture or surface conduit from side of fixture.

- Wet location rated.
- 120V-347V operation.
- Self diagnostic.
- Integral surge protector for emergency driver only.
- Includes (2) 1/2" NPT knock-outs.
- Optional -EMB-BLANK can be used to maintain a common aesthetic when -EMB-FC are used.

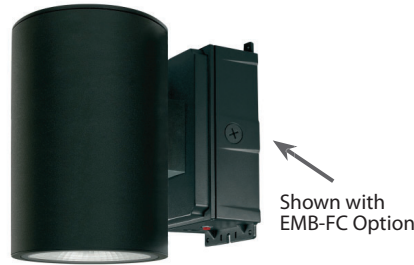

Shown with EMB-FC Option

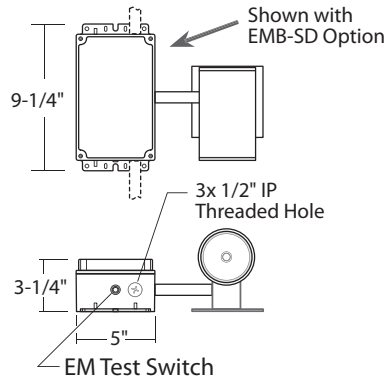

Output Power:	18 Watts (Max)
Input Power:	7 Watts (Max)
Emergency Operation:	≥90 minutes
Operating temp:	0°C/32°F to 50°C/122°F
Input Voltage:	120V-347 VAC
Battery:	Recyclable lithium battery 24 Hour Recharge 7-10 Year Life Expectancy
Charge Time:	24 hours
Max Distance:	25'
Weight:	3-3/4 lbs.
Warranty:	5-year
Surge Protection:	Integral 3,000V
Self-diagnostic testing:	Monthly 30 sec. test, Yearly 90 min. test to verify proper emergency operation per life safety code requirements.

### (<18W)

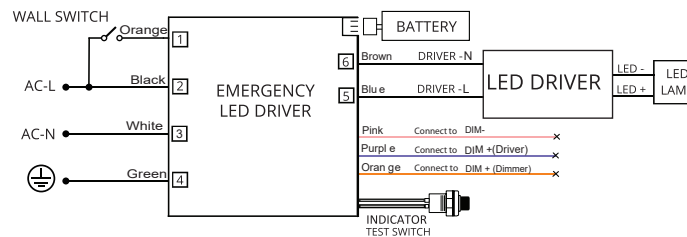

### (18W-200W)

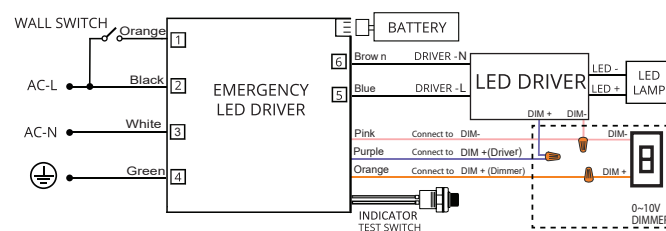

## SPECIFICATION (Continued)

### Additional Options

---

Hexcell Louver (-LVR):

3 mm /.125" (size of the cells) - matte black finish, 45° glare cutoff, unframed.



Photocell (/SDL):

Sensor enables automatic on/off operation based on ambient light levels, providing dusk-to-dawn functionality.

Power Consumption .5W

Voltage: 120V, 277V

On/Off Levels: On @ 0-2fc / Off @ 2fc or more

Warranty: 2-Year / 5,000 Cycles

Sensor Size: 3/8"

Rating: UL/cUL



Surge Suppressor (/SRG):

Protects driver against surges in line voltage/current (20KV, 1.2/50µS & 10KA, 8/20µS).

Provides a positive indication of end-of-life by opening voltage to the load.

Surge suppressor is a perishable device requiring periodic replacement.

Not a warrantied item.

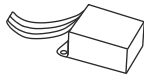

## WD1340 (L15) PHOTOMETRY

### Footcandles On Wall

■ .5 fc ■ 1.0 fc ■ 2.0 fc ■ 5.0 fc

**STANDARD BEAM – Wide Flood (Blank)**  
3 ft Grid

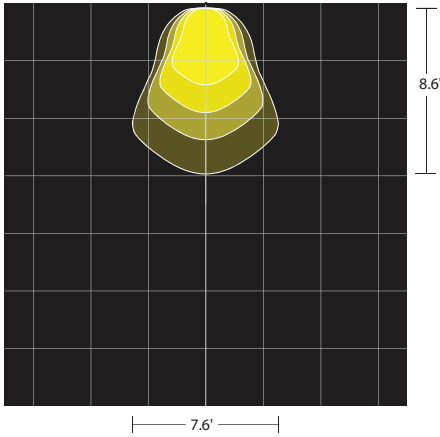

**CLEANBEAM™ – (-B02)**  
3 ft Grid

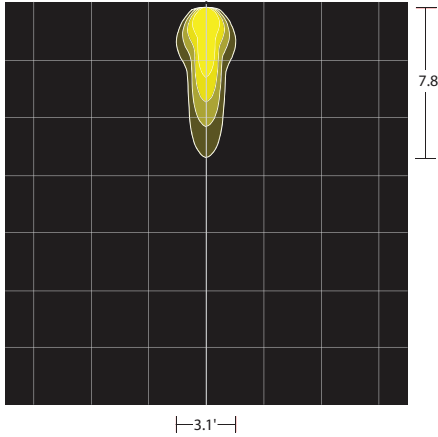

**CLEANBEAM™ – (-CB20)**  
3 ft Grid

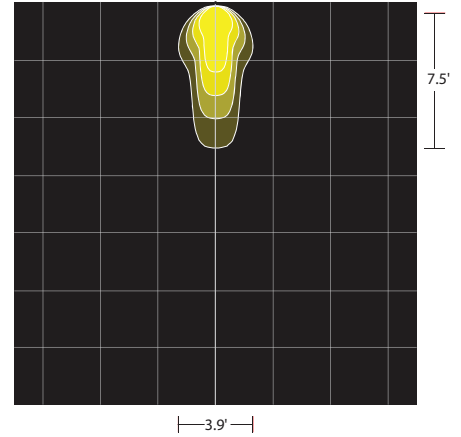

**CLEANBEAM™ – (-CB35)**  
3 ft Grid

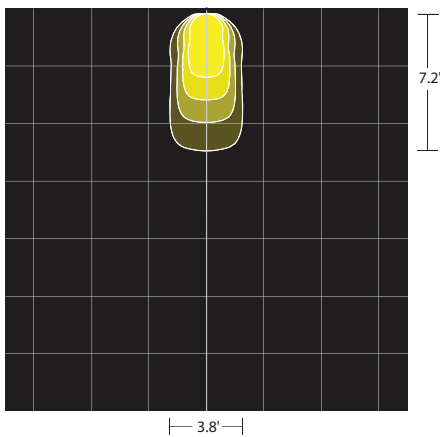

**SPECIALTY BEAM – Wall Wash (-BWW)**  
3 ft Grid

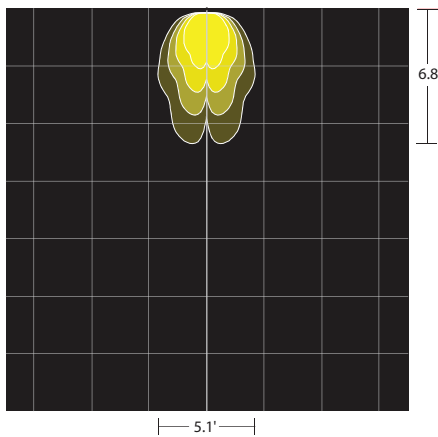

### FOOTCANDLES ON WALL AND GROUND

■ .5 fc ■ 1.0 fc ■ 2.0 fc ■ 5.0 fc

**STANDARD BEAM – Wide Flood (Blank)**  
3 ft Grid

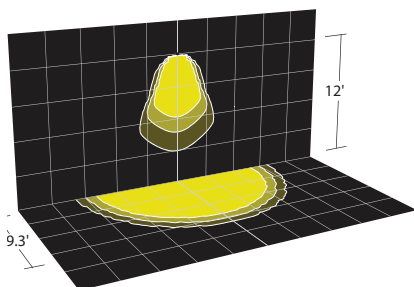

**SPECIALTY BEAM – Type II (-BII)**  
3 ft Grid

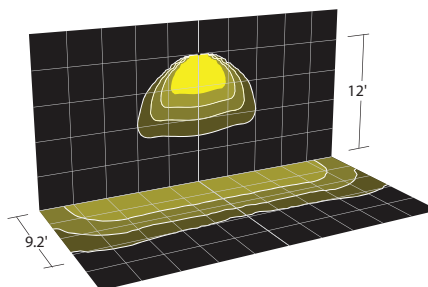

**SPECIALTY BEAM – Type IV (-BIV)**  
3 ft Grid

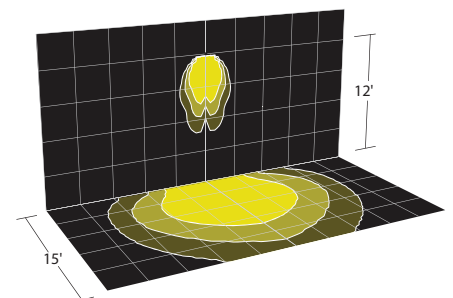

2023.07.17

## PHOTOMETRY – WD1340 (L15) (Cont.)

### Footcandles On Ground (2 - Fixture Overlap)

■ .5 fc ■ 1.0 fc ■ 2.0 fc ■ 5.0 fc

**STANDARD BEAM – WIDE FLOOD 8 ft Mtg Ht**

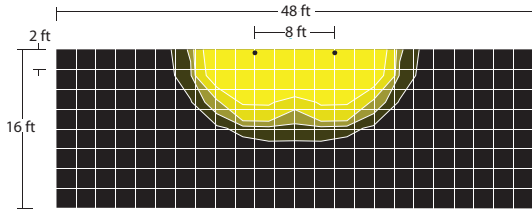

**STANDARD BEAM – WIDE FLOOD 16 ft Mtg Ht**

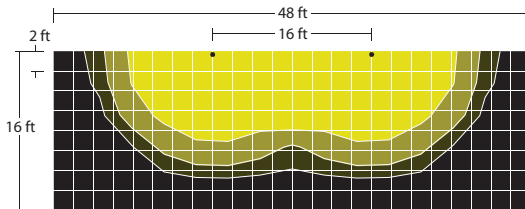

**SPECIALTY BEAM – TYPE IV (-BIV) 8 ft Mtg Ht**

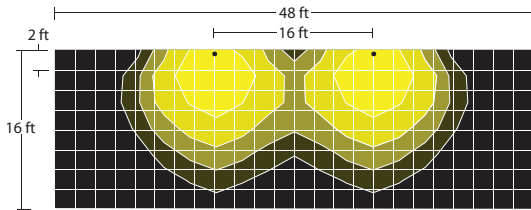

**SPECIALTY BEAM – TYPE IV (-BIV) 16 ft Mtg Ht**

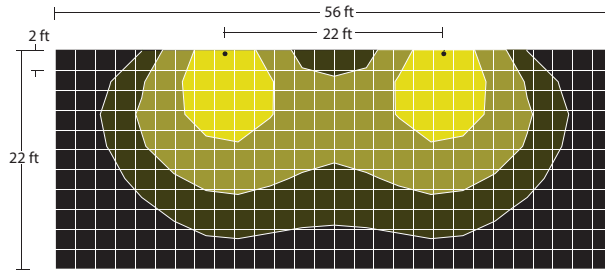

**SPECIALTY BEAM – TYPE II (-BII) 8 ft Mtg Ht**

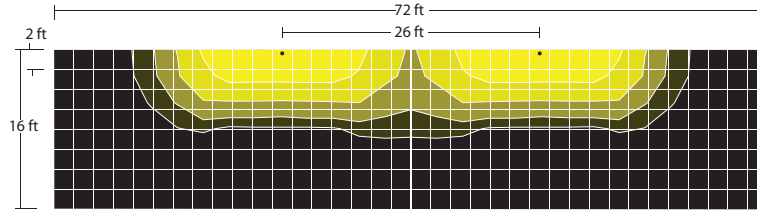

**SPECIALTY BEAM – TYPE II (-BII) 16 ft Mtg Ht**

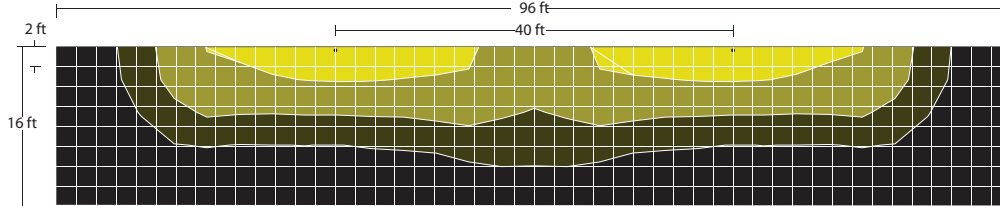

## LUMEN OUTPUT / LPW /BUG RATING

LM	W	Beam Spread	-T27 (2700K, 90 CRI)					-T30 (3000K, 90 CRI)					-T35 (3500K, 90 CRI)					Blank (4000K, 90 CRI)					-T50 (5000K, 80 CRI)									
			LM	LPW	cd	B	U	G	LM	L/W	cd	B	U	G	LM	LPW	cd	B	U	G	LM	LPW	cd	B	U	G	LM	LPW	cd	B	U	G
1000 lm	13.9	Wide FL	594	43	788	1	0	0	841	60	821	1	0	0	852	61	832	1	0	0	854	61	834	1	0	0	1018	73	994	1	0	0
		-B02	175	13	569	0	0	0	250	18	593	0	0	0	254	18	601	0	0	0	254	18	602	0	0	0	303	22	717	0	0	0
		-CB20	284	20	660	1	0	0	406	29	687	1	0	0	411	30	697	1	0	0	412	30	698	1	0	0	491	35	832	1	0	0
		-CB35	360	26	598	1	0	0	513	37	622	1	0	0	520	37	631	1	0	0	521	37	632	1	0	0	621	45	753	1	0	0
		-B10	750	54	11642	1	0	0	1070	77	12120	1	0	0	1085	78	12290	1	0	0	1087	78	12313	1	0	0	1295	93	14674	1	0	0
		-B20	682	49	4355	1	0	0	1043	75	4534	1	0	0	1058	76	4597	1	0	0	1060	76	4606	1	0	0	1263	91	5489	1	0	0
		-B45	755	54	1913	1	0	0	1026	74	1991	1	0	0	1040	75	2019	1	0	0	1042	75	2023	1	0	0	1242	89	2411	1	0	0
		-BII	694	50	754	2	0	0	989	71	784	2	0	0	1003	72	795	2	0	0	1005	72	797	2	0	0	1198	86	950	2	0	0
		-BWW	596	43	703	1	0	0	850	61	732	1	0	0	862	62	743	1	0	0	864	62	744	1	0	0	1030	74	887	1	0	0
-BIV	596	43	703	1	0	0	850	61	732	1	0	0	862	62	743	1	0	0	864	62	744	1	0	0	1030	74	887	1	0	0		
-L15 (1500 lm)	20.6	Wide FL	1440	70	1057	1	0	0	1499	73	1100	1	0	0	1520	74	1116	1	0	0	1523	74	1118	1	0	0	1815	88	1332	1	0	0
		-B02	429	21	780	1	1	0	447	22	812	1	1	0	453	22	823	1	1	0	454	22	825	1	1	0	541	26	983	1	1	0
		-CB20	691	34	902	1	0	0	719	35	939	1	0	0	729	35	952	1	0	0	731	35	954	1	0	0	871	42	1137	1	0	0
		-CB35	874	42	814	1	0	0	910	44	847	1	0	0	923	45	859	1	0	0	924	45	861	1	0	0	1102	53	1026	1	0	0
		-B10	1808	88	15548	1	0	0	1882	91	16187	1	0	0	1909	93	16414	1	0	0	1912	93	16445	1	0	0	2279	111	19598	1	0	0
		-B20	1757	85	5768	2	0	0	1830	89	6005	2	0	0	1855	90	6089	2	0	0	1859	90	6101	2	0	0	2215	108	7271	2	0	0
		-B45	1313	64	2549	2	0	0	1367	66	2654	2	0	0	1386	67	2691	2	0	0	1389	67	2696	2	0	0	1655	80	3213	2	0	0
		-BII	1686	82	1029	2	0	0	1756	85	1071	2	0	0	1780	86	1086	2	0	0	1784	87	1088	2	0	0	2126	103	1297	2	0	0
		-BWW	1131	55	748	1	0	0	1177	57	779	1	0	0	1194	58	789	1	0	0	1196	58	791	1	0	0	1423	69	941	1	0	0
-BIV	1131	55	748	1	0	0	1177	57	779	1	0	0	1194	58	789	1	0	0	1196	58	791	1	0	0	1425	69	943	1	0	0		