

| WD1340 : 4" ROUND 1-DIRECTION

WALL MOUNT (IP65) AMBER (TURTLE SAFE) 200LM (12W)

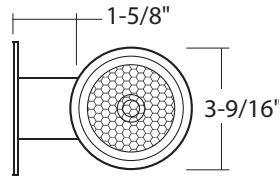

WD1340_TAM-LVR
Shown with Shield Option (-SH)

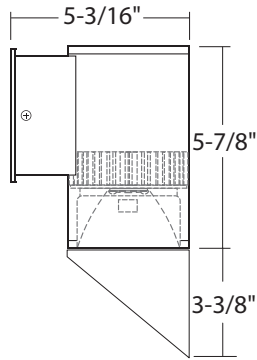
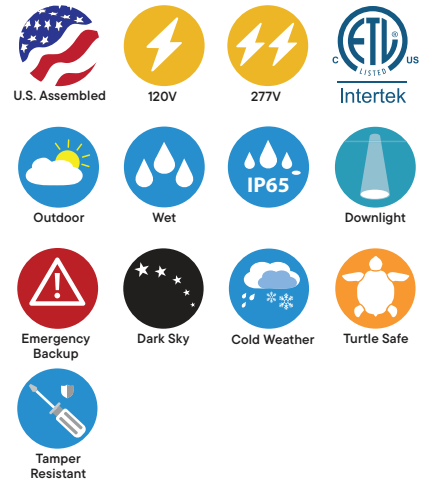

- True Amber Narrow Wavelength 590nm LED
- Integral Surface J-Box Option
- Emergency back up available
- 5-Year Limited Warranty
- IK08 Rated
- New Die-Cast Mounting Plate (-WPDC4)

ORDERING : WD1340WUE-D10-TAM-LVR-EMAC

Finish	Control	LED	Emergency Options	Options
White	WD1340W	Non-Dimming (120V)	Blank	590nm Amber
Silver	WD1340S	UniDim™ 0-10V, TRIAC/ELV Dimming (120V/277V)	UE-DUN	-TAM-LVR
Bronze	WD1340BZ	Casambi Wireless Dimming (120V/277V)	-DCSM¹	Emergency Options
Black	WD1340B	BubblyNet Wireless System (120V/277V)	-DBNT¹	None
Light Silver	WD1340LS²	SimplySnap Wireless System (120V/277V)	-DSYN^{1,4}	Blank
Dark Grey	WD1340DG²			Remote Emergency
Metallic Gold	WD1340MG²			BackPack (Side Mount)
Metallic Black	WD1340MB²			BackPack (Face Mount)
				BackPack (Empty, Side Mount)
				BackPack (Empty, Face Mount)
				-EMAC
				-EMB-SD⁶
				-EMB-FC⁶
				-EMB-BLANK-SD⁵
				-EMB-BLANK-FC⁵
				None
				Cold Weather
				Surge Protector
				Daylight Sensor (120V)
				Glare Shield
				Marine Grade Finish
				Die-Cast Oversized Mounting Plate
				Blank
				-CW³
				-SRG
				-SDL
				-SH
				-MGD²
				-WPDC4

¹Special Order. Special order. Minimum Order, Extended lead time may apply. Consult Factory.
²Special Order Finish. Minimum order quantity (MOQ) applies. Orders less than MOQ are subject to a special paint set-up fee for the quantity ordered. Extended lead times may apply. Consult Factory.
³Starting Temperature -40°C/-40°F. Only available with (UE-DUN) control option.
⁴Special Order. Must be ordered with -EMB-BLANK.

SPECIFICATION

Application

This WD1 series single direction wall mount luminaire can be used for both interior and outdoor locations. The single reflector design can be used for direct illumination downward or indirect illumination upward for new construction or retrofit installations. Typical locations are in residential, commercial, and architectural facades and retail spaces that contain walls and/or columns.

Housing/Arm

Housing is constructed from a round one piece high grade aluminum extrusion with a rectangular extrusion arm. Extrusions are 6061 alloy; <04% Cu. Faceplate (with a tempered glass lens) and end caps are die-cast aluminum (Alloy A360; <.6% Cu) and seal the housing (top and bottom) using silicone o-rings. An aluminum alloy mounting plate with a U-bracket installs onto an electrical junction box and secures into the arm with two (2) flat head countersunk phillips head stainless steel screws.

Mounting:

The standard mounting plate is a square 4-1/4" plate with a U-Bracket that installs directly onto 3-1/2" or 4" octagonal electrical junction box. (-WPDC4) is a die-cast oversized 4-5/8" plate with a flat bracket designed to mount directly onto a 4" square junction box or a 3-1/2" or 4" octagonal electrical box.

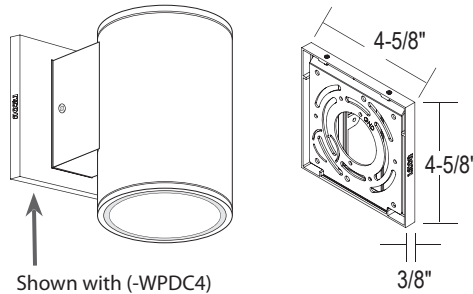

Finish:

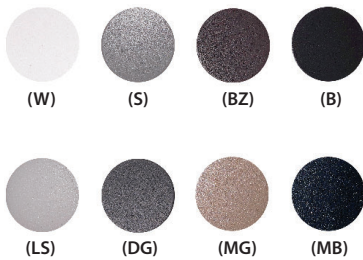

A 7- stage electrostatic, polymer process provides an outdoor textured powder coat finish that delivers outstanding durability, superior anti-aging, resistance to corrosion and UV-degradation. Consult factory for Custom Color. (More Information)

Standard Finishes:

White: RAL 9003 (W)
 Silver: RAL 7037 (S)
 Bronze: RAL 8019 (BZ)
 Black: RAL 9005 (B)

Special Order Finishes:

Light Silver: RAL 7036 (LS)
 Dark Gray: RAL 7015 (DG)
 Metallic Gold: RAL 1001 (MG)
 Metallic Black: RAL 7021 (MB)

SPECIFICATION (Continued)

LED

LED light source provides for smooth, uniform light output, eliminating the imaging produced by multiple LED source optics.

Lumen Maintenance: Lumen Maintenance is minimum 50,000 hours L70 life based on ANSI TM-21 calculations from LM80 standardized test results.

Lumen Options (Nominal): 250lm (22W)

Color Temperature: Binned with 4-step MacAdam ellipses as per ANSI Standard recommendation.

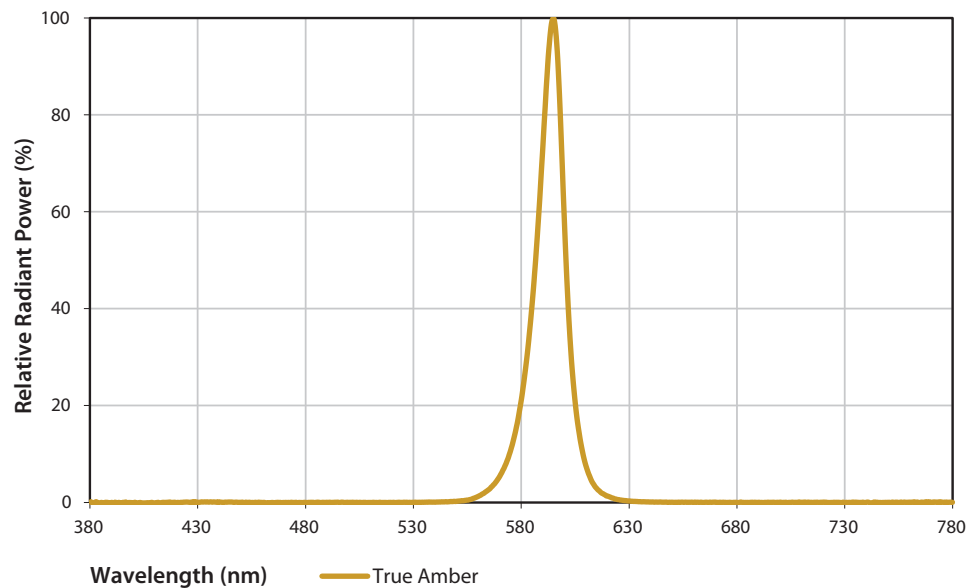

True Amber - Narrow Band LEDs centered at 590nm with no spectral content below 560nm are supplied.

Marine Grade: The fixture features a marine-grade textured powder coat finish engineered to withstand extreme environmental conditions, including prolonged exposure to UV radiation, salt air, and moisture, which are prevalent in coastal and high-humidity environments.

A multi-stage surface preparation, finishing, and curing process ensures maximum adhesion, durability, and corrosion resistance. The coating system undergoes rigorous salt spray (ASTM B117) testing, overbake resistance verification, and pencil hardness testing to validate its robustness against degradation.

The marine-grade powder coat is applied as a 30–50 µm bottom layer, providing a strong anti-corrosion foundation. This is further enhanced by a surface coat using a standard architectural-grade powder application with a total thickness of 80–120 µm, ensuring superior resistance to wear, impact, and environmental stressors.

SPECIFICATION (Continued)

Control Options

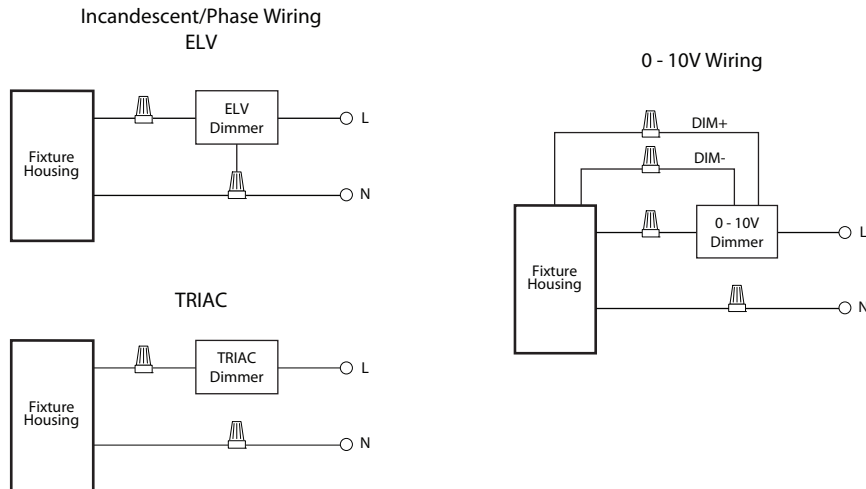

Electrical

LED Driver: AC 50/60Hz Electronic Direct Current Class 2 driver integrally mounted.
Power Factor > 0.90. See Dimming Section for voltage and wiring.

Minimum Operating Temperature:
Standard: -10°C/14°F
Cold Weather Option: (-CW) -40°C/-40°F

Warranty

Covered by a 5-Year Warranty to be free of defects in materials and craftsmanship. Fixture should not be installed in applications with ambient temperature above 50°C/122°F. Doing so will result in reduced lamp life and voided warranty.

Emergency Options

Emergency LED Battery Back-up available, remotely mounted adjacently by the installer. When AC power fails, the device immediately switches to the emergency mode, operating the LEDs for a minimum of 90 minutes. Remote test switch and plate cover included. Optional Generator Transfer Device switches the driver to auxiliary generator power during the loss of normal AC power, (recommended for applications requiring individual circuit switching).

SPECIFICATION (Continued)

FULL POWER EMERGENCY INVERTER (-EMAC): 15W Emergency Battery

- Must be installed in Dry Locations
- Wattage package will determine battery sent; corresponding wiring diagrams below
- 170 VDC output to AC DRIVER during EM mode

Not rated for outdoor mounting. Damp location rated.

-EMAC Lumen Data (Battery)

Fixture/Trim	WD1340*-TAM-LVR
Fixture Wattage:	14W
Fixture Lumens:	250
EM Lumens:	250

<18W LOAD

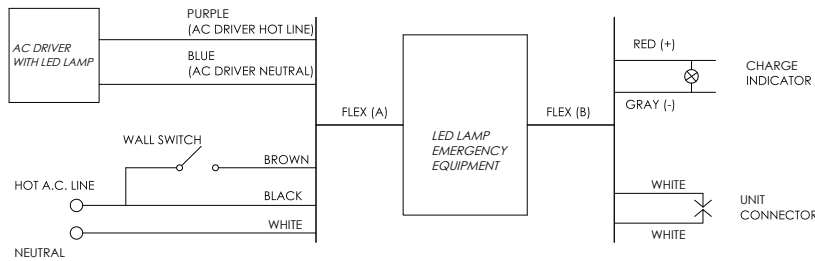

Input Voltage:	120-277VAC/60Hz
Output Voltage:	170VDC (120VAC Equivalent)
Wattage:	25W
Switching Time:	<1s
Charging Time:	24h
Operating Time:	90 minutes
Minimum Temperature:	0°C
Maximum Temperature:	50°C
Self-Diagnostic:	No

SPECIFICATION (Continued)

Emergency Battery, BackPack Side Mount (-EMB-FC or -EMB-SD):

Eliminates need for long runs back to remote emergency battery location. Installs directly on building surface. Ideal for locations wanting same mounting aesthetics for Emergency and Non-Emergency fixtures without the use of remote Emergency power. Can be fed from recessed wall mounted junction box from the back of fixture or surface conduit from side of fixture.

- Wet location rated.
- 120V-347V operation.
- Self diagnostic.
- Integral surge protector for emergency driver only.
- Includes (2) 1/2" NPT knock-outs.
- Optional -EMB-BLANK can be used to maintain a common aesthetic when -EMB-FC are used.



Shown with EMB-FC Option

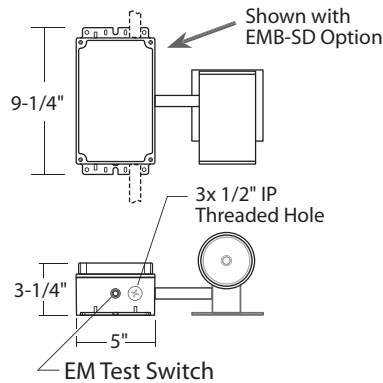

Output Power:	18 Watts (Max)
Input Power:	7 Watts (Max)
Emergency Operation:	≥90 minutes
Operating temp:	0°C/32°F to 50°C/122°F
Input Voltage:	120V-347 VAC
Battery:	Recyclable lithium battery 24 Hour Recharge 7-10 Year Life Expectancy
Charge Time:	24 hours
Max Distance:	25'
Weight:	3-3/4 lbs.
Warranty:	5-year
Surge Protection:	Integral 3,000V
Self-diagnostic testing:	Monthly 30 sec. test, Yearly 90 min. test to verify proper emergency operation per life safety code requirements.

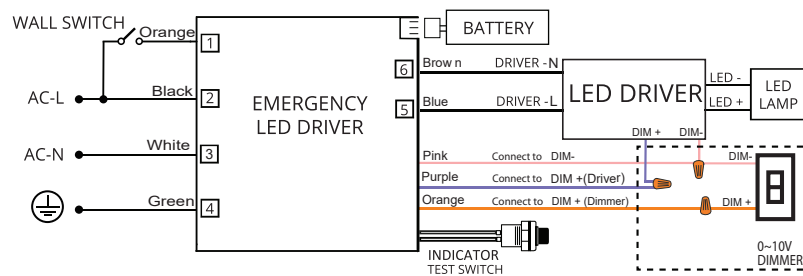

SPECIFICATION (Continued)

Additional Options

Hexcell Louver (-LVR):

3 mm / .125" (size of the cells) - matte black finish, 45° glare cutoff, unframed.



Photocell (/SDL):

Sensor enables automatic on/off operation based on ambient light levels, providing dusk-to-dawn functionality.

Power Consumption .5W

Voltage: 120V, 277V

On/Off Levels: On @ 0-2fc / Off @ 2fc or more

Warranty: 2-Year / 5,000 Cycles

Sensor Size: 3/8"

Rating: UL/cUL



Surge Suppressor (/SRG):

Protects driver against surges in line voltage/current (20KV, 1.2/50µS & 10KA, 8/20µS).

Provides a positive indication of end-of-life by opening voltage to the load.

Surge suppressor is a perishable device requiring periodic replacement.

Not a warrantied item.

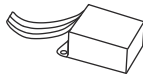

Certifications and Listings:

ETL / cETL Listed to UL1598 and UL8750 standards.

Suitable wet locations. (IP65).

Assembled in USA.

IK08 rated for impact resistance.



PHOTOMETRY

WD1340B-TAM-LVR (250lm, 14W)

System Power: 14W
 Test Date: 09/2025
 Beam Angle 50%: 46.9°
 Field Angle 10%: 77.1°
 Color Temperature: 1470K
 Lumens Delivered: 281
 CBCP: 420
 Power Factor: 0.99

CANDELA TABULATION

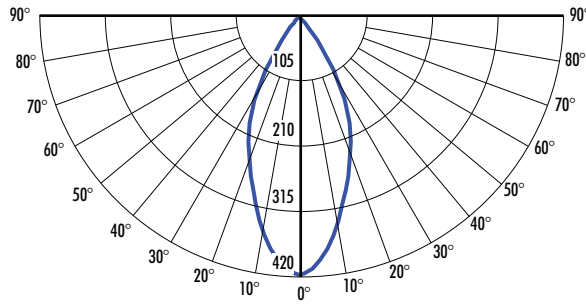

FOOTCANDLE DISTRIBUTION

Height	Beam Diameter	FC
6.0'	5.18'	11.67
8.0'	6.91'	6.56
10.0'	8.63'	4.20
12.0'	10.36'	2.92
14.0'	12.09'	1.42
16.0'	13.81'	1.64

2025.09.16