

WD1472 : 8" x 4" SCOOP

1-DIRECTIONAL WALL MOUNT (IP65) 850LM (15W)

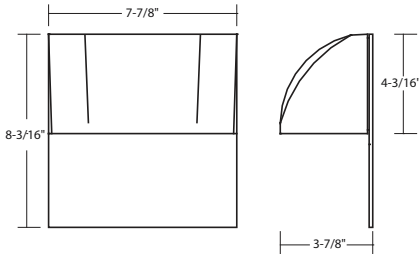

Shown with Signage Plate (-PL)



- Now with Integral Emergency Option!
- Sleek architectural design
- Durable, corrosion resistant finish
- Emergency back up available
- 5-year limited warranty

ORDERING : WD1472B-FRUE-D10-T30-BWW-EMB-FC

WD1472

Fixture	Finish	Lens	Dimming	LED	Optics	Emergency Options	Options
Finish		Dimming		LED		Emergency Options	
White	(RAL 9003) W		Non-Dimming (120V)	Blank	4000K (90 CRI)	Blank	None
Silver	(RAL 7037) S		ELV and Triac Dimming (120V)	-DIN	3000K (90 CRI)	-T30	Remote
Bronze	(RAL 8019) BZ		0-10V Dimming (120V/277V)	UE-D10	Optics		Back Pack (Side Mount)
Black	(RAL 9005) B		0-10V 1% Dimming (120V/277V)	UE-D10P1	None	Blank	Back Pack (Face Mount)
Light Silver	(RAL 7036) LS ²		UniDim™ (120V/277V)	UE-DUN	Forward Throw (Type IV)	-BIV	Back Pack (Empty)
Dark Grey	(RAL 7015) DG ²		347V 0-10V Dimming	-347-D10 ¹	Wall Wash	-BWW	
Metallic Gold	(RAL 1001) MG ²						
Metallic Black	(RAL 7021) MB ²						
Lens						Options	
Clear		Blank					None
Frosted		-FR					Photocell Sensor
							Color Changing
							Signage Plate

¹ Special order. Minimum order quantity, extended lead time, and setup fee may apply. Consult factory.
² Special Order Finish. Minimum order quantity (MOQ) applies. Orders less than MOQ are subject to a special paint set-up fee for the quantity ordered. Extended lead times may apply. Consult Factory.
³ Blank EM enclosure available for Non-EM units to provide a seamless design aesthetic when EM enabled products are installed.

Custom RAL Color: Please note that we appreciate custom finishes. Custom finishes are subject to a special paint setup fee for the quantity ordered. Extended lead times may apply. Consult Factory.

SPECIFICATION

Application

This WD1 series single direction wall mount luminaire can be used for both interior and outdoor locations. The single reflector design can be used for direct illumination downward or indirect illumination upward for new construction or retrofit installations. Typical locations are in residential, commercial, and architectural facades and retail spaces that contain walls and/or columns.

Housing/Arm

Housing and Arm are constructed of one piece rectilinear high grade aluminum extrusions (Alloy 6061 <.04% Cu). Faceplate (with flush mounted tempered glass lens) and end caps are of a robust die cast aluminum alloy sealing the housing (top and bottom) using silicone gaskets. An aluminum alloy mounting plate with a U-bracket installs onto an electrical junction box and secures into the arm with two (2) flat head countersunk phillips head stainless steel screws.

Mounting:

The 6" high x 4-1/2" wide rectangular mounting plate with U-bracket installs onto a 4" octagonal electrical junction box. For other junction box sizes see installation instructions.

Finish:

A 7-stage electrostatic, polymer process provides an outdoor textured powder coat finish that delivers outstanding durability, superior anti-aging, resistance to corrosion and UV-degradation. Consult factory for Custom Color. (More Information)

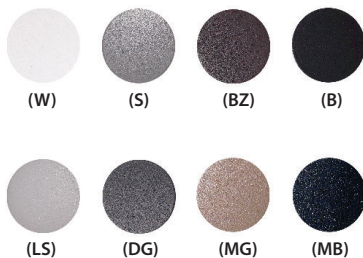

Standard Finishes:

White: RAL 9003 (W)
 Silver: RAL 7037 (S)
 Bronze: RAL 8019 (BZ)
 Black: RAL 9005 (B)

Special Order Finishes:

Light Silver: RAL 7036 (LS)
 Dark Gray: RAL 7015 (DG)
 Metallic Gold: RAL 1001 (MG)
 Metallic Black: RAL 7021 (MB)

Certifications and Listings:

ETL / cETL Listed to UL1598 and UL8750 standards.

Suitable wet locations. (IP65)

Assembled in USA.

IK08 rated for impact resistance.



SPECIFICATION (Continued)

Caution: LITON recommends use of surge protectors on the power entering LED Housings. Surge damage is not covered by warranty.

Warranty

Covered by a 5-Year Warranty to be free of defects in materials and craftsmanship. Fixture should not be installed in applications with ambient temperature above 50°C/122°F. Doing so will result in reduced lamp life and voided warranty.

Optics

Multifaceted aluminum reflector produces low glare illumination with Forward Throw (Type IV) optic.

LED

COB (Chip on Board) singular LED light source provides for smooth, uniform light output, eliminating the imaging produced by multiple LED source optics.

Lumen Maintenance: Lumen Maintenance is a minimum 50,000 hours L70 life based on ANSI TM-21 calculations from LM80 standardized test results.

Lumen Options (Nominal): 850 lm (15W)

Color Temperature: Binned with 4-step MacAdam ellipses as per ANSI Standard recommendation.

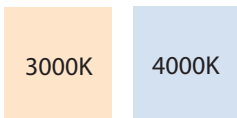

COLOR TEMP:	3000K	4000K
CRI:	90	90

SPECIFICATION (Continued)

Emergency Options

When AC power fails, provides 90 minutes of power to the luminaire. In the event of a power failure, the LED Emergency backup switches to the emergency mode and operates the existing fixture for 90 minutes. The unit contains a battery, charger, and converter circuit in a single enclosure.

Remote Emergency Back Up (-EMAC):

For installation away from the surface of the building in remote hidden location.

- Hidden Emergency Equipment
- Must be installed in Dry Locations

Not rated for outdoor mounting.
Damp location rated.

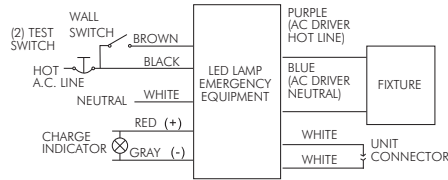
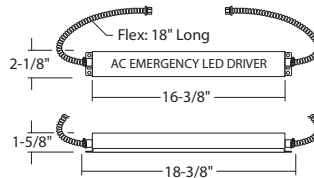

Output Power:	25 Watts (Max)
Input Power:	6 Watts (Max)
Emergency Operation:	≥90 minutes
Operating temp:	0°C/32°F to 50°C/122°F
Input Voltage:	100-277 VAC, 50-60Hz
Battery:	High Temp Nickel-Cadmium 48 Hour Recharge 7-10 Year Life Expectancy
Charge Time:	24 hours
Max Distance:	25'
Weight:	3 lbs.
Warranty:	2-year
Surge Protection:	None

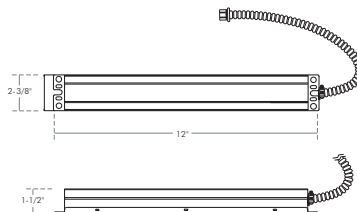

Input Voltage:	120-277VAC/60Hz
Output Voltage:	170VDC (120VAC Equivalent)
Wattage:	40W
Switching Time:	<1s
Charging Time:	24h
Operating Time:	90 minutes
Minimum Temperature:	0°C
Maximum Temperature:	50°C
Maximum Lumens:	3500lm

<40W LOAD

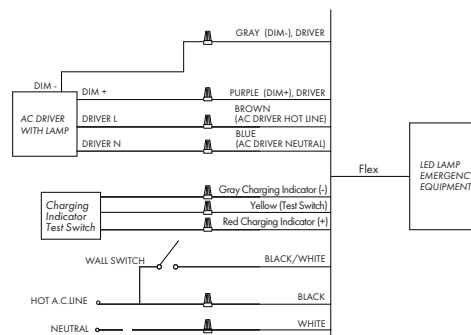

(40W - 300W)

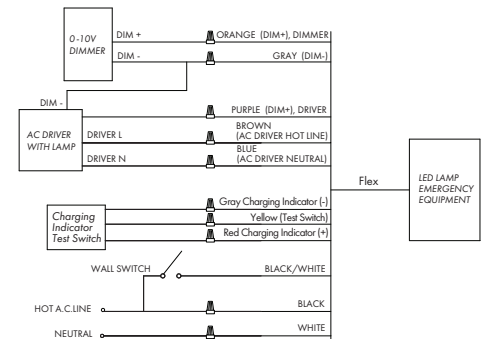

SPECIFICATION (Continued)

Back Pack Side Mount (-EMB-SD/FC):

Eliminates need for long runs back to remote emergency battery location. Installs directly on building surface. Ideal for locations wanting same mounting aesthetics for Emergency and Non-Emergency fixtures without the use of remote Emergency power. Can be fed from recessed wall mounted junction box from the back of fixture or surface conduit from side of fixture.

- Wet location rated
- 120V-347V operation
- Self diagnostic
- Integral surge protector for emergency driver only
- Includes (2) 1/2" NPT knock-outs
- Optional -EMB-BLANK can be used to maintain a common aesthetic when -EMB-FC are used.

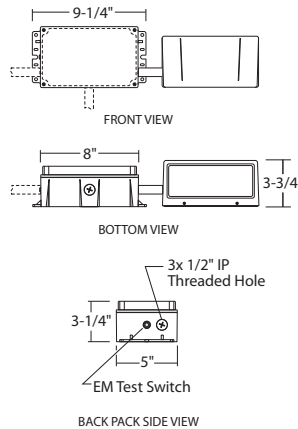

Output Power:	18 Watts (Max)
Input Power:	7 Watts (Max)
Emergency Operation:	≥90 minutes
Operating temp:	0°C/32°F to 50°C/122°F
Input Voltage:	120V-347 VAC
Battery:	Recyclable lithium battery
	24 Hour Recharge
	7-10 Year Life Expectancy

Charge Time:	24 hours
Max Distance:	25'
Weight:	3-3/4 lbs.
Warranty:	5-year
Surge Protection:	Integral 3,000V
Self-diagnostic testing:	Monthly 30 sec. test, Yearly 90 min. test to verify proper emergency operation per life safety code requirements.

(<18W)

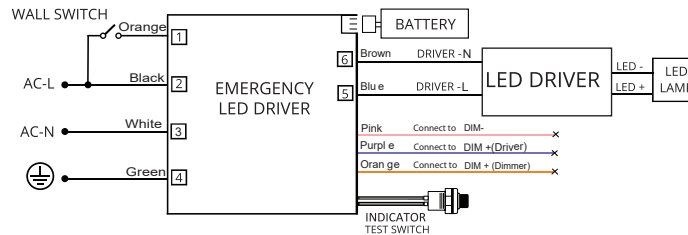

(18W-200W)

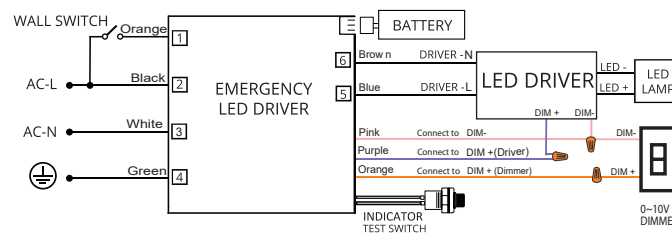

SPECIFICATION (Continued)

Additional Options

Photocell Sensor (-SDL):



Allows for energy savings when illumination is not need during between dawn to dusks.
Cuts off power to LED's during day time or in illuminated environments.

Power Consumption .5W

Voltage: 120V, 277V

On/Off Levels: On @ 0-2fc / Off @ 2fc or more

Warranty: 2-Year / 5,000 Cycles

Sensor Size: 3/8"

Rating: UL/cUL

RGB+W:



15W RGBW LED Module Illuminates surfaces up to 10 feet away.Used for applications desiring a dynamic color changing effect. RGB+W design allows fine-tuned pastel colors and saturated hues without sacrificing illumination brightness. Can be set for static colors or dynamic shows. Multiple control options available with either Wireless Bluetooth control or DMX 512 remote mounted decoders.

On-site commissioning and programing available.

Consult Factory for Layout Assistance and Lead Times.

Electrical

LED Driver: AC 50/60Hz Electronic Direct Current Class 2 driver integrally mounted.

Power Factor > 0.90. See Dimming Section for voltage and wiring.

Minimum Operating Temperature

Standard: -10°C/14°F

SPECIFICATION (Continued)

Dimming Options

ELV and TRIAC Driver 120V (-DIN):

Compatible with electronic low voltage, and 2-Wire incandescent dimmers. Also known as leading edge, Reverse Phase, Forward Phase dimming. Allows smooth dimming down to 5% depending upon the dimmer's limitations.

0-10V Driver 120V/277V (UE-D10):

Compatible with most existing 0-10V systems. Also known as fluorescent or 5-Wire dimming. Allows smooth dimming down to 5% depending upon the dimmer's limitations. Compatible with daylight harvesting controls.

UniDim™ Driver 120V/277V (UE-DUN):

All in one ELV and TRIAC phase dimming (120V only), and 0-10V dimming (120V/277V). Works with most 3-Wire ELV, 2-Wire incandescent and 120V/277V 5-Wire 0-10V fluorescent dimmers.

Incandescent/Phase Wiring
ELV

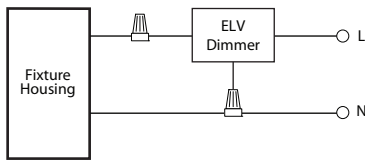

TRIAC

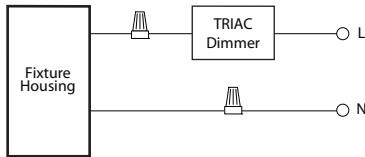

0 - 10V Wiring

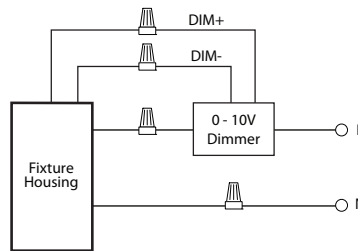

Incandescent/Phase Wiring
ELV

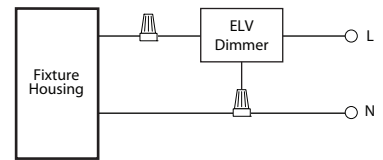

TRIAC

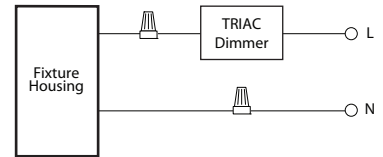

0 - 10V Wiring

