

# WD1Q362EM: 6" SQUARE 1-DIRECTION

WALL EMERGENCY (IP65) 1000LM-2600LM (10W/15W/22W/30W)

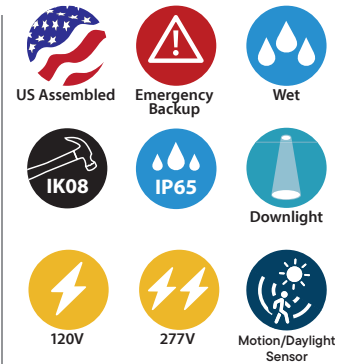
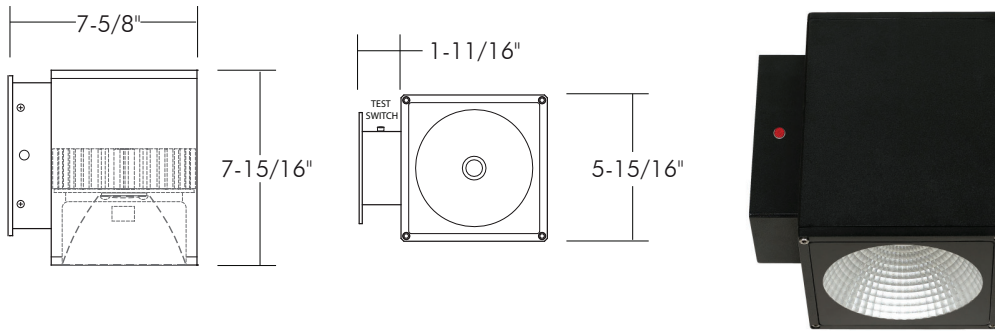

- Illuminated Self-Diagnostic LED test switch
- Uniform, low glare illumination
- Durable, corrosion resistant finish
- Emergency back up available
- Singular COB Light Source
- 800 lm delivered during emergency operation
- 5-year limited warranty
- IK08 Rated
- New Die-Cast Mounting Plate (-WPDC6)

## ORDERING : WD1Q362EMW-L15-B10UE-D10-T27-LVR

### WD1Q362EM

Fixture	Finish	Lumen	Optics	Control	LED	Options
<b>Finish</b>		<b>Optics</b>		<b>Control</b>		<b>LED</b>
White (RAL 9003) <b>W</b>		<i>Standard Beams</i>		Non-Dimming (120V)	<b>Blank</b>	4000K (90 CRI)
Silver (RAL 7037) <b>S</b>		Wide Flood <b>Blank</b>		0-10V Dimming (120V/277V)	<b>UE-D10</b>	2700K (90 CRI)
Bronze (RAL 8019) <b>BZ</b>		Narrow Spot <b>-B10</b>		UniSense - Integral Motion/Photosensor (120V)	<b>-SUN-INT<sup>5</sup></b>	2700K (97 CRI)
Black (RAL 9005) <b>B</b>		Spot <b>-B20</b>		UniSense - Integral Motion/Photosensor (120V/277V)	<b>-SUN-INT-1227<sup>5</sup></b>	3000K (90 CRI)
Light Silver (RAL 7036) <b>LS<sup>1</sup></b>		Flood <b>-B45</b>		Casambi Wireless Dimming (120V/277V)	<b>-DCSM</b>	3000K (97 CRI)
Dark Grey (RAL 7015) <b>DG<sup>1</sup></b>		<i>CleanBeam™ Option</i>		BubblyNet Wireless System (120V/277V)	<b>-DBNT<sup>6</sup></b>	3500K (90 CRI)
Metallic Gold (RAL 1001) <b>MG<sup>1</sup></b>		10° Pencil Beam <b>-CB10<sup>2</sup></b>		SimplySnap Wireless System (120V/277V)	<b>-DSYN<sup>6</sup></b>	5000K (90 CRI)
Metallic Black (RAL 7021) <b>MB<sup>1</sup></b>		15° Clean Beam <b>-CB15<sup>2</sup></b>				
		35° Clean Beam <b>-CB35<sup>2</sup></b>				
<b>Lumen</b>						<b>Options</b>
1000lm (10W) <b>Blank</b>						None <b>Blank</b>
1500lm (15W) <b>-L15</b>						Hex-Cell Louver <b>-LVR<sup>4</sup></b>
2200lm (22W) <b>-L20</b>						Integral Junction Box 1-Entry <b>-JBL, JBR<sup>3</sup></b>
2600lm (30W) <b>-L26</b>						Integral Junction Box 2-Entries <b>-JB2</b>
						Junction Box, Conduit Top Entry <b>-JBT</b>
						BackPack (Empty, Side Mount) <b>-EMB-BLANK-SD</b>
						BackPack (Empty, Face Mount) <b>-EMB-BLANK-FC</b>
						Marine Grade Finish <b>-MGD<sup>1</sup></b>
						Die-Cast Oversized Mounting Plate <b>-WPDC6</b>

<sup>1</sup> Special Order Finish. Minimum order quantity (MOQ) applies. Orders less than MOQ are subject to a special paint set-up fee for the quantity ordered. Extended lead times may apply. Consult Factory.

<sup>2</sup> Special Order. Minimum order quantity (MOQ), extended lead time may apply. Consult Factory.

<sup>3</sup> Must Specify Left or Right, see Page 7 for more details.

<sup>4</sup> (-LVR) Hex-Cell Louver is not compatible with CleanBeam Options (-CB10), (-CB15), (-CB35).

<sup>5</sup> (-SUN-INT) sensor integrated into the reflector. Consult Factory for layout assistance or alternate sensor mounting.

<sup>6</sup> Special Order. Must be ordered with -EMB-BLANK.

Energy Efficient Chip-On-Board (COB) Singular LED Light source provides for smooth uniform light output, eliminating the multiple shadow effect seen by multiple LED source products.

Binned with 3-Step MacAdam Ellipses as recommended by Ansi Standard. Available in 2700k, 3000k, 3500k, 4000k, 5000k, RGBW, and 590nm Amber.

Custom RAL Color: Please note that we appreciate custom finishes. Custom finishes are subject to a special paint setup fee for the quantity ordered. Extended lead times may apply. Consult Factory.

## SPECIFICATION

### Application

This WD1 series single direction wall mount luminaire can be used for both interior and outdoor locations. The single reflector design can be used for direct illumination downward or indirect illumination upward for new construction or retrofit installations. Typical locations are in residential, commercial, and architectural facades and retail spaces that contain walls and/or columns.

### Housing/Arm

Housing and Arm are constructed of one piece rectilinear high grade aluminum extrusions (Alloy 6061 <.04% Cu). Faceplate (with flush mounted tempered glass lens) and end caps are of a robust die cast aluminum alloy sealing the housing (top and bottom) using silicone gaskets. An aluminum alloy mounting plate with a U-bracket installs onto an electrical junction box and secures into the arm with two (2) flat head countersunk phillips head stainless steel screws.

### Mounting:

The standard mounting plate is a 6" high x 4-1/2" plate with a U-Bracket that installs directly onto 3-1/2" or 4" octagonal electrical junction box. (-WPDC6) is a die-cast oversized 6-3/4" high x 4-5/8" plate with a flat bracket designed to mount directly onto a 4" square junction box or a 3-1/2" or 4" octagonal electrical box.

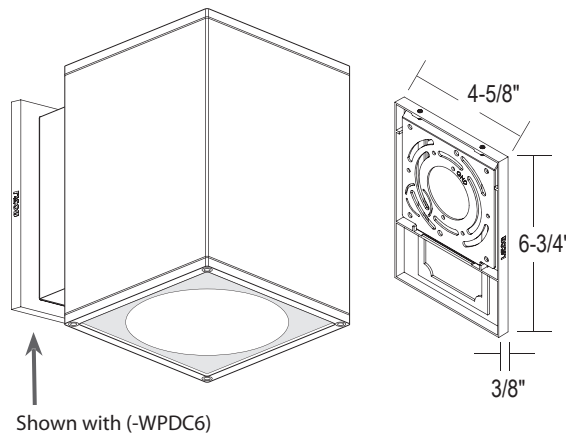

### Finish:

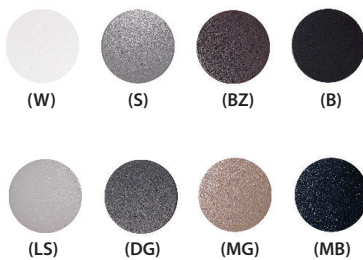

A 7-stage electrostatic, polymer process provides an outdoor textured powder coat finish that delivers outstanding durability, superior anti-aging, resistance to corrosion and UV-degradation. Consult factory for Custom Color. (More Information)

#### Standard Finishes:

White: RAL 9003 (W)  
 Silver: RAL 7037 (S)  
 Bronze: RAL 8019 (BZ)  
 Black: RAL 9005 (B)

#### Special Order Finishes:

Light Silver: RAL 7036 (LS)  
 Dark Gray: RAL 7015 (DG)  
 Metallic Gold: RAL 1001 (MG)  
 Metallic Black: RAL 7021 (MB)

**SPECIFICATION (Continued)**

**Certifications and Listings:**



ETL / cETL Listed to UL1598 and UL8750 standards.

Suitable wet locations. (IP65)

Assembled in USA.

IK08 rated for impact resistance.

**Caution:**

LITON recommends use of surge protectors on the power entering LED Housings.  
Surge damage is not covered by warranty.

**Warranty**

Covered by a 5-Year Warranty to be free of defects in materials and craftsmanship.  
Recommended for applications where ambient temperatures do not exceed 35°C,  
installations exceeding this temperature will result in reduced LED lamp life and a voided  
warranty.

**Optics**

Multifaceted aluminum reflector produces low glare illumination with multiple  
light control options.

**Standard Beam:**

Used for maximum light output and visible field angle.

**CleanBeam™:**

Used for a direct uniform light output with minimized field angle and to enhance building  
aesthetics.

**LED**

COB (Chip on Board) singular LED light source provides for smooth, uniform light output,  
eliminating the imaging produced by multiple LED source optics.

**Lumen Maintenance:**

Lumen Maintenance is minimum 50,000 hours L70 life based on ANSI TM-21 calculations from  
LM80 standardized test results.

**Lumen Options (Nominal):**

- 1000lm (10W) (Blank)
- 1500lm (15W) (-L15)
- 2200lm (22W) (-L20)
- 2600lm (30W) (-L26)

**Color Temperature:**

Binned with 4-step MacAdam ellipses as per ANSI Standard recommendation.

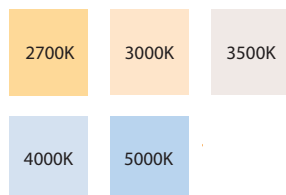

COLOR TEMP:	2700K	3000K	3500K	4000K	5000K
CRI:	90, 97	90, 97	90	90	90

## SPECIFICATION (Continued)

### Emergency Options

Emergency LED Battery Back-up available, remotely mounted adjacently by the installer. When AC power fails, the device immediately switches to the emergency mode, operating the LEDs for a minimum of 90 minutes. Remote test switch and plate cover included. Optional Generator Transfer Device switches the driver to auxiliary generator power during the loss of normal AC power, (recommended for applications requiring individual circuit switching).

### INTEGRAL EMERGENCY BATTERY (UE-D10-EM): 10W

For installation away from the surface of the building in remote hidden location.

- Hidden Emergency Equipment
- Must be installed in Dry Locations
- 10W constant output to LED lamp

**Not rated for outdoor mounting. Damp location rated.**

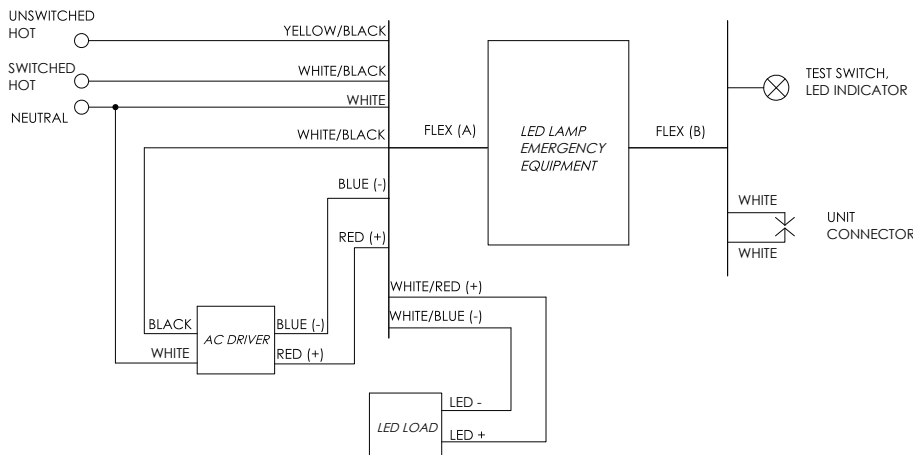

Input Voltage:	120-277VAC/60Hz
Output Voltage:	10W
Wattage:	10W
Switching Time:	<3s
Charging Time:	12h
Operating Time:	90 minutes
Minimum Temperature:	0°C
Maximum Temperature:	48°C
Maximum Lumens:	800lm
Self-Diagnostic:	Yes

### Additional Options

Optional J-Box (Direct Conduit Entry):

For use with mounting locations without a recessed junction box. Allows for direct mounting to building surface. Arm may be configured for up to 3 conduit entries (1/2" total; 2 on the sides, 1 on top).

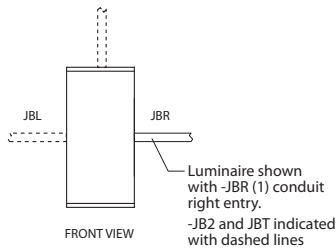

Configure as:

- JBL, JBR: (1) conduit entry from left or right looking at fixture
- JB2 (2) conduit entry on sides
- JBT (1) conduit entry on top

Hexcell Louver (-LVR):

3 mm /.125" (size of the cells) - matte black finish, 45° glare cutoff, unframed.



## SPECIFICATION (Continued)

### Electrical

LED Driver: AC 50/60Hz Electronic Direct Current Class 2 driver integrally mounted.  
 Power Factor > 0.90. See Dimming Section for voltage and wiring.  
 -10 ° C/14 ° F Starting Temp

### Control Options

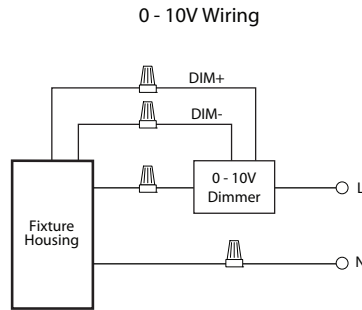

#### 0-10V Driver 120V/277V (UE-D10):

Compatible with most existing 0-10V systems. Also known as fluorescent or 5-Wire dimming. Allows smooth dimming down to 5% depending upon the dimmer's limitations. Compatible with daylight harvesting controls.

### Marine Grade

The fixture features a marine-grade textured powder coat finish engineered to withstand extreme environmental conditions, including prolonged exposure to UV radiation, salt air, and moisture, which are prevalent in coastal and high-humidity environments.

A multi-stage surface preparation, finishing, and curing process ensures maximum adhesion, durability, and corrosion resistance. The coating system undergoes rigorous salt spray (ASTM B117) testing, overbake resistance verification, and pencil hardness testing to validate its robustness against degradation.

The marine-grade powder coat is applied as a 30–50 µm bottom layer, providing a strong anti-corrosion foundation. This is further enhanced by a surface coat using a standard architectural-grade powder application with a total thickness of 80–120 µm, ensuring superior resistance to wear, impact, and environmental stressors.

## Unisense™ PROGRAMMABLE MOTION + DAYLIGHT (-SUN-INT, -SUN-INT-1227)

- Microwave and PIR (Passive Infrared) sensors depending on option
- Daylight harvesting
- Dusk/dawn sensing capabilities
- Motion Sensor

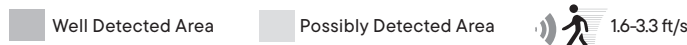
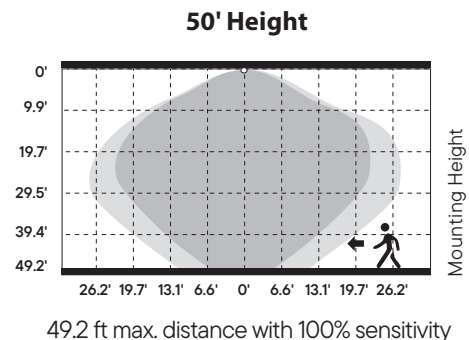
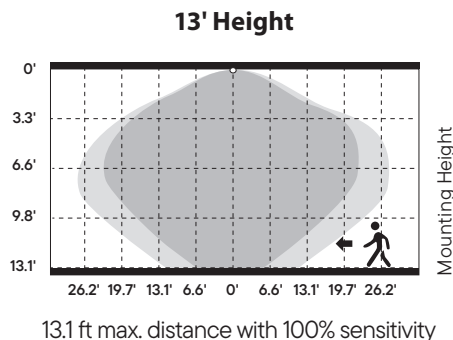

## Emergency Battery, Backpack Side Mount (-EMB-FC or -EMB-SD):

Eliminates need for long runs back to remote emergency battery location. Installs directly on building surface. Ideal for locations wanting same mounting aesthetics for Emergency and Non-Emergency fixtures without the use of remote Emergency power. Can be fed from recessed wall mounted junction box from the back of fixture or surface conduit from side of fixture.

- Wet location rated.
- 120V-347V operation.
- Self diagnostic.
- Integral surge protector for emergency driver only.
- Includes (2) 1/2" NPT knock-outs.
- Optional -EMB-BLANK can be used to maintain a common aesthetic when -EMB-FC are used.



Shown with EMB-FC Option

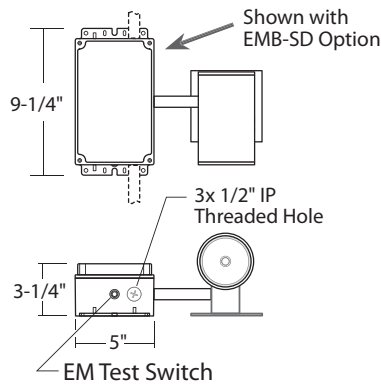

Output Power:	18 Watts (Max)
Input Power:	7 Watts (Max)
Emergency Operation:	≥90 minutes
Operating temp:	0°C/32°F to 50°C/122°F
Input Voltage:	120V-347 VAC
Battery:	Recyclable lithium battery 24 Hour Recharge 7-10 Year Life Expectancy
Charge Time:	24 hours
Max Distance:	25'
Weight:	3-3/4 lbs.
Warranty:	5-year
Surge Protection:	Integral 3,000V
Self-diagnostic testing:	Monthly 30 sec. test, Yearly 90 min. test to verify proper emergency operation per life safety code requirements.

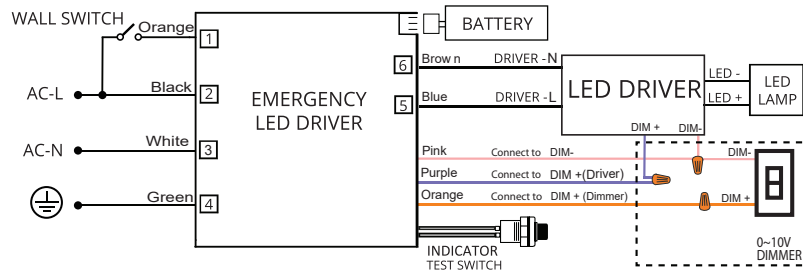

PHOTOMETRY – WD1Q360B (L26)

Footcandles On Wall

5.0 fc 2.0 fc 1.0 fc .5 fc

**STANDARD BEAM – Wide Flood (Blank)**  
3 ft Grid

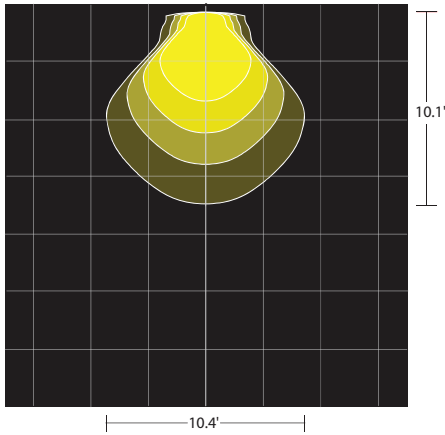

**CLEANBEAM™ – (-B02)**  
3 ft Grid

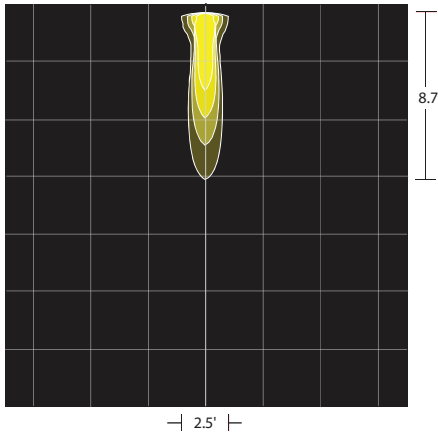

**CLEANBEAM™ – (-CB20)**  
3 ft Grid

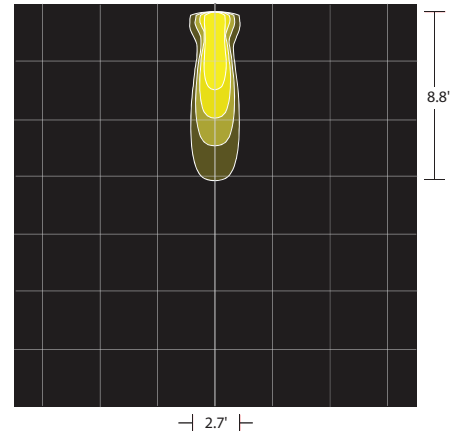

**CLEANBEAM™ – (-CB35)**  
3 ft Grid

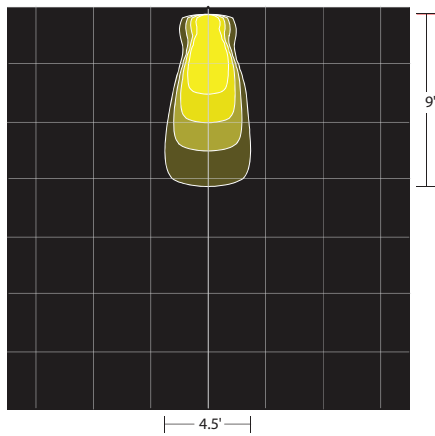

**SPECIALTY BEAM – Wall Wash (-BWW)**  
3 ft Grid

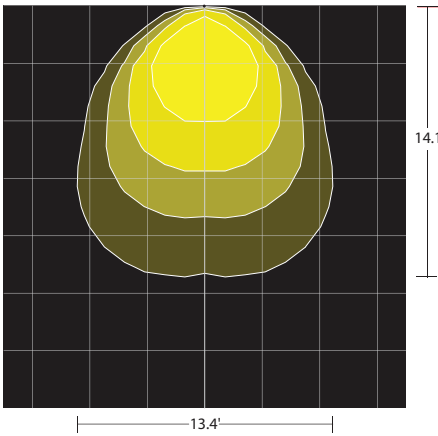

Footcandles On Wall and Ground

5.0 fc 2.0 fc 1.0 fc .5 fc

**STANDARD BEAM – Wide Flood (Blank)**  
3 ft Grid

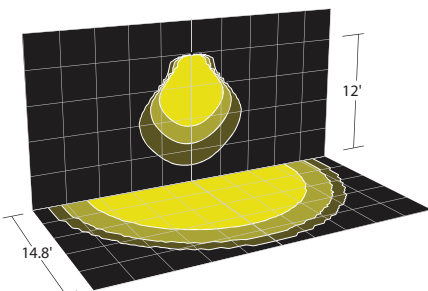

**SPECIALTY BEAM – Type II (-BII)**  
3 ft Grid

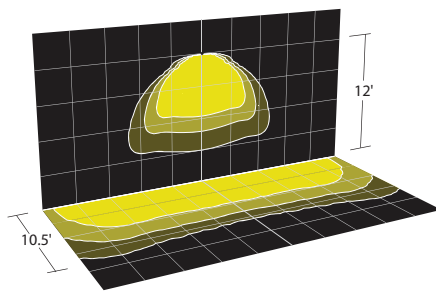

**SPECIALTY BEAM – Type IV (-BIV)**  
3 ft Grid

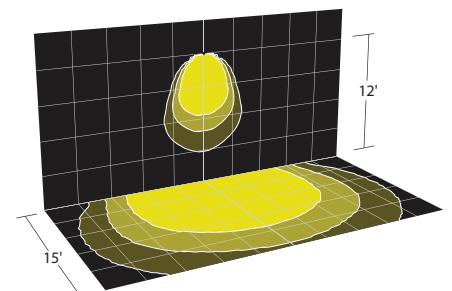

2023.02.09 rev.2

PHOTOMETRY – WD1Q360B (L26) (Cont.)

Footcandles On Ground (2 - Fixture Overlap)

5.0 fc 2.0 fc 1.0 fc .5 fc

STANDARD BEAM – WIDE FLOOD (Blank) 8' Mounting

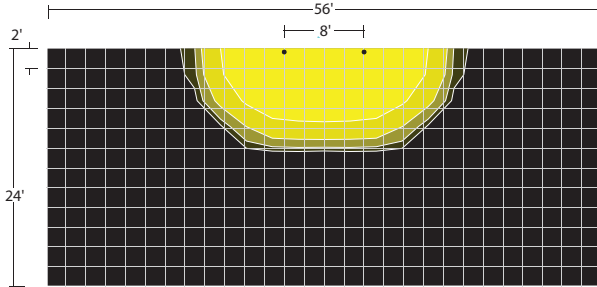

STANDARD BEAM – WIDE FLOOD (Blank) 16' Mounting

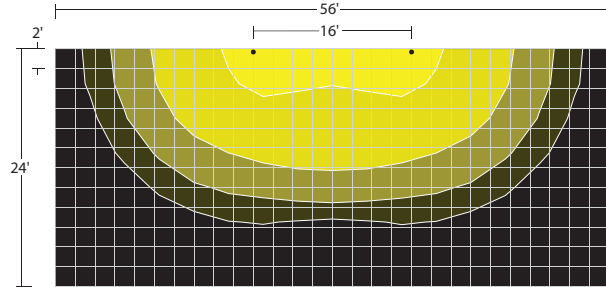

SPECIALTY BEAM – TYPE IV (-BIV) 8' Mounting

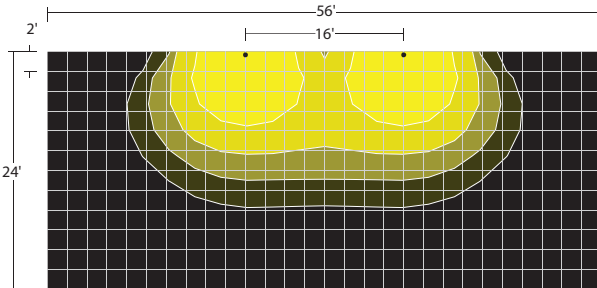

SPECIALTY BEAM – TYPE IV (-BIV) 16' Mounting

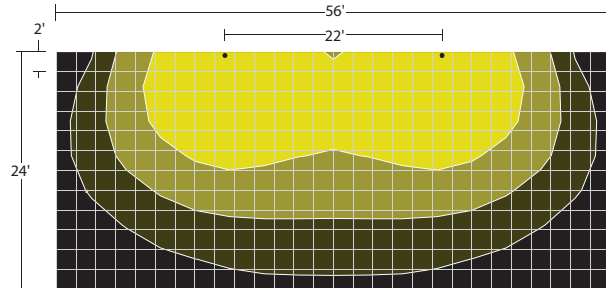

SPECIALTY BEAM – TYPE II (-BII) 8' Mounting

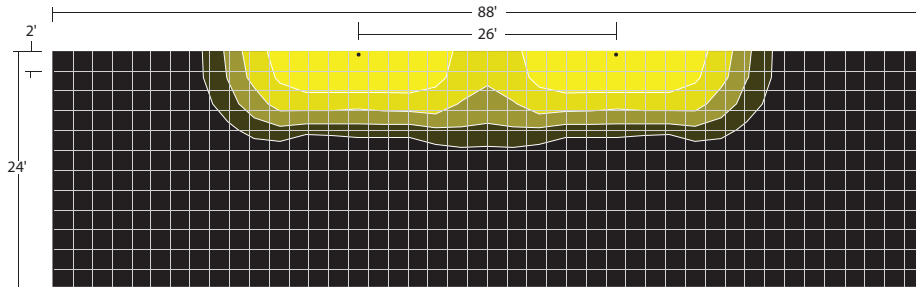

SPECIALTY BEAM TYPE II (-BII) 16' Mounting

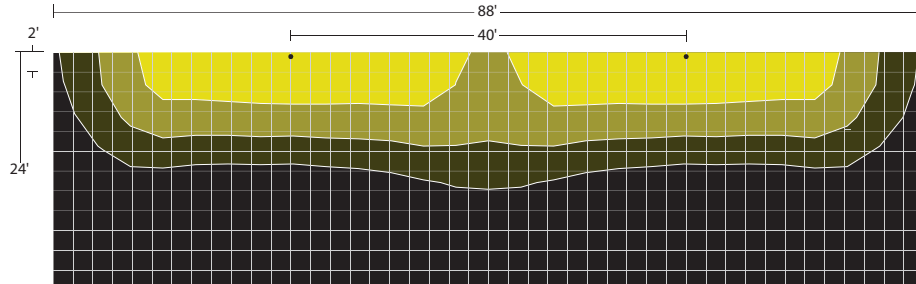

## LUMEN OUTPUT / LPW /BUG RATING

LM	W	Beam Spread	-T27 (2700K, 90 CRI)						-T30 (3000K, 90 CRI)						-T35 (3500K, 90 CRI)						Blank (4000K, 90 CRI)						-T50 (5000K, 80 CRI)					
			LM	LPW	cd	B	U	G	LM	L/W	cd	B	U	G	LM	LPW	cd	B	U	G	LM	LPW	cd	B	U	G	LM	LPW	cd	B	U	G
1000 lm	14.3	Wide FL	958	67	678	1	0	0	997	70	906	1	0	0	1011	71	716	1	0	0	1013	71	717	1	0	0	1207	84	855	1	0	0
		-B02	224	16	423	1	0	0	233	16	440	1	0	0	236	17	447	1	0	0	237	17	447	1	0	0	282	20	533	1	0	0
		-CB20	265	19	482	1	0	0	276	19	502	1	0	0	280	20	509	1	0	0	281	20	510	1	0	0	334	23	607	1	0	0
		-CB35	403	28	509	1	0	0	420	29	530	1	0	0	425	30	538	1	0	0	426	30	539	1	0	0	508	36	642	1	0	0
		-B10	1134	79	5609	2	0	0	1180	83	5840	2	0	0	1197	84	5921	2	0	0	1199	84	5933	2	0	0	1429	100	7070	2	0	0
		-B20	977	68	4490	2	0	0	1017	71	6633	2	0	0	1031	72	4740	2	0	0	1033	72	4749	2	0	0	1231	86	5659	2	0	0
		-B45	968	68	1891	2	0	0	1008	70	2448	2	0	0	1022	71	1997	2	0	0	1024	72	2001	2	0	0	1220	85	2384	2	0	0
		-BII	951	67	754	1	0	0	990	69	785	1	0	0	1004	70	796	1	0	0	1006	70	798	1	0	0	1199	84	951	1	0	0
		-BWW	906	63	613	1	0	0	943	66	638	1	0	0	956	67	647	1	0	0	958	67	648	1	0	0	1142	80	772	1	0	0
-BIV	906	63	613	1	0	0	943	66	638	1	0	0	956	67	647	1	0	0	958	67	648	1	0	0	1142	80	772	1	0	0		
-L15 (1500 lm)	13.9	Wide FL	1281	90	907	1	0	0	1334	96	709	1	0	0	1352	97	957	1	0	0	1355	97	959	1	0	0	1615	116	1143	1	0	0
		-B02	283	20	619	1	0	0	294	21	644	1	0	0	299	21	653	1	0	0	299	22	654	1	0	0	356	26	780	1	0	0
		-CB20	336	23	610	1	0	0	350	25	635	1	0	0	355	26	644	1	0	0	355	26	645	1	0	0	423	30	769	1	0	0
		-CB35	509	36	643	1	0	0	530	38	670	1	0	0	537	39	679	1	0	0	538	39	680	1	0	0	641	46	811	1	0	0
		-B10	1264	88	6257	2	0	0	1316	95	6514	2	0	0	1335	96	6605	2	0	0	1337	96	6618	2	0	0	1594	115	7886	2	0	0
		-B20	1316	92	6050	2	0	0	1370	99	4534	2	0	0	1389	100	6387	2	0	0	1392	100	6399	2	0	0	1659	119	7626	2	0	0
		-B45	1303	91	2545	2	0	0	1356	98	1990	2	0	0	1375	99	2687	2	0	0	1378	99	2692	2	0	0	1642	118	3208	2	0	0
		-BII	1241	87	984	1	0	0	1292	93	1025	1	0	0	1310	94	1039	1	0	0	1313	94	814	1	0	0	1564	113	1240	1	0	0
		-BWW	1137	80	769	1	0	0	1184	85	801	1	0	0	1201	86	812	1	0	0	1203	87	814	1	0	0	1431	103	968	1	0	0
-BIV	1137	80	769	1	0	0	1184	85	801	1	0	0	1201	86	812	1	0	0	1203	87	814	1	0	0	1433	103	970	1	0	0		
-L20 (2000 lm)	19.5	Wide FL	1745	122	1236	1	0	0	1817	93	830	1	0	0	1843	94	1304	1	0	0	1846	95	1307	1	0	0	2200	113	1557	1	0	0
		-B02	463	32	954	1	0	0	482	25	993	1	0	0	489	25	1007	1	0	0	490	25	1009	1	0	0	584	30	1202	1	0	0
		-CB20	549	38	997	1	0	0	571	29	1038	1	0	0	579	30	1052	1	0	0	581	30	1054	1	0	0	692	35	1257	1	0	0
		-CB35	834	58	1055	1	0	0	869	45	1098	1	0	0	881	45	1113	1	0	0	882	45	1116	1	0	0	1052	54	1329	1	0	0
		-B10	2022	141	9994	2	0	0	2106	108	10405	2	0	0	2135	109	10551	2	0	0	2139	110	10571	2	0	0	2549	131	12597	2	0	0
		-B20	1759	123	7728	2	0	0	1831	94	5913	2	0	0	1857	95	8158	2	0	0	1860	95	8173	2	0	0	2217	114	9740	2	0	0
		-B45	1776	124	3469	2	0	0	1849	95	2775	2	0	0	1874	96	3662	2	0	0	1878	96	3669	2	0	0	2238	115	4372	2	0	0
		-BII	1998	140	1584	1	0	0	2080	107	1649	1	0	0	2109	108	1672	1	0	0	2113	108	1676	1	0	0	2518	129	1997	1	0	0
		-BWW	1870	131	1265	1	0	0	1946	100	1317	1	0	0	1974	101	1335	1	0	0	1977	101	1338	1	0	0	2356	121	1594	1	0	0
-BIV	1870	131	1265	1	0	0	1946	100	1317	1	0	0	1974	101	1335	1	0	0	1977	101	1338	1	0	0	2356	121	1594	1	0	0		
-L26 (2600 lm)	29.3	Wide FL	2246	157	1590	1	0	0	2339	80	1114	1	0	0	2372	81	1679	1	0	0	2376	81	1682	1	0	0	2832	97	2005	1	0	0
		-B02	601	42	1249	1	0	0	626	21	1301	1	0	0	634	22	1319	1	0	0	636	22	1321	1	0	0	757	26	1575	1	0	0
		-CB20	712	50	1294	1	0	0	742	25	1347	1	0	0	752	26	1366	1	0	0	754	26	1368	1	0	0	898	31	1631	1	0	0
		-CB35	1082	76	1368	1	0	0	1126	38	1424	1	0	0	1142	39	1444	1	0	0	1144	39	1447	1	0	0	1364	47	1724	1	0	0
		-B10	2494	174	12307	2	0	0	2597	89	12812	2	0	0	2633	90	12992	2	0	0	2638	90	13016	2	0	0	3144	107	15512	2	0	0
		-B20	2306	161	10153	2	0	0	2401	82	7653	2	0	0	2434	83	10718	2	0	0	2439	83	10738	2	0	0	2907	99	12797	2	0	0
		-B45	2315	162	4522	2	0	0	2410	82	3725	2	0	0	2443	83	4773	2	0	0	2448	84	4782	2	0	0	2917	100	5699	2	0	0
		-BII	2567	179	2035	1	0	0	2672	91	2119	1	0	0	2710	92	2149	1	0	0	2715	93	2153	1	0	0	3235	110	2566	1	0	0
		-BWW	2404	168	1626	1	0	0	2502	85	1693	1	0	0	2537	87	1716	1	0	0	2542	87	1720	1	0	0	3024	103	2046	1	0	0
-BIV	2404	168	1626	1	0	0	2502	85	1693	1	0	0	2537	87	1716	1	0	0	2542	87	1720	1	0	0	3030	103	2049	1	0	0		