

WS830C : 14" ROUND BULLS-EYE

CEILING LUMINAIRE - OUTDOOR SURFACE MOUNT
600LM-1500LM (10W/20W)



- Glare-Free Soft Diffused Illumination
- Impact Resistant Diffusing Lens
- Tamper Proof Hardware
- 80+CRI Light Quality
- ADA Compliant
- IP65 Rated

ORDERING : WS830CB-L06-T30

WS830C

Fixture	Finish	Lumens	Control	Color Temperature
Finish	Lumens	Control	Color Temperature	
Black B	10W/600lm	-L06	Non-Dimming (120V)	Blank 3000K -T30
White W ³	20W/1500lm	-L15	Non-Dimming (120V/277V)	UE 3500K -T35
Silver S ³			0-10 Dimming (120V/277V)	UE-D10 4000K -T40
Bronze BZ ³			Remote Emergency Backup (120V/277V)	UE-EM 5000K -T50
			Casambi Wireless Dimming (120V/277V)	Color Changing -RGB+W ^{1,4}
				-DCSM ¹
			BubblyNet Wireless System (120V/277V)	-DBNT ¹
			SimplySnap Wireless System (120V/277V)	-DSYN ²

¹ Special Order. Consult Factory.

² Special Order. Sent with surface mount JBOX to allow for direct-conduit entry.

³ Special Order Finish. Minimum order quantity (MOQ) applies. Orders less than MOQ are subject to a special paint set-up fee for the quantity ordered. Extended lead times may apply. Consult Factory.

⁴ Remote Power Supplies and Control Gear required. Available with Wireless Bluetooth Casambi or DMX 512 control. Consult Factory for Details.

Custom RAL Color: Please note that we appreciate custom finishes. Custom finishes are subject to a special paint setup fee for the quantity ordered. Extended lead times may apply. Consult Factory.

COMPATABILITY

SUN-RMT

Remote Unisense™

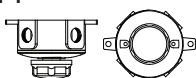

WS830C: 14" ROUND BULLS-EYE

CEILING LUMINAIRE - OUTDOOR SURFACE MOUNT

600LM-1500LM (10W/20W)

SPECIFICATION

Application

Ceiling Mount Surface Luminaire are ideal for indoor or outdoor applications in residential, commercial, or architectural installations that require the fixture to integrate into the design of the structure. The ceiling mount surface can be used to direct and guide as well as supply lighting for security.

Housing

Constructed from one piece of high grade die cast aluminum with a powder coat finish. Includes an integral wiring compartment and silicone gasket. One (1) power entry hole (1/2-14 NPSM) provided.

Faceplate

A round, cross bar, one-piece, high grade die cast aluminum with a high corrosion-resistant powder coat finish and semi-translucent UV stabilized polycarbonate opal lens. Faceplate is secured to housing by four (4) captive, tamper resistant, stainless steel screws.

Through Wiring

A maximum of four (4) No. 12 AWG conductors (plus ground wire).

Listing

ETL / cETL Listed, suitable for wet locations and for all types of construction, covered ceiling mount. ADA compliant when installed per ADA Requirements. Assembled in USA.

Electrical

AC 50/60Hz Electronic Direct Current Class 2 driver integrally mounted. Power Factor > 0.90. Accessible from above or below ceiling.
Minimum Operating Temperature: -20°C/-4°F

Emergency Options

Emergency LED Battery Back-Up available, remotely mounted adjacent to housing by installer. When AC power fails, the device immediately switches to the emergency mode, operating the LEDs for a minimum of 90 minutes. Remote test switch, plate cover and junction box included.

Lumen Maintenance

Minimum 50,000 hours L70 life based on ANSI TM-21 calculations from LM80 standardized test results. See ordering guide for delivered lumens.

Control

0-10V dimming option (-D10) works with most 5-Wire 0-10V dimmers. Factory qualified for use with Leviton IP710-DLX and Lutron NTFTV-WH.

Warranty

Covered by a 5-Year Warranty to be free of defects in materials and craftsmanship.

WS830C: 14" ROUND BULLS-EYE CEILING LUMINAIRE - OUTDOOR SURFACE MOUNT 600LM-1500LM (10W/20W)

SPECIFICATION (Continued)

Finish

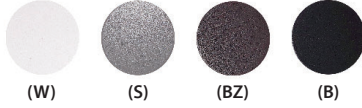

Available in Black, White, Silver and Bronze.

Lumens

Available in 10W/ 600lm and 20W/ 1500lm.

Color Temperature



Available in 3000K, 3500K, 4000K, 5000K and Color Changing (Consult Factory).



LED Details

10W 600 Lumen Package

Color Rendering Index (CRI): 80

Color Temperature: 3,000K

Lamp Equivalent: (1) 26W CFL, 150W A-Lamp

20W 1500 Lumen Package

Color Rendering Index (CRI): 80

Color Temperature: 3,000K

Lamp Equivalent: (1) 42W CFL, 150W A-Lamp.

WS830C: 14" ROUND BULLS-EYE CEILING LUMINAIRE - OUTDOOR SURFACE MOUNT 600LM-1500LM (10W/20W)

SPECIFICATION (Continued)

RGB+W:



CASAMBI

15W RGB+W LED Module Illuminates surfaces up to 10 feet away. Used for applications desiring a dynamic color changing effect. RGB+W design allows fine-tuned pastel colors and saturated hues without sacrificing illumination brightness. Can be set for static colors or dynamic shows. Multiple control options available with either CASAMBI Wireless Bluetooth control or DMX 512 remote mounted decoders.

On-site commissioning and programming available.

Consult Factory for Layout Assistance and Lead Times.

COLOR	CCT/WAVELENGTH	POWER
Red	640nm	3.1W
Green	520nm	3.1W
Blue	450nm	3.1W
White	2700K	3.1W

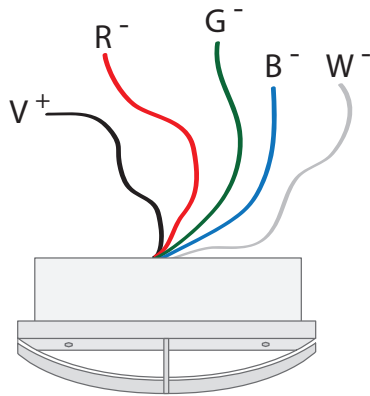

Remote Power Supply	Controls	Wattage
LD5-RGBW-RMTJBX	Remote Mounted Decoder -DMX512	15W -W15
	Wireless Bluetooth Control -CASAMBI	30W -W30
		60W -W60
		96W -W96

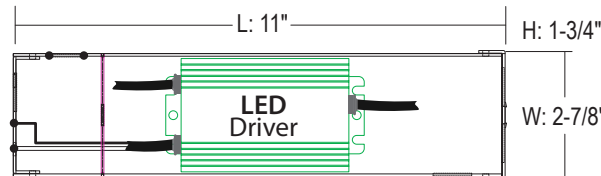

Junction Box Dimensions: 11" x 2-7/8" x 1-3/4" (LxWxH)

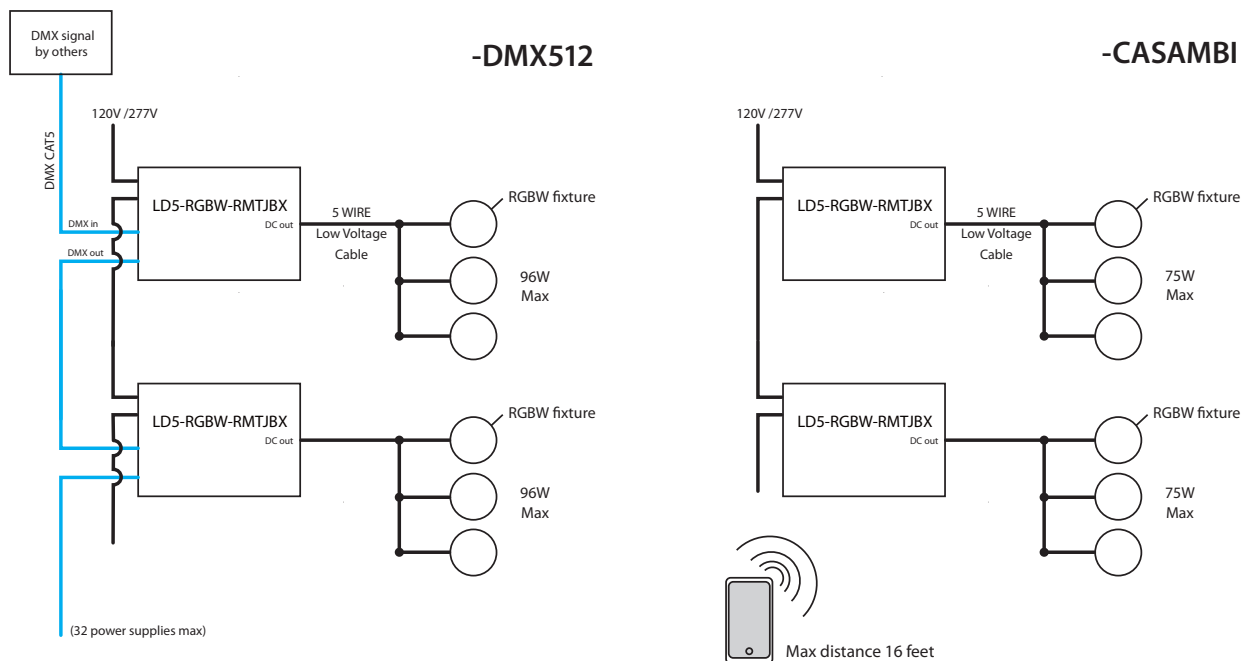

NOTE: Power supply must be placed in dry locations only. 100 feet max for 5 wire low voltage cable 18AWG.

WS830C: 14" ROUND BULLS-EYE

CEILING LUMINAIRE - OUTDOOR SURFACE MOUNT
600LM-1500LM (10W/20W)

PHOTOMETRY

WS8-L06-T40 - 600lm - 4000K

System Power	:12.8W	Multipliers	
Test Date	:7/2016	5000K	1.07
Beam Angle 50%	:110.4°	3000K	0.97
Field Angle 10%	:157.9°		
Color Temperature	:3,876K		
CRI	:85.8		
R9 Value	:31.0		
Lumens Delivered	:989Lm		
CBCP	:358cd		
Power Factor	:0.99		

CANDELA TABULATION

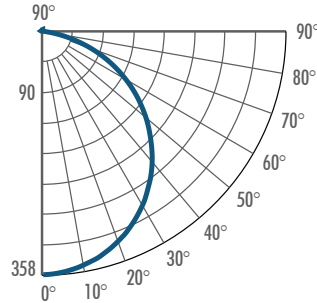

FOOTCANDLE DISTRIBUTION

Height	Beam Diameter	FC
3.3'	9.4'	33.3
6.6'	18.9'	8.3
9.8'	28.3'	3.7
13.1'	37.7'	2.1
16.4'	47.2'	1.3

WS8-L15-T40 - 1500lm - 4000K

System Power	:16.9W	Multipliers	
Test Date	:7/2016	5000K	1.07
Beam Angle 50%	:112.3°	3000K	0.97
Field Angle 10%	:160.2°		
Color Temperature	:3795K		
CRI	:85.8		
R9 Value	:27.0		
Lumens Delivered	:1341Lm		
CBCP	:473cd		
Power Factor	:0.99		

CANDELA TABULATION

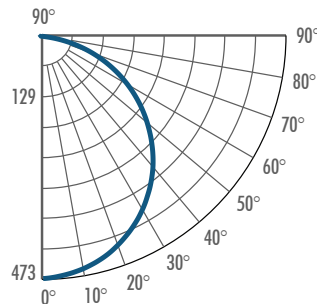

FOOTCANDLE DISTRIBUTION

Height	Beam Diameter	FC
3.3'	9.8'	43.9
6.6'	19.6'	11.0
9.8'	29.4'	4.9
13.1'	39.1'	2.7
16.4'	48.9'	1.8