

SAVE THESE INSTRUCTIONS

Keep these instructions in a safe place for future use/reference.

CATALOG # : DL4P : Cylo Cylinder Canopy Mount Pendant

Important: Please read and understand all instructions completely before installing this fixture.

WARNING: Fixture installation (and use) and all electrical connections must be in accordance with local and National Electrical Codes (N.E.C.) rules, regulations and standards. If you are unfamiliar with installing fixture(s), accessories and/or electrical wiring have a qualified licensed electrician install this fixture for you. Fixture should be installed by a qualified electrician.

WARNING: RISK OF SHOCK. House electric current can cause painful shock or serious injury.

WARNING: Always disconnect power before fixture installation, wiring, or maintenance.

WARNING: Before starting the wire connections, disconnect the power by turning off the circuit breaker or removing the fuse at the fuse panel. Turning the power off using the light switch is not sufficient to prevent electrical shock.

This luminaire must be connected with supply wire/conductors rated at 90°C. Most dwellings built before 1985 have supply wire rated at 60°C; consult a qualified electrician before installing.

WARNING: Before service insure fixture is cool to touch.

WARNING: Check fixture for input voltage before connecting power to fixture.

WARNING: RISK OF SHOCK. This fixture is suitable for dry locations only.





WARNING: Do not install any fixture or assembly (etc.) closer than 6" from any curtain, or similar combustible material.

Fixture must be installed on a circuit protected by Ground Fault Circuit Interrupter (GFCI).

Install LED fixture(s)/LED driver(s) only on their own circuit. Do not mix any other products (Incandescent, Compact Fluorescent, H.I.D. products/fixtures, etc...) with LED fixture(s)/LED driver(s) on a single circuit.

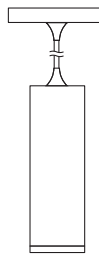
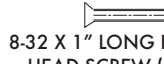
Do not use any other electrical equipment (example: surge protector photocell, etc.) that is not (rated) for use with LED fixture(s)/LED driver(s) on the same circuit as LED fixture(s)/LED driver(s).

Install remote surge protector(s) (by others, goes on the circuit with nothing between the surge protector and the LED fixture(s)/LED driver(s)), if the fixture is not already installed with a surge protector, to help remove power surges that may harm LED fixture(s), appropriate for the installation. Periodically check and make sure that your remote surge protector(s) are in good working order.

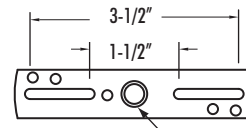
Components / Parts	Components Dimensions	Tools Required
 <p>DL4P fixture (1) (with 5" round Canopy)</p>  <p>8-32 X 1" LONG FLAT HEAD SCREW (2)</p>  <p>8-32 X 1" LONG PAN HEAD SCREW (2)</p>  <p>WIRE NUTS (4)</p>  <p>8-32 CAP NUT (1)</p>  <p>BAR MOUNTING BRACKET (BMB) (1)</p>	 <p>HOLE FOR CORD</p> <p>BAR MOUNTING BRACKET (ALL SLOTS ARE 0.193" WIDE) #8 screw Max</p>	<ul style="list-style-type: none"> • Phillips Head Screwdriver • Wire Connectors • Hardware (screws, nuts, etc.) • DO NOT USE POWER TOOLS. ONLY USE HAND TOOLS.

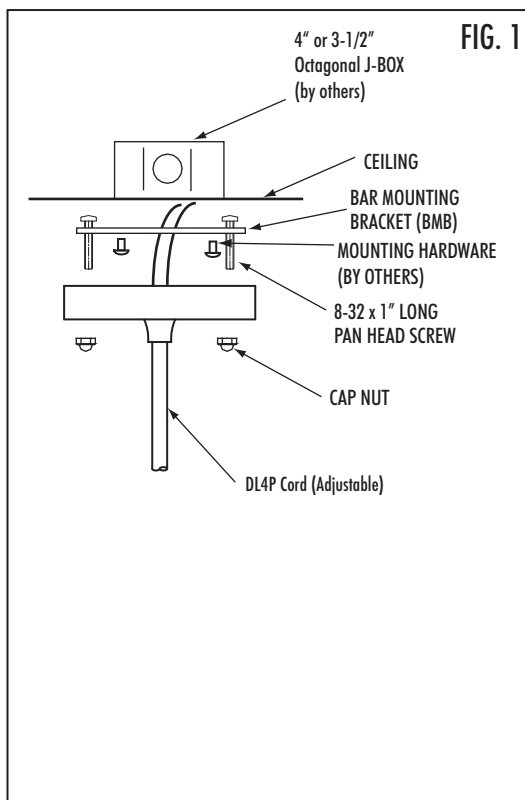

FIXTURE INSTALLATION

1. Remove Bar Mounting Bracket (BMP) from Canopy.
2. Bar Mounting Bracket (BMP) fits to all standard electrical junction boxes that have 1-1/2" to 3-1/2" hole/screw spacing (see above dimensions), for example: 3-1/2" & 4" octagonal j-boxes. Other j-boxes may also fit UMP. Make sure j-box will fit slots or holes on BMP. Secure BMB to j-box (by others) with mounting hardware (by others).
3. Install wiring and j-box in ceiling, if needed.
3. Secure (2) 8-32 x 1" long pan head screws in Bar Mounting Bracket.
4. Secure Bar Mounting Bracket (BMP) to j-box (by others) with appropriate hardware (by others) (FIG 2).
5. If shortening the cord in the canopy pull cord up through canopy to desired length and tie a knot (or use a strain relief - by others, as needed) inside the canopy to prevent the cord from slipping down through the canopy.
6. Connect the power supply wiring (from j-box) to fixture wiring in j-box. See "Wiring" instructions below.
7. Align the (2) 8-32 x 1" screws in the BMB through the canopy and secure with cap nuts.

RELAMPING Return fixture to Liton for servicing/replacing LED and LED drivers.

WIRING

NOTE: Check fixture for input voltage before connecting power to fixture. Connect wiring in j-box. For dimming information (wiring diagrams, chart, etc.) see fixture's website page.

1. Connect ground wire (green or bare copper/aluminum) from the supply circuit to the ground wire (green or bare copper) /screw/connector from the fixture.
2. Connect the neutral (common) wire from the power supply circuit to the neutral wire from the fixture.
3. Connect the main voltage supply wire (line/lead) from the power supply to the line (lead) wire from the fixture.
4. Secure connection using UL Listed wire nuts/connectors and then with UL Listed Electrical tape (by others), as required, appropriate for the connection.