

## SAVE THESE INSTRUCTIONS

CATALOG # LCMPD-BVL-5/7Q - LumenPad Square LED Downlight Surface Mount **Keep these instructions in a safe place for future use/reference.**

### Important: Please read and understand all instructions completely before installing this fixture.

**WARNING:** Fixture installation (and use) and all electrical connections must be in accordance with local and National Electrical Codes (N.E.C.) rules, regulations and standards. If you are unfamiliar with installing fixture(s), accessories and/or electrical wiring (consult a qualified electrician or local electrical inspector, and check your local electrical code) have a qualified licensed electrician install this fixture for you. Fixture should be installed by a qualified electrician.

**WARNING: RISK OF SHOCK.** House electric current can cause painful shock or serious injury.

**WARNING:** Always disconnect power before fixture installation, wiring, or maintenance.

**WARNING:** Before starting the wire connections, disconnect the power by turning off the circuit breaker or removing the fuse at the fuse panel, in order to prevent possible shock. Turning the power off using the light switch is not sufficient to prevent electrical shock.

Ground the fixture to avoid potential electric shocks and to ensure reliable starting.

Double-check all connections to be sure they are tight and correct.

Wear rubber soled shoes and work on a sturdy (wooden) ladder or other lifting device.

This luminaire must be connected with supply wire/conductors rated at 90°C. Most dwellings built before 1985 have supply wire rated at 60°C; consult a qualified electrician before installing.

**WARNING:** Before service insure fixture is cool to touch.

**WARNING:** Check fixture for input voltage before connecting power to fixture.

**WARNING: RISK OF CUTS** Some metal parts in the fixture may have sharp edges. To prevent cuts and scrapes, wear gloves when handling the parts.

Account for small parts and destroy packing material, as these may be hazardous to children.

Make sure you check all hole ceiling cutouts (sizes) before cutting holes in ceilings.

**WARNING: RISK OF SHOCK.**

This fixture is suitable for dry and damp and wet locations. For use with covered ceiling mount only! (intended for wet locations where the luminaire is not subjected to water and precipitation from the back of the luminaire). To prevent moisture from entering, use clear caulking to seal the space between the fixture mounting bracket and the wall. Ensure that a space is left at the bottom to allow for the escape of moisture. It is recommended that Outdoor Silicon Sealant is used for that purpose.

**WARNING:** Do not install any fixture or assembly (etc.) closer than 6" from any curtain, or similar combustible material.

#### Clothes Closets and Clothes Storage Installation:

**WARNING:** Do not install the Lumenpad fixture or assembly (etc.) in a clothes closets or closet storage space closer than the minimum clearance between the luminaire and the nearest point of a closet storage space per the U.S. National Electrical Code (NEC), ANSI/NFPA 70 Section 410.16 (410.16(A)(1), 410.16(C)(1)(5), and Figure 410.2) as follows:

- 1) no closer than 300 mm (12 in.) installed on the wall above the door or on the ceiling.
- 2) no closer than 600 mm (24 in.) installed on the wall below 1.8 meters (6 feet) or rod height.

Fixture must be installed on a circuit protected by Ground Fault Circuit Interrupter (GFCI). This fixture is designed for use with a circuit protected by a fuse or circuit breaker.

Install LED fixture(s)/LED driver(s) only on their own circuit. Do not mix any other products (Incandescent, Compact Fluorescent, H.I.D. products/fixtures, etc...) with LED fixture(s)/LED driver(s) on a single circuit.

Do not use any other electrical equipment (example: surge protector photocell, etc.) that is not (rated) for use with LED fixture(s)/LED driver(s) on the same circuit as LED fixture(s)/LED driver(s).

Install remote surge protector(s) (by others, goes on the circuit with nothing between the surge protector and the LED fixture(s)/LED driver(s)), if the fixture is not already installed with a surge protector, to help remove power surges that may harm LED fixture(s), appropriate for the installation. Periodically check and make sure that your remote surge protector(s) are in good working order.

#### Maintenance and Care

NOTE: Before installation and/or during maintenance keep fixture on a clean flat surface.

1. Ensure that the power is disconnected prior to cleaning.
2. To keep the finish of this product, wipe over with soft cloth periodically.
3. Do not use harsh chemical solvents, it may discolor or damage the finish.

Technical drawings for illustration purposes only Liton has the right to change any information without prior notice.

### Components / Parts

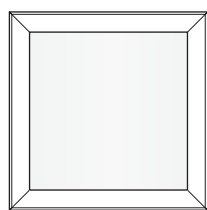

LCMPD-BVL square fixture  
(5" or 7")



Installation Instructions  
(Use Current version on-line)



Hardware Kit  
(Non-dimming)

OR

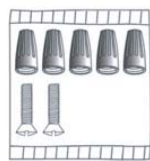

Hardware Kit  
(Dimming)

### Components Dimensions

#### For NON-Dimming fixtures only!

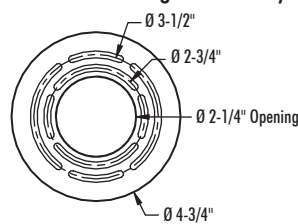

J-box Mounting Plate (For use with #8 screws (MAX) )  
(ALL SLOTS ARE 0.193" WIDE)  
• LCMPD12 (-27, 277V) require's a 4" Octagonal J-box x 2-1/8" deep (Minimum)

#### For Dimming fixtures only!

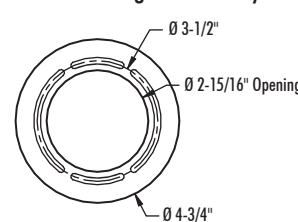

J-box Mounting Plate (For use with #8 screws (MAX) )  
(ALL SLOTS ARE 0.193" WIDE)  
Require's a 4" Octagonal J-box x 2-1/8" deep (Minimum)

### Tools Required

- Phillips Head Screwdriver
- Wire Connectors
- Hardware (by others, screws, nuts, etc.)
- HAND TOOLS AND POWER TOOLS (e.g. Power Drill)



- Hole Saw



- Pencil



- PZ1 Screwdriver Bit



## SAVE THESE INSTRUCTIONS

Keep these instructions in a safe place for future use/reference.

CATALOG #: LCMPD-BVL-5Q/7Q - LumenPad Square LED Downlight Surface Mount

### Installation (Non-Dimming)

### WIRING (Non-Dimming)

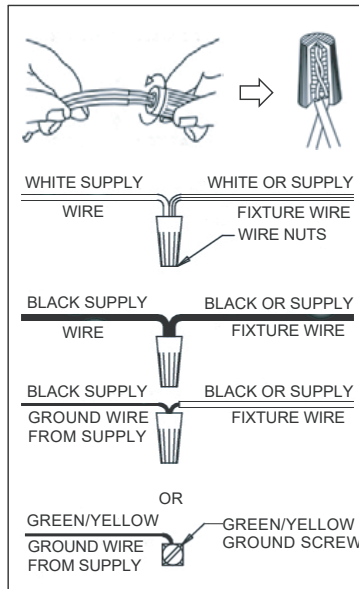
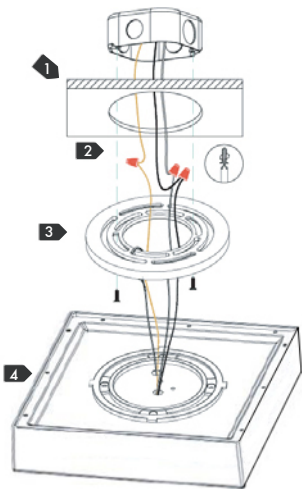

### FIXTURE INSTALLATION

Note: Dimming fixtures require's a 4" Octagonal J-box x 2-1/8" deep (Minimum)

1. Install wiring and j-box in ceiling, if needed.
2. Connect the power supply wiring (from j-box) to fixture wiring in j-box (through j-box mounting plate). See "Wiring" instructions below and right.
3. Connect J-box Mounting Plate to j-box (by others) with appropriate hardware (by others).
4. Secure fixture to mounting plate and rotate to lock fixture in place.

### Installation (Dimming)

Note: Dimming fixtures require's a 4" Octagonal J-box x 2-1/8" deep (Minimum)

### WIRING (Dimming)

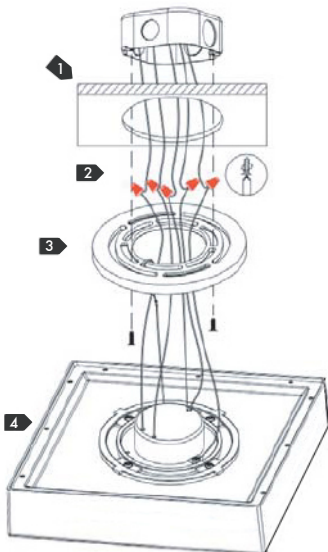

#### A. Install with Dimmer (0-10V) FOLLOW DIMMER WIRING INSTRUCTIONS

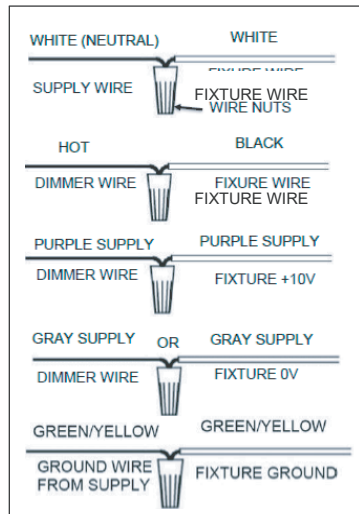

#### B. Install without Dimmer USE WIRE NUTS TO CAP OFF UNUSED PURPLE AND GRAY DIMMER WIRES

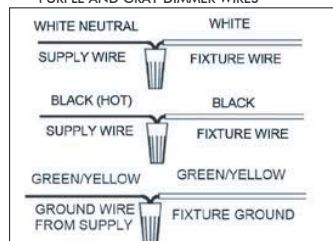

### WIRING

**WARNING:** Do not use Dimming output wires (Purple and Gray) to connect to Power input wires!

**WARNING: RISK OF SHOCK** Make sure that no wires are pinched between j-box mounting plate, j-box & fixture!

**NOTE:** Check fixture for input voltage before connecting power to fixture. Connect wiring in j-box. For dimming and non-dimming wiring information (wiring diagrams, chart, etc.) see LCMPD website page and diagrams at right.

1. Connect ground wire (green or bare copper/aluminum) from the supply circuit to the ground wire (green or bare copper) /screw/connector from the fixture.
2. Connect the neutral (common) wire from the power supply circuit to the neutral wire from the fixture.
3. Connect the main voltage supply wire (line/lead) from the power supply to the line (lead) wire from the fixture.
4. Secure connection using UL Listed wire nuts/connectors and then with UL Listed Electrical tape (by others), as required, appropriate for the connection.

Technical drawings for illustration purposes only Liton has the right to change any information without prior notice.