

CATALOG # : LCALD6" SURFACE MOUNT LUMEN CANNON with LPCM

SAVE THESE INSTRUCTIONS

Keep these instructions in a safe place for future use/reference.

Important: Please read and understand all instructions completely before installing this fixture.

WARNING: Fixture installation (and use) and all electrical connections must be in accordance with local and National Electrical Codes (N.E.C.) rules, regulations and standards. If you are unfamiliar with installing fixture(s), accessories and/or electrical wiring have a qualified licensed electrician install this fixture for you. Fixture should be installed by a qualified electrician.

WARNING: RISK OF SHOCK. House electric current can cause painful shock or serious injury.

WARNING: Always disconnect power before fixture installation, wiring, or maintenance.

WARNING: Before starting the wire connections, disconnect the power by turning off the circuit breaker or removing the fuse at the fuse panel. Turning the power off using the light switch is not sufficient to prevent electrical shock.

This luminaire must be connected with supply wire/conductors rated at 90°C. Most dwellings built before 1985 have supply wire rated at 60°C; consult a qualified electrician before installing.

WARNING: Before service insure fixture is cool to touch.

WARNING: Check fixture for input voltage before connecting power to fixture.

WARNING: RISK OF SHOCK. This fixture is suitable for dry and damp locations. Also for use with covered ceiling mount.

WARNING: Do not install any fixture or assembly (etc.) closer than 6" from any curtain, or similar combustible material.

Fixture must be installed on a circuit protected by Ground Fault Circuit Interrupter (GFCI).

Install LED fixture(s)/LED driver(s) only on their own circuit. Do not mix any other products (Incandescent, Compact Fluorescent, H.I.D. products/fixtures, etc...) with LED fixture(s)/LED driver(s) on a single circuit.

Do not use any other electrical equipment (example: surge protector, photocell, etc.) that is not (rated) for use with LED fixture(s)/LED driver(s) on the same circuit as LED fixture(s)/LED driver(s).

Components / Parts (LPCM only)

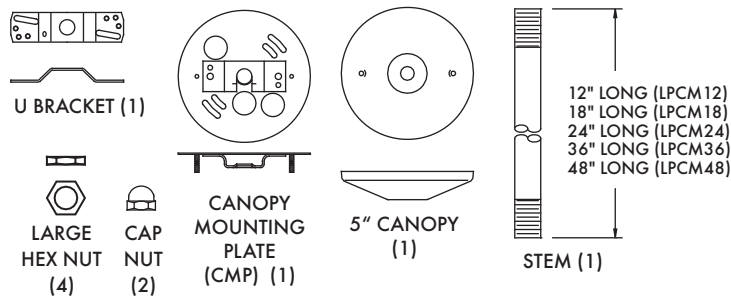

Components Dimensions

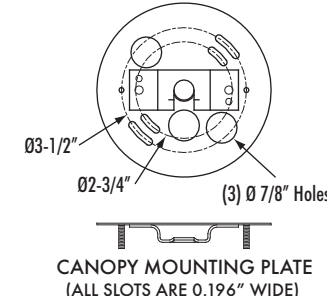

Tools Required

- Phillips Head Screwdriver
- Crescent/Adjustable Wrench(s)
- Wire Connectors/Cord (Rated at 90°C minimum temperature)
- Hardware (screws, nuts, etc.)
- DO NOT USE POWER TOOLS.
- ONLY USE HAND TOOLS.

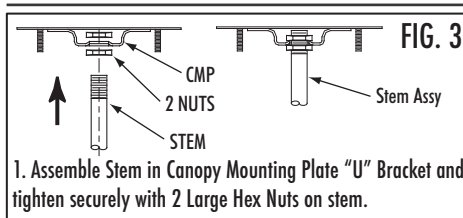

1. Assemble Stem in Canopy Mounting Plate "U" Bracket and tighten securely with 2 Large Hex Nuts on stem.

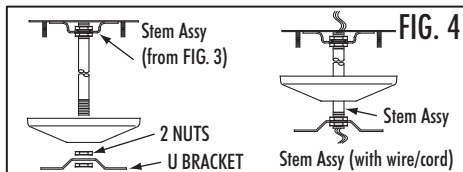

2. Assemble Stem Assy (FIG. 3) through "U" Bracket (with Canopy) and tighten securely using 2 Large Hex Nuts. Insert wires/cord Rated at 90°C (by others) through Stem Assy.

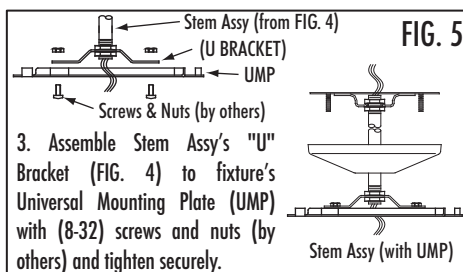

3. Assemble Stem Assy's "U" Bracket (FIG. 4) to fixture's Universal Mounting Plate (UMP) with (8-32) screws and nuts (by others) and tighten securely.

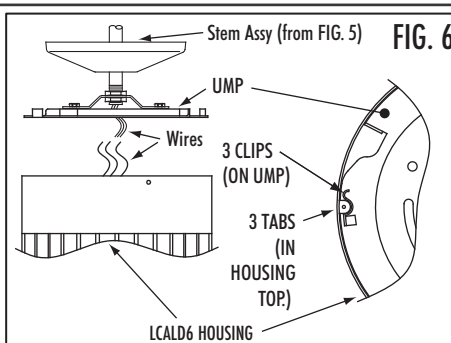

WARNING: Check fixture for input voltage before connecting fixture wires to wires in the stem.

4. Connect wire/conductors in the stem assembly to the fixture wires (ground wire green or bare copper to screw/connector from the fixture, neutral (common) wire in the stem to the neutral wire from the fixture and the line/lead wire in the stem to the line (lead) wire from the fixture).

5. Secure connection using UL Listed wire nuts/connectors and then with UL Listed Electrical tape rated at 90°C (by others, as required), appropriate for the connection.

6. Secure UMP in LCALD6 Housing by putting the three (3) Tabs in the top of the LCALD6 Housing securely in the UMP Clips. Make sure the top of UMP is at the top of the LCALD6 fixture (see FIG. 7).

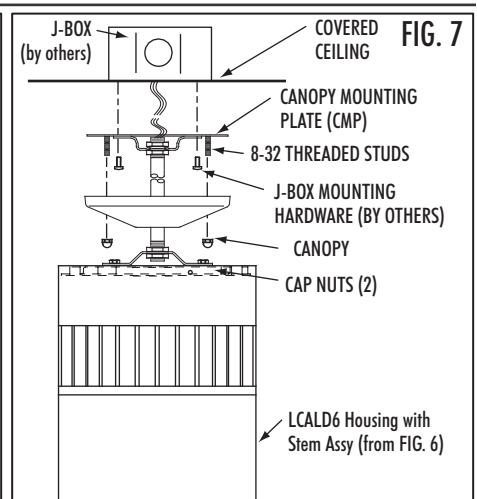

WARNING: Check fixture for input voltage before connecting power to fixture. Connect wiring in j-box.

7. Connect the power supply wiring (from j-box) to fixture wiring in j-box. See "Wiring" instructions page 1.

8. Secure CMP (on Stem Assy with LCALD6 Housing) to Covered Ceiling J-BOX (by others) using J-BOX hardware.

9. Put Canopy up through 8-32 threaded studs in Canopy Mounting Plate (CMP) and secure tightly with supplied two (2) Cap Nuts.

06272017