

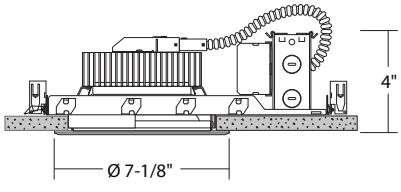

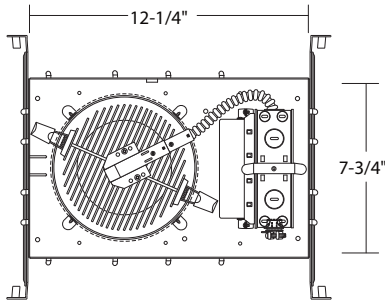





CH6SHL : 6" C-SERIES

SHALLOW LED DOWNLIGHT 2000LM/3000LM (28W/38W)



Ceiling Cut-out: 6-3/8" - Ceiling Thickness: 1" Max



-  Damp Location
-  Wet
-  Intertek
-  120V
-  277V
-  Downlight
-  Emergency Backup
-  CAN BE USED TO COMPLY WITH T24 2016 JA-8 (6)

- Heavy Duty Die-Cast Ring Assembly
- Standard with 0-10V Dimming
- Soft Even Lumen Distribution
- No Visible Screws or Hardware

ORDERING : CH6SHL28UE-D10/CR6SHL22SW-T30

 [Click for Full Specification Details](#)

CH6SHLxx

| Fixture | Lumens | Control | Emergency Options | Reflector Finish | Color Temperature |
|--------------|-----------------|---|--------------------------------------|-------------------------------------|--------------------|
| | Lumens | Control | Emergency Options | Reflector Finish | Color Temperature |
| 2000lm (28W) | CH6SHL28 | 0-10V Dimming (120V/277V) | UE-D10 | Satin Haze Reflector / White Finish | /CR6SHL22SW |
| 3000lm (38W) | CH6SHL38 | DMX Dimming with input via XLR5 (120V/277V) | UE-DMXLR5 | White Reflector /White Finish | /CR6SHL22WW |
| | | DMX Dimming with input via RJ45 (120V/277V) | UE-DMXRJ45 | All Black | /CR6SHL22BB |
| | | | | All Satin Haze | /CR6SHL22SS |
| | | | Emergency Options | | Color Temperature |
| | | | None | | 3000K -T30 |
| | | | 10W Emergency Battery | | 3500K -T35 |
| | | | Full Power Emergency Inverter | | 4000K -T40 |
| | | | Full Power Emergency Inverter (347V) | | |
| | | | GTD Device | | |

¹ Check wiring diagram.

COMPATABILITY

VR800
 Outdoor Vandal Resistant
 Ceiling/Wall Kit



2025.12.11